

Dräger

Your  
Mission  
drives us

**EMERGENCY SERVICES**

Volume 27

Yearbook and Buyer's Guide

Dräger. Technology for Life®

# 4x4 Rescue Pumper

- Marcé 4x4 Rescue Pumper
- Scania P360 Chassis
- Allison automatic transmission
- Ziegler 3000 l/min @ 10 bar normal pressure
- 250 l/min @ 40 bar high pressure
- 3000 liter water tank
- 300 liter Class B foam tank
- Marcé integrated control system
- Marcé pneumatic ladder gantry
- Robotic lightmast
- Remote controlled monitor
- Fully equipped



"Products that **SAVE** lives"

[www.marce.co.za](http://www.marce.co.za) | [sales@marce.co.za](mailto:sales@marce.co.za)





# Emergency Services Yearbook and Buyer's Guide - Volume 27

## CONTENTS

(Date of publication)

**November 2018**

**Emergency Services Yearbook and Buyer's Guide** is published by:

**Delinds Publications cc**  
(reg no CK1990/013388/23)

12 Delta Road  
Blairgowrie  
Randburg

PO Box 72366  
Parkview  
2122

Tel: (011) 886-5985  
Fax: (011) 886-1332  
Cell no: 083 266 6662  
E-mail: delinds@mweb.co.za  
www.emsguide.co.za

**PUBLISHER:**  
Debbie Myer (BA) SA

**EDITOR:**  
Lindsay Myer

**RESEARCH:**  
Thembisa Rasmeni

The publishers are not responsible for any loss or damage to advertising or any material entrusted to them, and reserve the right to edit all contributions. Whilst every effort is made to ensure accuracy in this publication, the publishers, editors and printers do not accept any responsibility for errors or omissions in the content. The publishers and editors are not liable for damages incurred whatsoever by any person, company or entity as a result of action upon any statement contained in this publication.

The opinions expressed do not reflect the policy of the publishers or editors.

The publishers and editors do not endorse nor guarantee any products or claims made by the manufacturers and advertisers.

© 2018. No part of this publication may be reproduced or transmitted in any form or by any means electronic or mechanical including photocopying, recording or by any information storage or retrieval system, without the permission in writing from the publisher.

Breathing Apparatus .....	6
Breathing Air .....	9
Clothing	
Chemical Protection .....	12
Bunker suits .....	16
Apparel, Boots, Gloves .....	17
Hi-Viz .....	19
Fire Protection .....	22
Electric Arc .....	24
Fire Fighting Equipment	
Monitors .....	26
Nozzles .....	28
Foam .....	34
Gas Detection .....	37
Hazard Protection .....	38
Helmets .....	39
Hoses .....	40
Pumps .....	44
Rescue Equipment (Spreaders, cutters, lifting bags, confined space etc) .....	48
Software (Alarming systems, despatch etc) .....	61
Training Aids .....	65
Training Courses .....	
Vehicles (ARFF, pumpers, trailers, turntable ladders etc) .....	82
Advertiser's profiles .....	97
Product cross index .....	109
Trade mark/Brand names cross-index .....	115
Municipal / Provincial Fire Departments .....	117
Industrial Fire Departments .....	144
Department of Defence .....	153
Department of Health .....	154
NDMC Members .....	154
Chaplaincy .....	155
Associations / Institutes .....	156
Index to fire departments .....	157

**BLACK CHERRI Designs**

Shireen Singh  
Mobile: 082 876 8054  
Email: blackcherri.singh@gmail.com

Concept and design of adverts | stationery | point of sale elements  
packaging design | brochures

**COLTRI COMPRESSORS**

HIGH PRESSURE COMPRESSORS FOR PURE BREATHING AIR

tel: 082 449 3576  
fax: 086 459 9433  
email: sales@coltri.co.za  
WWW.COLTRI.CO.ZA

**Chem Systems**

Contact  
André Schütte  
(021) 534-5231  
+27 83 252 1411  
andre.schutte@chemsystems.co.za  
Mason Naidoo - Gauteng  
+27 79 514 6907  
mason.naidoo@chemsystems.co.za  
www.chemsystems.co.za

**Dr. STHAMER HAMBURG** www.sthamer.com

**AECI** good chemistry

**Delinds Publications cc**

Publishers of the Emergency Services Yearbook & Buyer's Guide

Tel: +27 (0)11 886 5985  
Cell: 083 266 6662  
Email: delinds@mweb.co.za  
www.emsguide.co.za

**DESIGNATION HOSE**

INDUSTRIAL HOSES FIRE FIGHTING HOSES FIRE FIGHTING EQUIPMENT CUSTOM MADE HOSES

Chase Remington and Chris Beedle

www.designationhose.com | Email: sales@designationhose.com

16 End Extension Street Johannesburg +27 (11) 791 6730  
www.designationhose.com sales@designationhose.com

**Divetek Compressors**

www.compressors.divetek.co.za

SALES AND SERVICING OF HIGH PRESSURE SYSTEMS

Address: Unit 15, Skyview Retail Park, Cnr CR Swart & Frede Road, Bromhof, JHB, South Africa  
Contact: 011 791 1095  
compressors@divetek.co.za

**dosetech fire**

special risk fire protection

**AKRON FireDos Mueller Co. JONES**

www.dosetech.co.za  
Tel: +27 (0) 861111544  
Mike: +27 (0) 83 251 9346  
Email: mgf@dosetech.co.za

**Dräger**

Tel +27 (0) 11 059 4200  
Visit www.draeger.com

Dräger. Technology for Life®

**DUPONT**

**Nomex.**

Dharmesh Lakmidas  
Tel: +27 (0) 11 218 8686  
Cell: +27 (0) 72 098 0791  
Email: Dharmeh.lakmidas@dupont.com

**DUPONT**

**Tyvek.**

**Tychem.**

Loren Pearson  
Tel: +27 (0) 11 218 8654  
Cell: +27 (0) 82 377 6765  
Email: loren.pearson@dupont.com

www.etsafrica.co.za  
 schedule@etsafrica.co.za  
 info@etsafrica.co.za  
 Tel : +27 16 363 0254 /3  
 +27 16 363 1570  
 Cell: +27 74 347 3771  
 074 (FIRESQ1)  
 Fax : +27 16 363 1550

**LIFE MATTERS**



Emergency Training Solutions

**TRAINING & EMERGENCY TEAM SUPPORT**

**Hamilton Hydraulic Services**

Tel: 011 828 1083 Fax: 011 822 5397  
 Email: hhshurst@netactive.co.za  
 Cell: 082 893 1883  
 Website: www.jawsoflife.co.za



High Performance Fire Fighting Vehicles and Equipment

**Rosenbauer South Africa (Pty) Ltd**  
 Tel: +27 11 805-7912  
 Michael von der Heyde - Mobile: + 27 (0)729255959  
 Email: rosenbauer.za@rosenbauer.com  
 www.rosenbauer.com

Integrated Solutions 

**Sparks & Ellis**

**UNIFORMS**

021 404 1240 | www.sparks.co.za

Specialising in Fire, Fire Servicing and Safety, as well as Drug and Alcohol Testers



Tel no: +27 11 908 6960 / 864 5945  
 Email: duncan@firebreaksa.co.za / blane@firebreaksa.co.za  
 Web Site : www.firebreaksa.co.za

**FIREBREAK SA**  
 SAFETY APPLIANCES PTY LTD



**holmatro**  
 mastering power

Unit 18, Saligna Park 3 Saligna Road Witfield 1459  
 T +27-82 609 3438 E johan@trtg.co.za

www.trtg.co.za



T: +27 (11) 300 3300  
 0861 SYSMAN (797/626)  
 F: +27 (11) 219 7430 e-fax  
 +27 (11) 300 3315  
 W: www.sysman.co.za

Sysman Park, 69 Buitfontein Rd,  
 Lanseria, Gauteng, South Africa  
 PO Box 539, Lanseria, 1748  
 25°57'51.94" S / 27°56'53.06" E



Jaco Keet  
 Sales Manager  
 Emergency Vehicles

TFM Industries (Pty) Ltd  
 33 Industry Road  
 Clayville x 4  
 Olifantsfontein  
 Cell: +27 82 450 2256  
 Tel: +27 11 316 2620  
 Email: jacok@tfm.co.za

**The Future of Emergency Vehicles**

**Fire Protection Association of Southern Africa**



PO Box 15467 Impala Park 1472  
 Springbok Road Bartlett Boksburg  
 Tel: (011) 397-1618  
 Satellite Tel: (011) 552-6908  
 Fax: (011) 397-1160

www.fpsa.co.za



**Marce**  
 FIRE FIGHTING TECHNOLOGY

Address  
 1012 Ergon Street  
 Lyttelton, Centurion  
 Gauteng, South Africa

Web  
 sales@marce.co.za  
 www.marce.co.za  
 +27 12 742 9200

Marcé  
 Excellence Through Innovation

The oldest occupational health and safety association in South Africa

**Celebrating over 80 years of safety**

Posters  
 Induction booklets  
 Journal  
 Informative books



Safety Audits  
 Conferences  
 Training

Tel: +27 11 701-5054 Email: admin@safety1st.co.za  
 www.safety1st.co.za

Sales Director  
 Johan Muller  
 + 27 82 609 3438  
 + 27 11 823 2481  
 johan@trtg.co.za

www.holmatro.com

Service Director  
 Romeo Letageng  
 + 27 79 880 5251  
 + 27 11 823 1927  
 romeo@trtg.co.za



Suppliers of Holmatro Rescue Equipment - world-class hydraulic rescue equipment  
 Excellent after sales service

For all your training and equipment needs

**FREMTAC**  
 FIRE AND RESCUE CC

Jimmy Croucamp  
 Mobile: + 27 82 412 6319  
 Email: jimmy.c@fremtac.com

www.fremtac.com

**OSHAfrica 2019 Conference**

18 - 20 September 2019

Emperors Palace Convention Centre, Ekurhuleni, South Africa

www.oshafrica2019.com



Conference and Exhibition  
 Emperors Palace, Johannesburg, South Africa  
 18 - 20 September 2019

OCCUPATIONAL HEALTH AND SAFETY IN AFRICA  
 CHALLENGES AND ACTIONS



Manufacturers and Suppliers of Reflective High-Visibility Clothing and Tape

Tel: 27(0)11 493 7608  
 Fax: 27(0)11 493 7940

70 Webber St, Selby  
 Johannesburg, South Africa  
 P.O. Box 62474, Marshalltown, 2107, SA



**VANGUARD FIRE & SAFETY**



Facebook.com/Vanguardfs Twitter: twitter.com/@vanguardfs

Durban: +27 31 564-3200 Port Elizabeth: +27 41 451-2461  
 Email: info@vanguardafrica.co.za / www.vanguardfire.co.za

**GODIVA**

Daniel Janse van Rensburg - Regional Manager - Africa  
 South African Mobile: +27 (0) 83 263 1796  
 Email: godiva.africa@idexcorp.com / Skype: danielvr50  
 Website: www.godiva.co.uk / Website: www.haleproducts.com



**RESCUE SOUTH AFRICA**



DISASTER RESPONSE.  
 URBAN SEARCH AND RESCUE.  
 ANYTIME.  
 ANYWHERE IN THE WORLD

Ian Scher +27 11 234 1545/ +27 82 459 9765 ian@rescue-sa.co.za  
 Website: www.rescue-sa.co.za

Specialised training products for the ambulance, rescue and emergency services

On-line learning  
 Distant learning



Learn - Develop - Succeed

Tel: 011-467-2730  
 Fax: 011-467-3313 / 0866077690  
 Cell: 082 552 774 Email: linda@skillstrain.co.za  
 www.skillstrain.co.za / www.skillstrainlms.co.za



Download additional copies or past issues of

**THE EMERGENCY SERVICES YEARBOOK & BUYER'S GUIDE**

from [www.emsguide.co.za](http://www.emsguide.co.za)



Designed to  
**go through**  
fire with you.



**The new Dräger PSS® 5000 compressed air breathing apparatus**

No matter what danger you are faced with: the new Dräger PSS 5000 adapts to your operational conditions. You can select from two harnesses: the basic Dräger Standard (DS) variant and the Dräger Professional (DP), which is particularly robust and offers maximum comfort. To avoid snagging, medium and high-pressure lines are integrated in the back plate.

The hoses can be individually routed over the left or right shoulder. The prevention of excessive dirt and water ingress and the ease of dismantling without the need for additional tools results in a harness which is easy to clean and decontaminate and keeps maintenance downtime to a minimum.

Within a short time, your Dräger PSS 5000 is ready for the next challenge. [www.draeger.com](http://www.draeger.com)

Dräger. Technology for Life®



**INCURVE™**

**INSPIRE™**

**INCURVE** breathing apparatus with the brand new unique harness. The harness has a minimum of textiles which makes it easy to clean, it is robust and lightweight and has an outstanding comfort!

**INSPIRE** full face mask, has the same innovative features as the S-mask and also a convenient quick connection for easy removal and connection of the breathing valve to the mask.

**JIMMY CROUCAMP**

Mobile: +2782 412 6319  
Email: [jimmy.c@fremtac.com](mailto:jimmy.c@fremtac.com)  
[www.fremtac.com](http://www.fremtac.com)



**QS II** is a product platform based on high performance system products that can be adapted for different needs.

The harness concept is combined with the proven performance of the Interspiro pressure regulator and breathing valve.

**QS II** is available for single cylinder, twin cylinders and cylinder pack.

# Emergency Advanced Breathing Apparatus

## The future of SCBA



Full face mask  
HUD display  
Kevlar head net - Flame retardant

Carbon Composite Full Cylinder  
Aluminium alloy liner  
6.8L cylinders available  
300 bar

Back Pack  
High intensity material  
Anti-static, isolates high temp  
Reflective strips

Double-Quick Connector  
Self-locking function

Buddy-breathing device

PASS Unit  
Automatically activated after 30 seconds of non-motion

Comms Speaker

Demand valve  
360 degree quick join  
Activate comms speaker  
as well as donning switch  
Manual PASS activation

Pressure Indicator  
Indicating cylinder pressure standard  
on all SCBA units



### HUD - Heads Up Display

With Marcé's unique HUD located in the demand valve. Firefighters can monitor cylinder pressure, current time, direction as well as atmospheric temperature.



For more information pricing or a demonstration  
contact Marcé at +27 12 742 9200  
sales@marce.co.za  
www.marce.co.za



## HIGH PRESSURE COMPRESSORS FOR PURE BREATHING AIR

The Aerotecnica Coltri® range includes portable compressors and large filling stations driven by single or three-phase electric motors; petrol and diesel powered variants are also available.



Distributed by  
COLTRI SOUTH AFRICA  
Cell: +27 82 449 3576  
Email: steve@coltri.co.za  
Fax: 086 4599433  
Tel: 082 449 3576

[WWW.COLTRI.CO.ZA](http://WWW.COLTRI.CO.ZA)

# Divetek Compressors

[compressors.divetek.co.za](http://compressors.divetek.co.za)

SALES AND SERVICING OF HIGH PRESSURE SYSTEMS



Breathing Air & Recreational SCUBA Diving



Paintball



Fire Fighting



Breathing Air & Industrial Air



Commercial Diving

## ABOUT US

Divetek Compressors not only supplies High Pressure Equipment to local Sub-Saharan African Industries from overseas but, over the years have designed, developed and manufactured a number of installations to suit the specific needs of the client.

Our technicians have approximately 35 years of experience within the industry, from sales, to installations as well as service and maintenance of high pressure applications.

## SALES

We have the right High Pressure Compressors for any job. Whether it be for Industrial use or a simple breathing air compressor for SCUBA applications.

## SERVICE AND MAINTENANCE

We provide competitive service and maintenance to all high pressure applications and installations.

## INSTALLATIONS

Our team of experienced technicians are capable of providing expert advice & handling of any high pressure compressor installations.

## CYLINDERS

Our team has extensive knowledge regarding both cylinder sales as well as the required service intervals and filling for both air and O2 Cylinders.

## SCUBA EQUIPMENT

We can assist with all your SCUBA gear as well as provide OTS Full face masks & military underwater comms systems.



INFINITE SOLUTIONS FOR HIGH PRESSURE APPLICATIONS

## CASCADE SYSTEMS

Our team have also been involved in many projects involving cascade systems, installation of filling panels and storage solutions.

## SURFACE SUPPLY UNITS

Our team can assist with sales, service and maintenance as well as expert advice for surface supply units for commercial use.

## IMPORTERS & DISTRIBUTERS

We import and distribute the following International brands: Luxfer, Faber, Midland, San-o-Sub, Paramina, Nuvaair and more.

## TRAINING & CERTIFICATION

Our technicians can also provide on-site training and certification for Compressor Operators & maintenance.

## UNDERWATER LIGHTING SYSTEMS

We have specialised underwater lighting systems from cannister lights to hands-free head lights.

Address: Unit 15,  
Skyview Retail Park,  
Cnr CR Swart &  
Freda Road,  
Bromhof, JHB,  
South Africa

**Divetek  Compressors**  
[compressors.divetek.co.za](http://compressors.divetek.co.za)  
Contact: 011 791 1095  
[compressors@divetek.co.za](mailto:compressors@divetek.co.za)

  
**DIVETEK**  
[www.divetek.co.za](http://www.divetek.co.za)

Safe is not enough:  
**5-fold safety**  
against **extreme hazards.**



### The chemical protection suit Dräger CPS 7900

No matter whether handling cryogenic substances or working in potentially explosive areas: you can rely on your gas-tight Dräger CPS 7900 in numerous operations involving hazardous substances. The suit's innovative material called D-mex™ consists of five layers and is uniquely resistant to industrial chemicals, warfare agents and other hazardous substances. It is also resistant to mechanical wear, liquefied gases and bursts of flames. Safety is also paramount when it comes to the accessories: from the pressure gauge holder to length adjustment, the Dräger CPS 7900 is the perfect choice. [www.draeger.com](http://www.draeger.com)

Dräger. Technology for Life®



## WHEN THE RESPONSIBILITY OF KEEPING OTHERS SAFE RESTS ON YOUR SHOULDERS

Premium protection against toxic, corrosive, gaseous, liquid and solid chemicals

For further information contact  
Loren Pearson Cell: +27 (0)82 377 6765  
Tél: +27 (0) 11 218 8654  
Email: [loren.pearson@dupont.com](mailto:loren.pearson@dupont.com)  
[www.Safespec.dupont.co.uk](http://www.Safespec.dupont.co.uk)





**Level A Gas Tight total encapsulating chemical protective suit**  
*For the highest level of protection*

**Chemical protective clothing, Category III**

**Overview of Tychem® TK advantages**

- Gas-tight, very good chemical barrier qualities
- Lightweight, soft and flexible
- Good material durability and tear resistance
- Highly visible lemon yellow colour
- Permanent physical properties that work in a wide variety of temperatures
- Permeation data available for many chemicals
- Available with integrated chemical protection boots or boot socks with splash protection
- Sizes S - XXL



**When worker safety comes first**

**... and the responsibility of others rests on your shoulders**



**Tychem® F chemical protective suit for first responders**

*For the highest protection against chemical challenges*

- Strong and durable with broad chemical barrier
- Provides at least 30 minutes of protection against 181 chemicals
- Grey for discretionary purposes

**TYCHEM® THERMOPRO**

*Provides triple hazard protection from chemicals, flash fire and electric arc, combining the trusted chemical protection of DuPont™ Tychem® with the flame and arc flash protection of DuPont™ Nomex® into a single garment.*



**TYCHEM® BR / TYCHEM® LV**

*Broad protection for hazardous materials handlers*



Please contact Firebreak to arrange a free demonstration. We also supply SCBA sets, fire helmets, airline respirators, fire boots, fire gloves, balaclavas, fire fighting equipment and gas detectors.



**FOR HIGH VISIBILITY THAT DOESN'T WASH OUT**  
**Tyvek® 500 HV**

**Tychem® QC for superior protection against biohazards**

*One of the most comfortable protective garments available.*

- Light liquid splash protection
- Flexible, durable, lightweight
- At least 30 minutes of protection against 42 chemicals
- Yellow for high visibility



**Universal pressure kit**

*Designed for periodic air pressure testing on all Level A fully encapsulated suits*

- Compact lightweight
- Completely self-contained
- Requires no external air supply



**FIREBREAK SA**  
 SAFETY APPLIANCES PTY LTD

Certified Level 1 BBEEE Contributor

Tel No : +27 11 908 6960 / 864 5945  
 Web Site : [www.firebreaksa.co.za](http://www.firebreaksa.co.za)  
**FIREBREAK SA**  
 SAFETY APPLIANCES PTY LTD



Tel No: +27 11 908 6960 / 864 5945  
 Web Site : [www.firebreaksa.co.za](http://www.firebreaksa.co.za)

# Marcé Fire Fighting

## Structural Fire Fighting Suit EN137:2006 Certified

### Material

- Outer : K -HM02, 240g, Rip-stop
- Moisture : F100SLPTFE
- Thermal Barrier: K-GORNOX
- Inner: M-ST02

### Coat

- Safety throat tab secures the closure and prevents liquids from entering.
- A convenient wire pocket and an inside pocket on the left chest.
- Two sewed on solid pockets in the front, with reflective tapes across the body of the pockets.
- Anti-wicking strips inside at the end of the sleeves and hem.
- Inside collar loop for easy hanging and thumb loops on the wristlets for preventing items from entering.

### Trousers

- Cross braces design with adjustable braces buckles and side buckles for comfortable fixation.
- Heavy duty zipper fastens the front opening. It is covered by a storm flap with hook and loop fastener
- Extra reinforcement padding on the knees.
- Anti-wicking strips inside at the end of the pant.
- Inside pocket on the right hip.

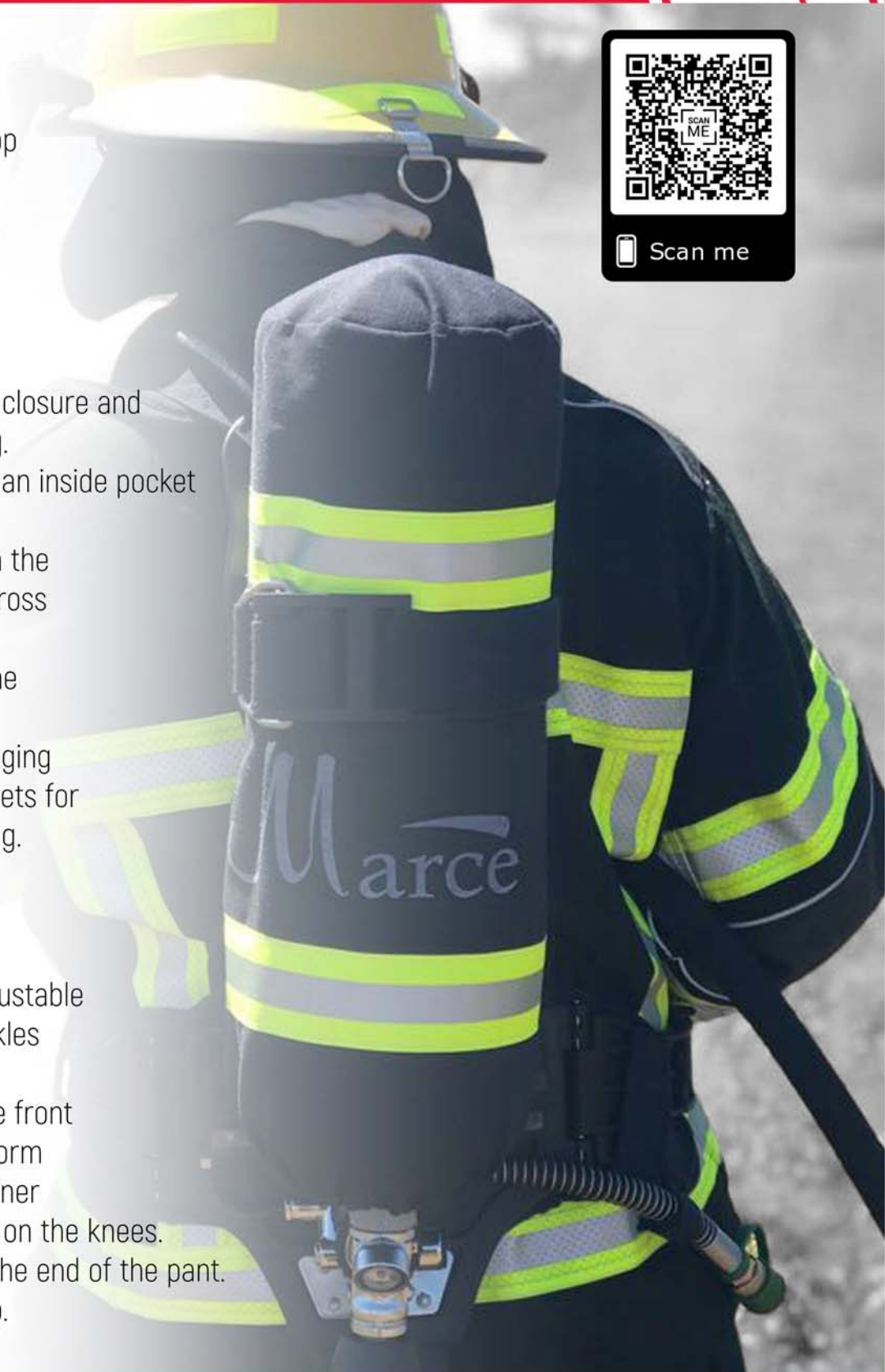

# Marcé Fire Fighting

## Boots & Gloves



Dragon Fire - Alpha X NFA  
Full and complete natural leather



NFA Certified 1971 Standard

### Safety

Excellent cut / rip / abrasion resistant

### Design

Overall anatomically correct ergonomic design



### NFA Flash Hood

Economical option, inherent flame resistant, no harsh chemical treatments, maintains performance values after laundering. Light weight

NFA Certified 1971-2013 Standard

### Extra Protection

Ankle protection



### Grips

Functional grips for easy pull on

### Protection

Steel toe cap

### Marcé Leather Fire Fighting Boots

Full-grained waterproof leather  
Steel toe cap  
Puncture-resistant steel midsole  
Snug-fitting, soft lining made from real leather  
Full-length, removable SECURA CARE insole  
EN 15090:2012 F2A SRC H13 Certified

"Products that SAVE lives"

www.marce.co.za | sales@marce.co.za



"Products that SAVE lives"

www.marce.co.za | sales@marce.co.za



**FLASH HOOD**

**FH33** Uncompromised protection in a lightweight design



- Keeps skin drier
- Nomex/Lenzing FR blend
- Easy seal face opening
- 100% stretch to fit SCBA masks and goggles



**HySafety**

**STRUCTURAL FIREFIGHTING GLOVE**

**HSG 7888**

Long lasting water repellency and superior softness

NFPA 1971-2013 Certified

Thermo Cowhide leather outer shell

Fire-retardant fleece liner

Moisture barrier prevents liquid penetration of chemicals and blood-borne pathogens



**HySafety**

**WILDLAND FIREFIGHTING GLOVE**

**7986**

Ensures hands are well protected against the rigorous conditions of wildfire operations

Heat and flame resistant

Gold Eversoft cowhide shell construction

Retains soft characteristics after getting wet and dry

Resists cracking, peeling and getting slippery when wet



Manufacturers and Suppliers of Reflective High-Visibility Clothing and Tape



EMS collar jacket



EMS rain coat

EMS rain trousers



**FIREFIGHTER BOOTS (NFPA CERTIFIED)**

**VW91**

"Snug Fit" design creates a supportive boot, with tighter fit to prevent ankle roll over and foot fatigue

- Kevlar lining
- Steel toe and mid-sole
- Electric shock resistance 18kV
- Flame retardant rubber upper
- Blood-borne pathogens viral protective upper



Find out more: [www.vanguardfire.co.za](http://www.vanguardfire.co.za)

Tel: +27 (0) 31 564 3200 Tel: +27 (0) 41 451 2461 Email: [info@vanguardafrica.co.za](mailto:info@vanguardafrica.co.za)



**Johannesburg**

+27(0)11 493 7608  
+27(0)86 603 7628

70 Webber Street, Selby, Johannesburg, South Africa



# Sparks & Ellis

## UNIFORMS

### Let Sparks light up the situation



This **SWAT** law enforcement flashlight's strobe effect allows security and law enforcement officers to shine a light on criminals or dangerous individuals in low light or dark condition. It is robust enough to withstand any amount of man-handling. Easy to operate, with five mode settings, including a whopping 900 lumens on full power. The **SWAT** flashlight has rechargeable Lithium-ion batteries with an alternative power source option which makes use of normal disposable batteries. This means that you need never be in the dark! It has a military spec casing and a super strong aluminium alloy body which makes it impact resistant when dropped from a height of 1.5m. It is weather resistant and the 100 000 hour lifetime Cree 10 watt LED means that this flashlight's lifespan is a lot longer than conventional globes. The **SWAT**'s built-in energy management system also gives it longer battery life. All round, you'd feel pretty secure in buying the SWAT flashlight, knowing that it's effective in compromising situations, strong enough to last the night and, importantly, it's good value for money as it's such a quality product. Sparks & Ellis is now offering these as part of our total security/law enforcement uniforms and combat gear offering.

**Sparks & Ellis Uniforms** one of South Africa's leading uniform suppliers and manufacturers



AN ASSOCIATE OF THE  
THEBE GROUP

has branches in Cape Town, Johannesburg, Durban and Port Elizabeth.  
www.sparks.co.za  
Tel: 021 404 1240  
Email: info@sparks.co.za

### Lumi-viz



Retro reflective tape and letters

Lumi-viz tape and badge in total darkness

Traffic officers, fire fighters, emergency medical staff, construction workers, miners, in fact anyone who needs to be seen, are vulnerable if they are not clearly visible in all light conditions.

Conventional safety clothing usually aims to be conspicuous by the following means:-

**Day time visibility** – brightly coloured hi-vis dayglo yellow or orange fluorescent fabrics or trims. Effective only in bright light.

**Night time visibility** – retro reflective tape which reflects light back to the source e.g. cars headlights or a flashlight. Needs a light source from the right direction to be effective.

The problem is that neither of the above work at all in total darkness or, for example, where a vehicle approaches a roadblock or accident scene without its headlights on.

Introducing **Lumi-viz®**, a unique luminous tape that absorbs light from the sun, daylight or even normal home or office lighting. This absorbed light is given off for up to 10 hours making the wearer visible even in total darkness.

Sparks & Ellis, one of South Africa's leading uniform suppliers, are at the forefront of this new technology which offers a whole new level of safety for your workforce.

Sparks & Ellis has developed this tape in order to provide extra safety for people who need to be seen in all light conditions. **Lumi-viz™** tape can be stitched onto garments during manufacture and can be used as a background fabric for badges. It is a highly effective and affordable way of improving safety of your protective clothing.

## GET INTO THE RIGHT GEAR

**WHO WOULD YOU TRUST TO DO THE JOB?**  
ALEX CLOWNING AROUND AT HIS KIDS FOURTH BIRTHDAY PARTY?



**ALEX IN THE RIGHT GEAR?**



# Sparks & Ellis

## UNIFORMS

021 404 1240 | www.sparks.co.za

A member of the Cape Union Mart Group of Companies  
empowered by Thebe Investment Corporation

Sparks & Ellis is a Level 1 Bee Certified company which specialises in complete uniform solutions and offers clients a head-to-toe service, developing technologically advanced products, Sparks & Ellis Uniforms has branches in Cape Town, Johannesburg, Durban and Port Elizabeth.

TRUSTED  
AROUND  
THE WORLD

Nomex.  
NEVER QUIT.™



For further information contact:  
Dharmesh Lakmidas Cell: +27 (0) 72 098 0791  
Tel: +27 (0) 11 218 8686  
Email: Dharmesh.lakmidas@dupont.com  
www.safespec.nomex.ae

Fire and electric flash are unpredictable. And deadly. That's why workers who face on-the-job threats of fire and electric arc hazards rely on thermal apparel made with DuPont™ Nomex®. The inherent heat and flame resistance of Nomex® fiber is protection that can't be washed out or worn away. The reliable performance is an essential safeguard for emergency responders, military and industrial workers around the world who trust Nomex® to bring them home safe.



Nomex  
NEVER QUIT.™

www.nomex.com



For further information contact:  
Dharmesh Lakmidas Cell: +27 (0) 72 098 0791  
Tel: +27 (0) 11 218 8686  
Email: Dharmesh.lakmidas@dupont.com  
www.safespec.nomex.ae



Nomex.

DuPont™ Nomex®.  
YOUR SAFETY, OUR SUPPORT

Find out how DuPont™ Nomex® is the safe choice offering the peace of mind you deserve.  
For more information, visit [www.safespec.nomex.ae](http://www.safespec.nomex.ae)



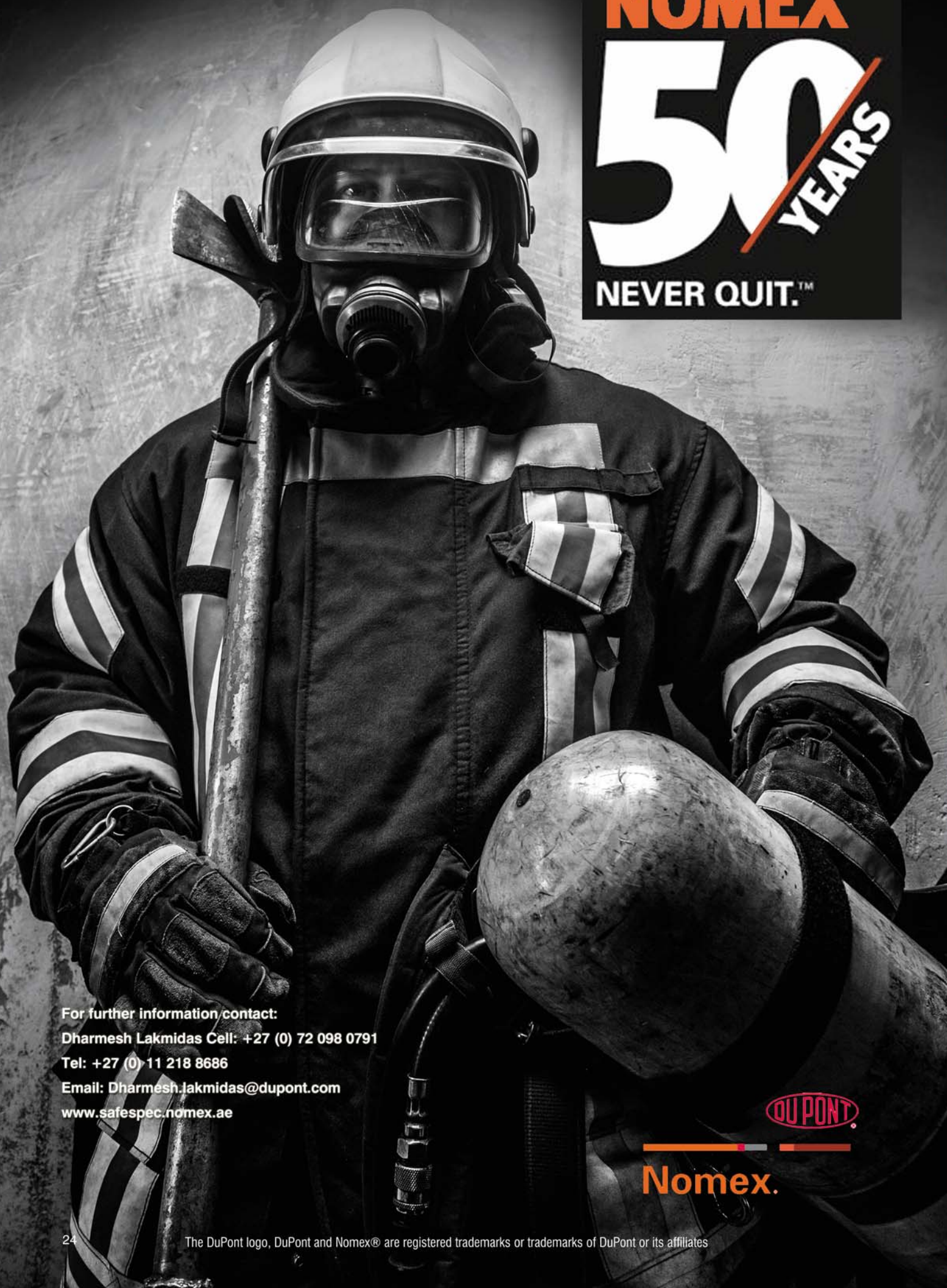

**NOMEX**  
**50** YEARS  
**NEVER QUIT.™**

For further information contact:  
Dharmesh Lakmidas Cell: +27 (0) 72 098 0791  
Tel: +27 (0) 11 218 8686  
Email: Dharmesh.lakmidas@dupont.com  
www.safespec.nomex.ae



**Nomex.**

The DuPont logo, DuPont and Nomex® are registered trademarks or trademarks of DuPont or its affiliates



## DuPont™ Tychem® ThermoPro

A SINGLE LAYER TRIPLE THREAT PROTECTIVE GARMENT THAT RESISTS CHEMICALS WHILE ALSO PROVIDING FLASH FIRE ESCAPE AND ELECTRIC ARC PROTECTION



### Emergency responders and industrial workers deserve the latest innovation in proven protection.

To protect others, emergency responders need the best protection for themselves. Whether responding to a traffic accident or containing an industrial emergency, responders need a garment that will protect them from many hazards. Industrial workers facing the possible hazards of a flash fire, electrical arc flash, and chemical exposure need a single garment with multiple types of protection. Choosing the best garment also means considering many other factors, like comfort, durability, cost effectiveness and safety. For these reasons, and others, DuPont has taken 40 years of industrial chemical and firefighting technology experience and innovation and created a single-layer suit—DuPont™ Tychem® ThermoPro.

For further information contact  
Loren Pearson Cell: +27 (0)82 377 6765  
Tel: +27 (0) 11 218 8654  
Email: loren.pearson@dupont.com  
www.Safespec.dupont.co.uk

The DuPont logo, DuPont™ and Tychem® are registered trademarks or trademarks of DuPont or its affiliates

# Marcé Fire Fighting Mamba Monitor Range

6000 l/min @ 10 bar

Manually or electrically controlled

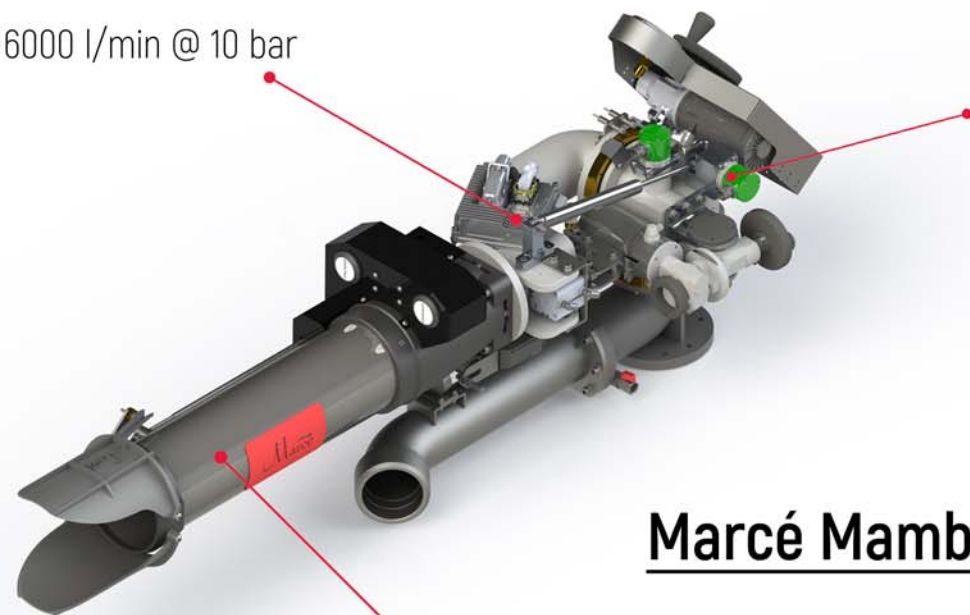

Full aspiration

## Marcé Mamba 6 Monitor

The Mamba 6 is a fully aspirated turret which meets the highest standards required by fire fighting departments with a flow rate of 6000 l/min @ full flow and 3000 l/min @ half flow.

## Marcé Mamba 3 Monitor

The Mamba 3 bumper turret meets the highest standards required by fire fighting departments with a flow rate of 3000 l/min.



Electronically Controlled

3000 l/min @ 10 bar



Scan me

Developed and manufactured  
in South Africa

[www.marce.co.za](http://www.marce.co.za) | [sales@marce.co.za](mailto:sales@marce.co.za)



## TASK FORCE TIPS, INC.



2351 Industrial Drive, Valparaiso, IN 46383-9577 USA  
International +1.219.548.4000 • [www.tft.com](http://www.tft.com) • [intsales@tft.com](mailto:intsales@tft.com)

## Portable Monitors

400-2000 l/min or  
1100-4500 l/min



## BLITZ LITE

400-2000 l/min Portable Monitor

The Blitz Lite is an efficient, compact and easy to maneuver portable monitor. The monitor is a lightweight aluminum unit, which can deliver 2000 l/min of water. This monitor can be mounted in a pre-connected on the truck-mounting bracket, for achieving quick and effective initial attack. The Blitz Lite's discharge pivots make directing the stream extremely quick and effortless. An anchor strap is built-in for safe operation.

- Hydrant-type Ball Valve
- Flow is ON or OFF, locks in Position
- Elevation 20° - 60° Unmanned

## BLITZFIRE OSC

400-2000 l/min Portable Monitor

Blitzfire is a simple, light, and highly maneuverable attack monitor. It can go anywhere a handline goes while delivering much more water. If the Blitzfire starts to slide or lift, the **SAFETY SHUT-OFF VALVE** automatically shuts off the flow of water. The Oscillation option allows for a 20°, 30° or 40° auto sweep. The Blitzfire's discharge pivots make directing the stream extremely quick and effortless. A unique up/down pivot on the hose inlet allows the monitor to have stability even on porches and stair landings. An anchor strap is included for safe operation on slick surfaces like marble floors.

- Slide Valve with 6 Detent Flow Positions
- Self Leveling Inlet and Easy Adjust Discharge
- Elevation 10° - 50° Unmanned

## CROSSFIRE

1100-4500 l/min Portable Monitor

The CROSSFIRE monitor is the most versatile master stream appliance ever offered to the fire service. Its lightweight, compact design and unique quick-release swivel joint allow for a faster and safer stream deployment in the portable attack mode. The Safe-Tak 1250 utilizes the revolutionary, patented Safe-Tak "flow safety valve." Should the monitor lose contact with the ground surface, the **Safe-Tak will automatically reduce flow to the monitor.**

- Stainless Steel Legs with Carbide Tip Spikes
- Quick Connect Top with Positive Lock
- Automatic Drain
- Multiple Inlets to fit Your Department Operations



For excellent quality fire fighting equipment visit [www.tft.com](http://www.tft.com) and call your local distributor for a demonstration. Display equipment, literature and digital data can be obtained by contacting your trained TFT distributor.

Durban: +27 31 564-3200 / Port Elizabeth: +27 41 451-2461

Email: [info@vanguardafrica.co.za](mailto:info@vanguardafrica.co.za)  
[www.vanguardfire.co.za](http://www.vanguardfire.co.za) / [www.tft.com](http://www.tft.com)



Like us on Facebook: [facebook.com/Vanguardfs](https://www.facebook.com/Vanguardfs)



Follow us on Twitter: [twitter.com/vanguardfs](https://twitter.com/vanguardfs)



# Marcé Fire Fighting

## Fire Fighting Nozzles



- Warrior Nozzle NP 115 - 450**
- Strong light weight aluminium construction with a flow rate of 115 - 230 - 360 - 450 Litres per min @ 7 bar.
  - Jet Stream and 130 degree wide fog pattern with constant selectable flow rate.
  - Available with STORZ, BIC and NST couplings.



- Warrior Nozzle NP 350 - 950**
- Strong light weight aluminium construction with a flow rate of 350 - 450 - 580 - 780 - 950 Litres per min @ 7 bar.
  - Jet Stream and 130 degree wide fog pattern with constant selectable flow rate.
  - Available with STORZ, BIC and NST couplings.



- Warrior CAFS Nozzle**
- Strong light weight aluminium construction with a working pressure of 7 bar.
  - Multi-functional nozzle.
  - Available with STORZ, BIC and NST couplings.
  - When in flip down position, the nozzle can reach a maximum flow to spray compressed air foam.
  - When in flip up position, there are 3 jet types Jet-Fog-Flush.



Scan me

*"Products that SAVE lives"*

www.marce.co.za | sales@marce.co.za



# HIGH PERFORMANCE NOZZLES



**Your Choice Of...**

- Automatic - 230-570 l/min
- Selectable - 110, 230, 360, 470, & 570 l/min
- Fixed l/min - 570 l/min

**Your Choice Of...**

- Fixed Metal
- Fixed Rubber
- Stainless Steel Spinning Teeth

**Every G-force Nozzle Delivers These Standard Features:**

- 7 bar and low pressure models
- Turbulence free stainless steel slide valve design and integrated debris screen
- All models are made in the U.S.A., are serialized, have reflective labeling, permanent laser markings and 5-year warranty

www.facebook.com/vanguardfs  
www.twitter.com/@vanguardfs

**TASK FORCE TIPS®**  
FIRE FIGHTING EQUIPMENT



TFT.com



info@vanguardafrica.co.za

www.vanguardfire.co.za

Durban: +27 (0)31 564 3200

Port Elizabeth: +27 (0)41 451 2461





FireDos foam dosing pumps and systems Monitors and water cannons Mobile dosing and monitor systems Bund and tank top pour ers

**dosetech fire**  
special risk fire protection

+27 (0) 861 111 544  
sales@dosetech.co.za  
mgf@dosetech.co.za  
www.dosetech.co.za



Hand line nozzles Mueller gate valves, indicator posts and fire protection control valves Jones hydrants Foam concentrate



**FireDos®**

Foam Dosing System For Stationary & Mobile Extinguishing Systems



High Volume Monitors For Fire Fighting



Monitors For Remote Control



**dosetech fire**  
special risk fire protection

**Mueller Co.**

Reliable Connections™

Pressure Reduce Relief, Flow & Level Control Deluge Valve



Resilient Wedge Gate Valve OS & Y



Dome Top Fire Hydrant



**dosetech fire**  
special risk fire protection

**AKRON**  
BRASS COMPANY

Monitors, Water Canons for Fire Protection and Industrial Applications



ProVenger Nozzles



Oscillating Flange To Automate



**dosetech fire**  
special risk fire protection

# DESIGNATION HOSE



## OUR PRODUCTS



**INDUSTRIAL HOSES**

Compressed air, water pump, hydraulics, mining hoses and other



**FIRE FIGHTING HOSES**

Fire fighting, forestry, high-rises and cabinet hoses



**FIRE FIGHTING EQUIPMENT**

Nozzles, Monitors and other fire fighting equipment



**CUSTOM MADE HOISING**

Custom-made hosing to suit clients needs

**GOMTEX®**

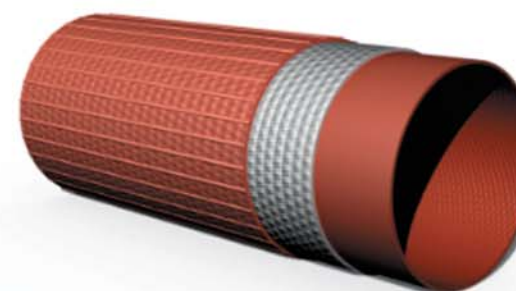

High performance hose extruded in a single process.

TECHNICAL CHARACTERISTICS

DIAMETER		WEIGHT	THICKNESS	WORKING PRESSURE	BREAKAGE PRESSURE
Inches	mm.	gr/m	mm.	Bars	Bars
1"	25	250	1,95	67	>90
?	32	310	2,0	27	>80
?	38	345	1,95	21	>62
?	42	395	2,1	20	>60
?	45	410	1,9	21	>62
?	52	460	2,0	20	>60
?	55	470	2,0	17	>52
?	64	600	2,1	17	>52
?	70	680	2,3	17	>50
?	75	790	2,5	17	>50
?	80	810	2,25	15	>45
?	90	930	2,35	15	>45
?	102	1.030	2,5	17	>52

**ATLAS®**



CONVENTIONAL HOSE WITH SIMPLE HIGH PERFORMANCE JACKET.

TECHNICAL CHARACTERISTICS

DIAMETER		WEIGHT	WORKING PRESSURE	TESTING PRESSURE	BREAKAGE PRESSURE
Inches	mm.	gr/m	Bars	Bars	Bars
1"	25	240	50	100	>150
1-1/2"	38	350	33	67	>100
1-3/4"	45	390	33	67	>100
2"	50	450	30	60	>90
2-1/2"	64	640	27	54	>80
3"	75	750	21	43	>65

**DESIGNATION HOSE**

Tel: +27 11 791 6730

Email: chase@designationhose.com

# DESIGNATION HOSE



**NOZZLES**  
Handline Nozzles  
Specialty Nozzles  
Monitor Nozzles  
Foam Equipment



**MONITORS**  
Industrial Ground Monitors  
Portable Ground Monitors  
Dual-Purpose Ground Monitors  
Remote Control Monitors  
Wireless Remote Control Monitors



**FIRE FIGHTING EQUIPMENT**  
Tools  
Safety equipment  
Foam Bags

## STYLE 366

## Unique Features On Protek Nozzles



## Technical Data

Style	Nozzle Pressure		Flow Settings		Actual Flow		Straight Stream Reach			
	PSI	BAR	GPM	LPM	GPM	LPM	Effective		Overall	
							Feet	Meters	Feet	Meters
366	75	5	30	115	26	98	67	20	90	27
			60	230	52	197	85	26	110	34
			90	360	82	310	99	30	130	39
			125	475	108	409	106	32	140	42
	100	7	30	115	30	115	78	24	95	29
			60	230	60	230	94	28	115	35
			90	360	90	360	109	33	135	41
			125	475	125	475	122	37	150	45
	125	8,5	30	115	34	129	81	25	100	30
			60	230	67	254	99	30	120	36
			90	360	107	401	115	35	135	41
			125	475	140	530	133	40	145	44



Industrial Ground Monitors    Portable Ground Monitors    Dual-Purpose Ground Monitors    Portable Oscillating Ground Monitors    Remote Control Monitors    Wireless Remote Control Monitors



Selectable Gallonage Nozzles    EN15182-2 Type 3 Compliant Nozzles    Multi-Purpose Nozzles    Automatic Nozzles    Constant Gallonage Nozzles    High Pressure Nozzles    Shockless Nozzles



Self-Educating Handline Nozzles    Dual-Flow Foam Nozzles

Chase Remington  
Director

Tel: +27 11 791 6730  
16 End Extension street



**INDUSTRIAL HOSES**

Compressed air, water pump, hydraulics, mining hoses and other



**FIRE FIGHTING HOSES**

Fire fighting, forestry, high-rises and cabinet hoses



**FIRE FIGHTING EQUIPMENT**

Nozzles, Monitors and other fire fighting equipment



**CUSTOM MADE HOISING**

Custom-made hosing to suit clients needs

# DESIGNATION HOSE

Mobile +27 63 773 3221

Email: chase@designationhose.com

City and Suburban

Johannesburg

# DESIGNATION HOSE

16 End Extension Street  
City and Suburban

+27 11 791 6730

chase@designationhose.com



**Dr. STHAMER HAMBURG**



A business of  
**AECI**  
good chemistry

**ChemSystems, a division of AECI  
has a good history  
of fighting fires in South Africa**

# FOAM FIGHTS FIRE

- C/S RLF 4 for Class A Fires
- C/S Super HI-EX for Class A&B Class fires as well as foam parties
- Flame-Bloc as wetting agents
- Airmaster for aerial bombing
- Fire Retardants
- Local technical laboratories
- Local manufacture
- ChemSystems manufactures all Dr. STHAMER Hamburg products under license in South Africa
- STHAMEX AFFF 1%, 3% & 6% for hydrocarbon fires
- STHAMEX MOUSSOL APS for alcohol fires in 1/3, 3/3 and 3/6 economy or premium grades with 1A/1A approvals
- New environmentally friendly Fluorine Free range.

Contact : André Schütte - Coastal  
+27 83 252 1411  
andre.schutte@chemsystems.co.za

Mason Naidoo - Gauteng  
+27 79 514 6907  
mason.naidoo@chemsystems.co.za

[www.chemsystems.co.za](http://www.chemsystems.co.za)

All products carry EN1568 approvals  
ISO 9001 & ISO 14001  
OHSAS 18001  
Responsible Care Certificate



# Vs FOCUM

## FIRE FIGHTING FOAM CONCENTRATES



**‘The usual’ may not be the ideal solution anymore**

Since its foundation in 2002, Vs Focum has directed all its efforts into one simple goal: **We believe in improving safety.**

To get to the next level of safety, we take in sight:

- 1) the firefighters own risk
- 2) the impact of foam solutions on Nature
- 3) the need of solving a dangerous scenario as soon as possible

We work this way to achieve getting the most out of mobile and stationary systems. We happen to accomplish these because we consider that **regular products do not match up our goal.**

**We deal directly with the problem to get the best solution.**

Some of the breakthrough additions to the VsFocum catalogue:

- **ATILA:** AFFF-AR - 1% ICAO-C
- **SILVARA ZFK (0.5%) / SILVARA 1 (1%)** Newtonian FFF
- **TwinGelFoam:** gelled foam at 1%
- **BoldFoam APC:** All Purpose Concentrate - FFF/AR 3x6
- **BoldFoam F40:** 100% ‘ready to use’ solution for oil fires, hydrocarbons, polar solvents, solids for extinguishers, CAFS, etc.

**FREMTAC**  
FIRE AND RESCUE CC

**JIMMY CROUCAMP**

Mobile: +2782 412 6319  
Fax: +2786 656 9427  
Email: jimmy.c@fremtac.com  
[www.fremtac.com](http://www.fremtac.com)

# A Protective Foam Blanket in Less than 60 Seconds...



## PRO/pak®

- Class A, AFFF & AR-AFFF
- 9.5L Foam Reservoir
- 3 bar to 34 bar Operation
- 0.1% to 6% Injection Ratios
- Low or Medium Expansion Finished Foam



Spill Control



Extrication



Pretreatment

## Medium-Expansion Foam Nozzle



230, 360, or 475 l/min

These simple, lightweight, durable foam nozzles deliver the same thick, long lasting foam blanket, which has come to be expected of TFT foam products, without the need for a separate nozzle. Compact and easy to maintain, these nozzles deliver consistent foam aspiration, and are engineered to provide optimum foam production, when paired with a matching TFT educator. A TFT F140 inline ball valve can be ordered separately to provide shutoff capability.

## Foam Educator



230, 360, or 475 l/min

## QuadraCup Foam Nozzle



Selectable Liter Nozzle  
Straight Stream  
to Wide Fog

Slide Forward for  
Foam Aspiration  
Retract Instantly  
for Rapid Wide Fog

## FOAM When You Want It, PROTECTION When You Need It

- 30, 230, 360 or 475 l/min @ 7 bar
- Retractable foam aspirating sleeve
- Rotate from straight stream to wide fog
- Adjustable pattern for reach and aspiration

[www.facebook.com/vanguardfs](https://www.facebook.com/vanguardfs)  
[www.twitter.com/@vanguardfs](https://www.twitter.com/@vanguardfs)

**TASK FORCE TIPS®**  
FIRE FIGHTING EQUIPMENT



TFT.com



[info@vanguardafrica.co.za](mailto:info@vanguardafrica.co.za)  
[www.vanguardfire.co.za](http://www.vanguardfire.co.za)  
Durban: +27 (0)31 564 3200  
Port Elizabeth: +27 (0)41 451 2461

# Marcé Fire Fighting Gas Detection Monitors



## E6000 Multi Gas Detector

### Multi Detection

Detects up to 7 kinds of gases simultaneously

### Application

It's functional and watertight design (IP 66) incorporates a bump proof, rubberised housing to meet the toughest requirements of harsh environments

## BX 616 Multi Gas Detector

### Multi Detection

Can detect combustible gas, O2 and two other kinds of toxic gasses simultaneously

### Application

It is widely used in the area where intrinsically safe units are required, like underground channels or mining industry, so as to protect users lives and avoid damage to relevant equipment



## BX172 Single Gas Detector



### Gas Detection

Personal Portable gas detector, intrinsically safe design can continuously monitor the gas concentration in the environment

### Application

Widely used in industries like city gas, petrolchemical, fire & safety, vessel industry, oil warehouse, oil station, etc.



**"Products that SAVE lives"**

[www.marce.co.za](http://www.marce.co.za) | [sales@marce.co.za](mailto:sales@marce.co.za)





  
**Tyvek.** **Tychem.**

FOR GREATER GOOD™

## PROTECTIVE GARMENTS FOR EMERGENCY RESPONDERS

Assistance in the selection of appropriate protective garments for the chemical, biological and other hazards that emergency responders may face in their duties.

More information: [www.safespec.dupont.co.uk](http://www.safespec.dupont.co.uk)

For further information contact

Loren Pearson Cell: +27 (0)82 377 6765 Tel: +27 (0) 11 218 8654

Email: [loren.pearson@dupont.com](mailto:loren.pearson@dupont.com)

[www.Safespec.dupont.co.uk](http://www.Safespec.dupont.co.uk)

38

The DuPont logo, DuPont and Tyvek® are registered trademarks or trademarks of DuPont or its affiliates

# Your Mission drives us

Protecting you while you protect others.

At Dräger, we believe that safety technology should make it possible for you to do your job more quickly, safely, and effectively.



**Firefighting Helmet  
HPS® 7000**

Tailor-made fit for every head. Two helmet shells cover a wide range of individual head and face shapes. It's one of the lightest helmets in its class.



**Full-Face Mask with integrated  
Communication System:  
FPS®-Com 7000**

Hands-free communication for all wearers of respiratory protection devices during a mission with full-duplex communication –as if you were on the phone.



**Personal Alert Safety System  
Dräger Bodyguard® 1000**

Designed to protect life by alerting the team when a wearer becomes motionless or distressed.



**Fire Escape Hood  
Parat® 5550**

Specifically developed for fire rescue teams for use in victim rescue, the PARAT® 5550 is system approved together with Dräger breathing apparatus according to EN 137:2006, Type 2.

For more information visit: [draeger.com](http://draeger.com)



## UST TRADITIONAL SERIES STRUCTURAL FIRE HELMET

### Tough and durable

Bullard UST Series Fire Helmets are engineered Tough™ for extreme conditions. The outer shell is made of Thermoglas and is more resistant to chemical attack and more stable at extreme temperatures. The dual-purpose CFC-free urethane foam of the impact liner provides superior impact and penetration protection.

### Custom Copy

Equipped with the U-Fit system offering 12 custom comfort settings. 12 points of adjustment allow the ride and balance of the helmet to be adjusted.

### Premium Quality

The front is adorned with an intricately carved genuine brass eagle leather front holder. For maximum visibility, UST helmets come standard with high quality Scotchlite striping. The Bullard Sure Lock® ratchet headband offers easy turn sizing and unique three position height adjuster.

### Bullard Bourke Eyeshields

Bullard Bourke eyeshields are available in NFPA compliant versions.



## Firedome® LTX LIGHTWEIGHT STRUCTURAL FIRE HELMET

### Tough and Durable

The outer shell of the LT is made of the same high-heat Ultem® thermoplastic engineered in Bullard PX™ structural fire helmets.

### Quick, Easy Sizing

The Bullard Sure-Lock® ratchet headband offers both a quick-turn of the knob and a new, unique 3-position height adjuster to create that personalised fit.

### Eye Protection Made Easy

Bullard LT Series helmets come standard with all the new and innovative Quick-Attach Blade™ system which permits the firefighter to simply press on or off either a blade-mounted faceshield or blade-mounted goggle in seconds.

### Cost-Effective Maintenance

LT helmets are designed from the start to make maintenance simple and cost effective with fewer components.

### NFPA Approved

UST and LT fire helmets exceed the NFPA 1971 Standard on Protective Ensemble for Structural Fire Fighting 2013 edition pertaining to Structural Fire Helmets

info@vanguardafrica.co.za  
www.vanguardfire.co.za

Durban: +27 (0)31 564 3200  
Port Elizabeth: +27 (0)41 451 2461



Like us on Facebook: facebook.com/Vanguardfs  
Follow us on Twitter: twitter.com/@vanguardfs



# Marcé Fire Fighting FIRE FIGHTING HOSES

### Diameter

38mm, 45mm, 65mm, 100mm

### Resistance

Better oil resistance, Abrasion resistant  
Long service life.

### Pressure

Working Pressure: 16 Bar  
Testing Pressure: 32 Bar  
Bursting Pressure: 48 Bar



### Couplings

British Instantaneous,  
Stortz or NST

## Marcé Rubber Hose

Double Rubber Hose.  
Designed especially for Fire Fighting, Chemical Spillage, wash down, water transfer. Marine mining, oil field and construction. Outer Colour : Black, Red or Blue. High Strength polyester filament woven jacket.



Scan me

### Safety Factor

Includes a second closely woven jacket outside for extra durability

## Marcé Double Jacket Hose

Double Jacket Fire Hose.  
Designed especially for hard conditions & high-pressure requirements. Jacket Colour : White. No need to dry after use.

### Design

For hard conditions and high-pressure requirements



"Products that SAVE lives"

www.marce.co.za | sales@marce.co.za



**POLYDUR**

**BS 6391 TYPE 3 FIRE HOSE**

Supreme heavy duty lay flat hose for all fire fighting operations. Circular woven jacket out of 100% high tenacity synthetic yarn embedded in a vulcanized high grain Nitrile/PVC compound using the "Through-the-weave-extrusion process". Offers high resistance to acids, salt solutions, oil, fuel and many more chemicals.

**ADVANTAGES**

- Lightweight lay flat hose
- Minimum friction loss
- High aging resistance
- Ribs on outside lining for high abrasion resistance
- High resistance to oil, chemicals and fuel
- Excellent resistance to ozone and weathering
- Cold-resistant down to -35°C
- Heat-resistant up to +100°C
- Easy maintenance and handling
- Easy to repair

**SERVICE**

- Standard colour red, other colours on request
- Light ribless version available
- Individual marking available
- Binding with international couplings available on request
- Other diameters on request
- Available in lengths up to 120 m

**APPROVALS**

- DIN 14811:2008-01 Class 3
- BS 6391:1983 Type III
- MED 96/98/EC SBG
- Russian Maritime Register

**ADVANTAGES**

- Lightweight lay flat hose
- Minimum friction loss
- High aging resistance
- Ribs on outside lining for high abrasion resistance
- High resistance to oil, chemicals and fuel
- Excellent resistance to ozone and weathering
- Cold-resistant up to -35°C
- Heat-resistant up to +100°C
- Easy maintenance and handling

**SYNTHETIC DRAGON**

Fire hose **MADE FOR HELL**



info@vanguardafrica.co.za  
www.vanguardfire.co.za

Durban: +27 (0)31 564 3200  
Port Elizabeth: +27 (0)41 451 2461



**STOPPING THE SPREAD OF TAKE-HOME TOXINS**



Tyvek 500® Xpert offers superior Type 5 particulate protection

- Asbestos
- Fiberglass
- Lead
- Radioactive particles
- Pesticides

**FOR GREATER GOOD™**



For further information contact  
Loren Pearson Cell: +27 (0)82 377 6765  
Tel: +27 (0) 11 218 8654  
Email: loren.pearson@dupont.com  
www.Safespec.dupont.co.uk

# PowerFlow

12/10 17/10

*Big on performance  
small in size*

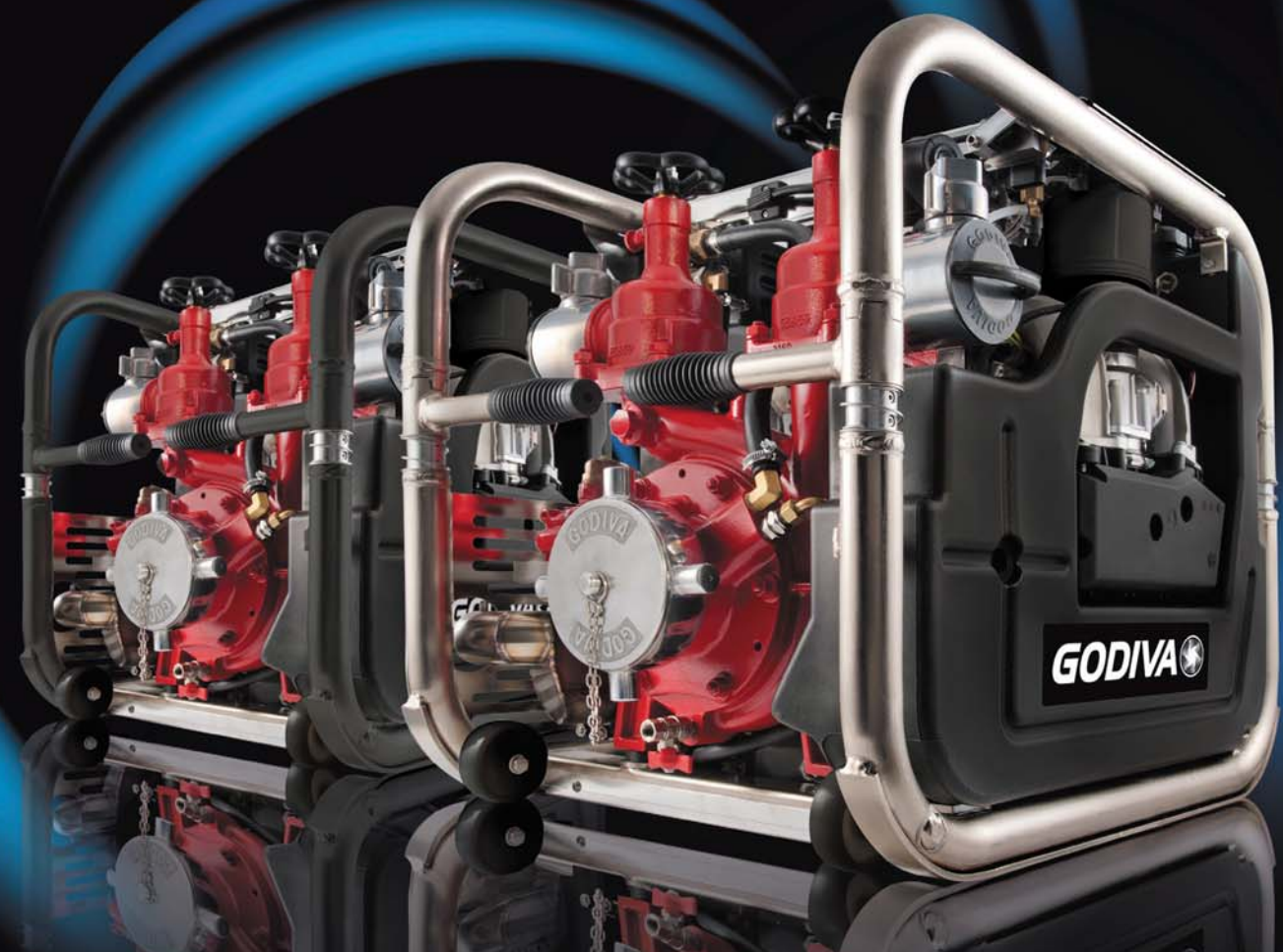

When a powerful performance is required yet space is at a premium, the **Godiva Powerflow 12/10** and **17/10** is what you need.

With an unrivalled power to weight ratio, experience first-hand how a portable big on performance and small in size can add real value.

For more information contact:  
Daniel Janse van Rensburg, Regional Manager - Africa

South African Mobile: +27 (0) 83 263 1796  
Email: [godiva.africa@idexcorp.com](mailto:godiva.africa@idexcorp.com)  
Skype: danielvr50

[www.godiva.co.uk](http://www.godiva.co.uk)  
[www.haleproducts.com](http://www.haleproducts.com)



## PORTABLE PUMPS

### GODIVA POWERFLOW GP8/5 PORTABLE PUMP



- Extended service duty: 800 lpm (200gpm) @ 5 bar (70 psi)
- Maximum pressure: 8 bar (120 psi)
- Maximum flowrate: 1400lpm (360gpm) 62 kg
- Stainless steel wrap-around protection frame
- Integrated fuel tank inside frame (1:30mins running at 800lpm@5 bars )
- Control panel ( electric start, primer control, 2 x gauges, hour meter, choke supplied as standard)
- Light Alloy Aluminium pump body
- Flood recovery/ Disaster management – 1400 lpm (360gpm) at 3 bars
- Ultra Compact design - 555mm x 490 mm x 584mm
- 3 metre priming with 4 inch suction hose – 30 seconds.



### HALE POWER FLOW HPX/HPT75 / YD9



- High Pressure diesel driven portable pump
- 400lpm (100gpm) flowrate
- 14.5 bar (200psi) pressure
- Extended service at:
  - 200lpm (53 GPM) @ 10 bar (150psi)
- 9hp Yanmar Marine Diesel Engine
  - Diesel Fuel safety
  - Low Maintenance
  - Long life
- Available in vehicle mounted (HPX) or Portable (HPT) configuration
- 12 volt electric start with pull start back up
- 67 kg (147 lbs)
- 558mm x 457mm x 558mm
- Fully enclosed Balanced Bronze impellor fitted as standard
- Direct drive step up gearbox reliability
- Full pump control panel supplied as standard.



### GODIVA POWER FLOW GP17/10



- Most compact, High Performance Portable pump range on the market
  - GP17/10
    - 1700lpm (550gpm) @10 bar (150psi)
    - 128 kg - 677mm x 525mm x 620mm
  - GP12/10
    - 1200 lpm (320gpm) @10 bar ( 150psi)
    - 125 kg - 677mm x 525mm x 620mm
- Fully Integrated control panel supplied with pump
- 1 hour 30 minute fuel tank integrated in frame (option for remote fuel tank available)
- Wheel Barrow wheel option available for easy manoeuvring (extendable carry handles supplied as standard)
- 2 cylinder 4 stroke Petrol engine
- Choice of fire hose connections available.



Daniel Janse van Rensburg - Regional Manager - Africa  
South African Mobile: +27 (0) 83 263 1796  
Email: [godiva.africa@idexcorp.com](mailto:godiva.africa@idexcorp.com) / Skype: danielvr50  
Website: [www.godiva.co.uk](http://www.godiva.co.uk) / Website: [www.haleproducts.com](http://www.haleproducts.com)





# When size matters

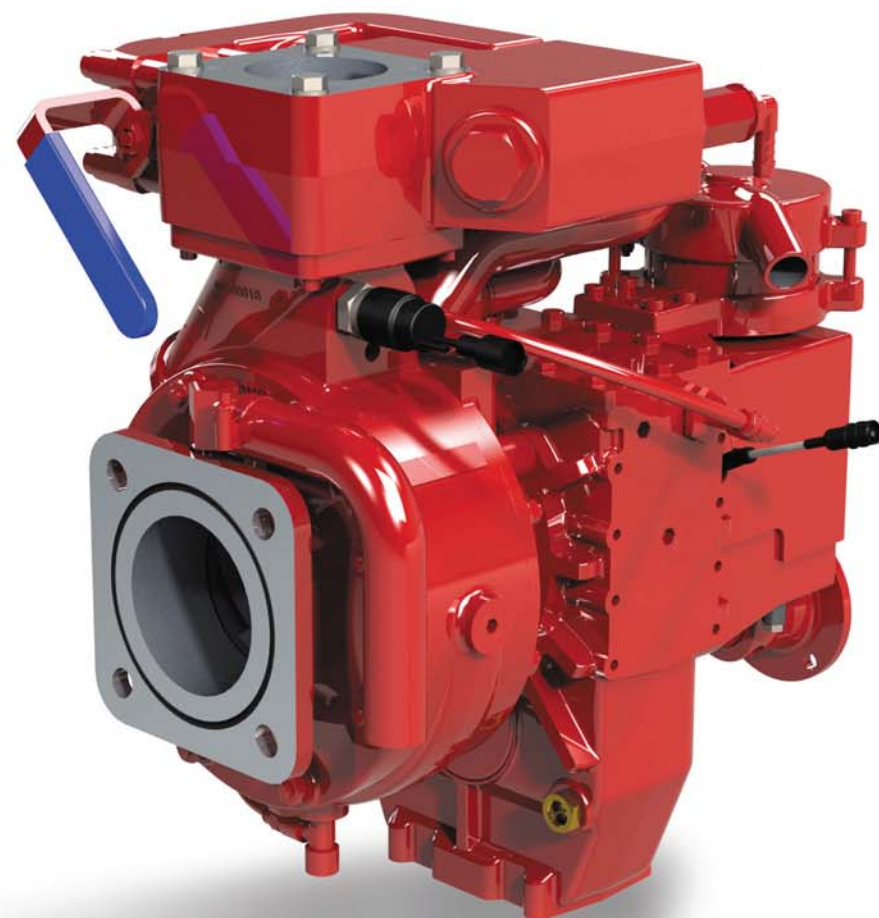

The Godiva KP range of pumps is big on performance and small in size. Built for today's compact vehicle designs the KP is available as a single pressure pump that is 40% smaller and 30% lighter and a multi-pressure pump that is 30% smaller and 29% lighter than the competition.

Reduced whole life cost of ownership is achieved with 5 year oil change interval for the gearbox, a dry running single piston primer with safety interlock, and the use of a mechanical seal.

**EN1028 Rated**

Normal pressure performance to EN1028 rated 1500 LPM @ 10 bar  
High pressure pump performance to EN1028 rated 250 LPM @ 40 bar

**For more information contact:** Daniel Janse van Rensburg, Regional Manager - Africa  
**South African Mobile:** +27 (0) 83 263 1796  
**Email:** godiva.africa@idexcorp.com  
**Skype:** danielvr50

www.godiva.co.uk  
www.haleproducts.com

## VEHICLE MOUNTED PUMPS

### GODIVA KP PUMP



- Designed to give the Small Fire Vehicle option the Twin pressure advantage
- 30% smaller and lighter than equivalent competition pumps (Complete twin pressure pump - 76kg)
  - *Single Pressure:*  
1500 lpm (400gpm) @ 10bar (150 psi)
  - *Twin Pressure:*  
1500lpm (400gpm) @ 10 Bar (150 psi)  
250lpm (70gpm)@ 40 Bar (600 psi)
- Integrated Automatic Primer as standard
- Integrated gearbox as standard to suit most PTO ratios
- Designed for easy installation and easy maintenance
- Designed to reduce whole life cost:
  - Automatic Piston Primer – No forced maintenance
  - 5 year Pump maintenance schedule
  - Repair parts available in kit form

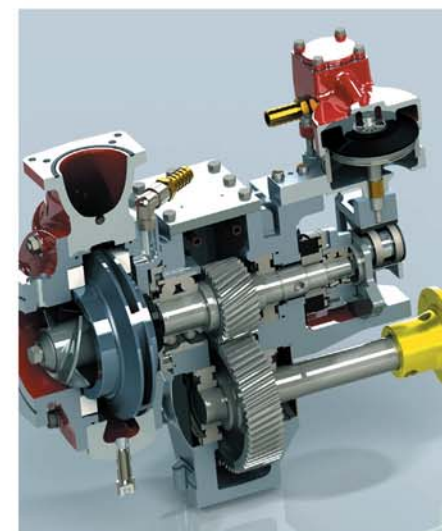

### PRIMA SINGLE AND TWIN PRESSURE PUMP



- 2000lpm (500gpm) 3000lpm (790gpm) 4000lpm (1050gpm) 6000lpm (1500gpm) units available in Single and Twin pressure
- Most compact Fire Pump in its Class
- Integration and modular design enable the pump to be manufactured exactly to your brigade's requirements.
- Designed to the latest Fire Fighting Centrifugal Pump with Primer EN1028:1 Standards
- NFPA approved
- Performance:**
  - 17 Bar (250 psi) Low pressure
  - 55 Bar (790 psi) High Pressure
  - Simultaneous operation
- Made From Marine Grade LM25 Lightweight Aluminium Alloy
- Integrated Proportional RTP Foam System
- Integrated Collecting Head.



### GODIVA PRIMA SMART CAFS



- Compressed Air Foam System integrated around our well known Godiva Prima Twin Pressure Pump
- Pump, Compressor and Foam pump integrated into one PTO driven package
- Push Button operation – Pre-set can be user adjusted to suit the type of CAFS fire suppression required
- Small, Medium and Large Flow rate systems available to suit local risks
- Ability to use Class A or Class B foam
- User Defined Wet and Dry Foam available
  - push button simplicity
- Godiva Smart CAFS Advantages
  - Proven Improved fire knock down over water
  - Reduced water damage
  - Reduced water run off
  - Less foam used – Financial and environmental advantages
  - Lighter hose lengths for easier manoeuvring
  - Less frictional loss.



# CHARGE TO THE RESCUE

**ion™**  
Battery Powered Tools  
From AMKUS Rescue  
Systems

iC550 Cutter

- Rugged all metal body with rotating lighted handle
- Powerful yet compact for use in tight space operations
- Safe and balanced tool for rapid deployment and ease of use

iS240 (24") or iS280 (28")  
Spreaders

iCT516 Combi-Tool

iTR230 Ram

**AMKUS®**  
RESCUE SYSTEMS

**VANGUARD**  
FIRE & SAFETY

info@vanguardafrica.co.za www.vanguardfire.co.za  
Durban: +27 (0)31 564 3200  
Port Elizabeth: +27 (0)41 451 2461

AMKUS.COM     



**E8FC320<sub>D</sub>**



CAN BE OPERATED WITH 1 OR 2 BATTERIES!

**STORM**  
SERIES  
**2**



TECHNICAL SPECS	STANDARD	METRIC
LENGTH	34.6 IN	878.8 MM
HEIGHT	7.0 IN	177.8 MM
WIDTH	10.75 IN	273.1 MM
WEIGHT		
NO BATTERIES	58.5 LBS	26.5 KG
ONE BATTERY	60.8 LBS	27.6 KG
TWO BATTERIES	63.1 LBS	28.6 KG
MAX. BLADE OPENING	9.12 IN	231.6 MM
MAX. CUT LENGTH	6.38 IN	162.1 MM
MAX. CUT FORCE	320,000 LBS	1,423.4 KN
POWER SOURCE	28 VOLT MILWAUKEE BATTERY	
MFG. TO NFPA 1936-2015	YES	
NFPA CUT TEST	A9, B9, C9, D9, E9	



Scan me

PRODUCTS THAT  
SAVE LIVES



Marcé Fire Fighting Technology (PTY) LTD  
1012 Ergon Road, Lyttelton Manor  
Gauteng, Centurion  
South Africa  
www.marce.co.za

\* EVERY COMPONENT IN THE STORM SERIES IS COVERED BY THE TNT FOREVER WARRANTY, EXCEPT THE BATTERIES AND BATTERY CHARGER WHICH HAVE A THREE-YEAR WARRANTY.





# Marcé Fire Fighting

## Rescue Equipment



**FIREBREAK SA**  
SAFETY APPLIANCES PTY LTD

A LEVEL 1 CERTIFIED BBBEE CONTRIBUTOR

EVERYTHING YOU NEED  
**FOR RESCUE!**

**PARATECH**

Tel: +27 11 908 6960 Fax: +27 11 908 6961

[www.firebreaksa.co.za](http://www.firebreaksa.co.za)



*"Excellence through innovation"*

Sole supplier of Paratech Equipment [www.marce.co.za](http://www.marce.co.za) | [sales@marce.co.za](mailto:sales@marce.co.za)



# LUKAS

**S 799 E 2 / S 799**

**MORE SPEED**

Fastest rescue through one-cut operation in any cutting position

**BLADE GEOMETRY**

More force at the right point through perfect pulling effect

**MORE POWER**

NFPA: ALL 9, EN: ALL K



Hamilton Hydraulic Services

Route 24, Unit 26, Fleming Road, Meadowdale, Edenvale, South Africa

Office: + 27 (11) 8281083, Cell: + 27 82 893 1883 Email: hhshurst@netactive.co.za

 /LUKAS.Rescue · [www.lukas.com](http://www.lukas.com)

# NEW! EVO 3 CORDLESS RESCUE TOOLS

Our next generation battery-powered rescue tools deliver unmatched performance at a higher speed. Especially when it really counts, during challenging extrications. Combined with a clever design optimizing the benefits of cordless, these tools offer you ultimate freedom.



## The Rescue Tool Guys

Unit 18, Saligna Park 3 Saligna Road  
Witfield 1459  
T +27-82 609 3438  
E johan@trtg.co.za



WWW.TRTG.CO.ZA

**INLINE CONTROL  
HANDLE WITH  
360° ACCES**

**SMART  
BATTERY  
POSITION**

**MORE  
WORKING  
SPACE**

**INCLINED CUTTING**

## ULTIMATE FREEDOM

### Inline control handle with 360° acces

Centrally placed at the back of the tool, our control handle is always within reach, even in the most difficult positions and at all sides of the car.

### Smart battery position

The battery on top of the tool is always accessible and easy to change, even when space is limited.

### More working space

Also available in a cordless version is our unique Inclined Cutter, offering improved ergonomics and maximized working space. Designed for easy use at all sides of the car.

**WATCH THE VIDEO OR  
REQUEST A DEMO ON  
HOLMATRO.COM/EV03**

# THE FUTURE IS CORDLESS

**1<sup>ST</sup> CHOICE**  
FOR OVER 50 YRS

WORLD'S LEADING RESCUE TOOLS



## NEW! EVO 3 UNMATCHED PERFORMANCE ULTIMATE FREEDOM

The next generation EVO 3 battery rescue tools deliver unmatched performance at a higher speed. Thanks to their smart design optimizing the benefits of cordless, these tools offer you ultimate freedom.

Go to [www.holmatro.com/evo3](http://www.holmatro.com/evo3)

### The Rescue Tool Guys

Unit 18, Saligna Park 3 Saligna Road  
Witfield 1459  
T +27-82 609 3438  
E [johan@trtg.co.za](mailto:johan@trtg.co.za)



[WWW.TR TG.CO.ZA](http://WWW.TR TG.CO.ZA)

**holmatro**  
mastering power

# LIFTING BAGS

High Pressure Series

**1<sup>ST</sup> CHOICE**  
FOR OVER 50 YRS

WORLD'S LEADING RESCUE TOOLS

## MAXIMUM SAFETY AND CONTROL

At 50% More Lifting Power

The new Holmatro 12 bar lifting bags offer a 50% higher performance. They come with a completely redesigned control unit, allowing you to apply this increased power in a safe and controlled way. Now with many user-friendly features!

More information on  
[www.holmatro.com](http://www.holmatro.com)



### The Rescue Tool Guys

Unit 18, Saligna Park 3 Saligna Road  
Witfield 1459  
T +27-82 609 3438  
E [johan@trtg.co.za](mailto:johan@trtg.co.za)



[WWW.TR TG.CO.ZA](http://WWW.TR TG.CO.ZA)

**holmatro**  
mastering power

**1<sup>ST</sup> CHOICE**  
 FOR OVER 50 YRS

WORLD'S LEADING  
 RESCUE  
 TOOLS



**World-class hydraulic rescue equipment**  
**Excellent after sales service**



When it comes to the crunch,  
 you can rely on  
**HOLMATRO CUTTERS**



**Sales Director**  
 Johan Muller  
 + 27 82 609 3438  
 + 27 11 823 2481  
 johan@trtg.co.za

**Service Director**  
 Romeo Letageng  
 + 27 79 880 5251  
 + 27 11 823 1927  
 romeo@trtg.co.za

**Maximum Safety & Control**  
 at 50% more lifting power  
**HIGH PRESSURE LIFTING BAGS**



**THE FUTURE IS CORDLESS**  
 Unmatched performance.  
 Ultimate freedom.  
**NEW! EVO 3**



[www.holmatro.com](http://www.holmatro.com)

# Marcé Fire Fighting

## Rope Rescue



### RESCUE CACHE PRO

Designed for the professional rope rescuer—contains all the components for a basic high angle rescue system



### RESCUE CACHE AUTOLOCK PRO

Designed for the most up-to-date twin-tensioned rope rescue techniques



### ANEXK9 HARNESS

Available in small, medium and large  
Vertical lift harness, designed to securely raise or lower your working dog



### CASCADE TERRA TAMER TRANSPORT WHEEL

26 x 4.75" all-terrain wheel  
The Terra Tamer is an exceptionally light, obstacle crushing wheel that fits on any litter using a rapid attachment system



### HAULERBINER COMPACT RESCUE SYSTEM

This compact kit can be worn on the harness and used for pick-offs in work at height and rope access rescues

### VECTOR

3 lbs 1 oz, 47.73 inches  
This monopod has been designed and engineered as a light-weight, portable tool for use in industrial, mountain and urban rescue environments



## MOBILITY MOBILE DATA TERMINALS

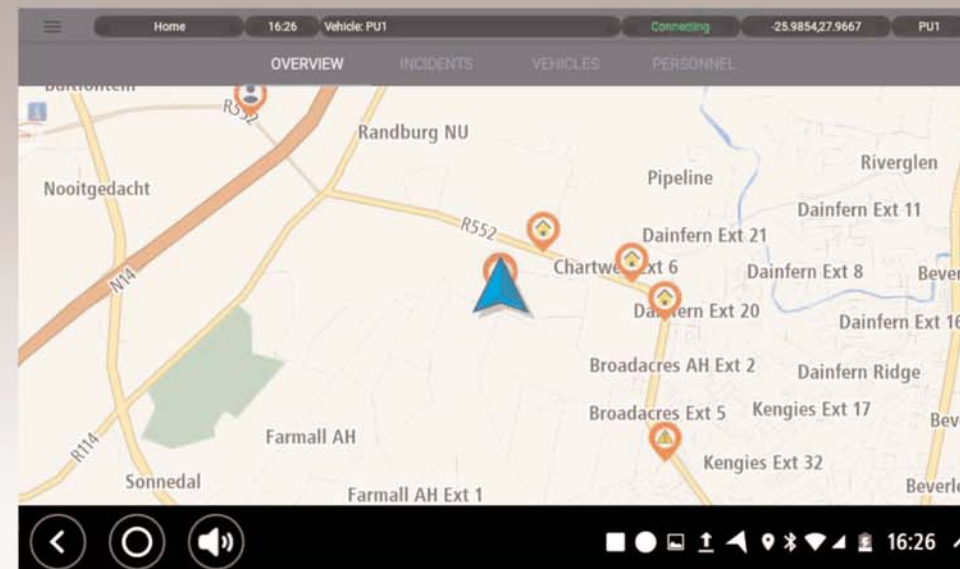

### FEATURES

- Automatic On-Board Voice Guided Navigation, Vehicle Tracking and Status Updates
- Track, Manage and Control Resources on the Fly
- Real-time Despatch and Feedback of Data and Voice Communications
- Supports Multiple Network Technologies simultaneously on Multiple Hardware Devices
- Companion App** for crew members, streaming video, pictures, data capture etc
- Fully Integrated with ESS Call Taking, Despatching and Resource Management Software



Tel: 0861 SYSMAN

email: info@sysman.co.za website: www.sysman.co.za

"Products that SAVE lives"

www.marce.co.za | sales@marce.co.za





## DISASTER & INCIDENT MANAGEMENT SOLUTION



### DISASTER & INCIDENT MANAGEMENT

- Unified Command System
- Improves Role Player Co-ordination, Response & Information Sharing
- Enables Response Agencies to plan for Events/Incidents/Disasters
- Enables a Quick Response to Unplanned Crises
- Integrated Document Management and Mass Communication
- A variety of apps for Mobile Devices including Video Streaming from Incidents



▪ **Tel 0861 SYSMAN**  
email: info@sysman.co.za website: www.sysman.co.za

## UNIFIED COMMUNICATIONS

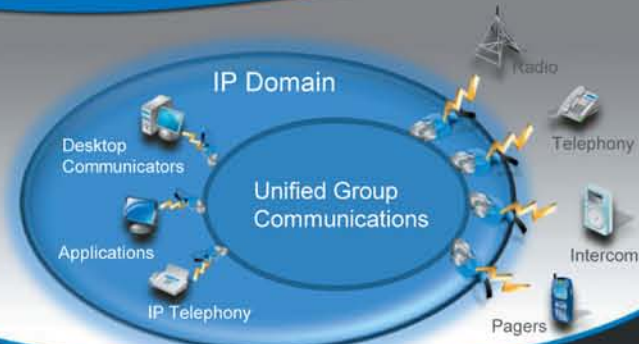

### FEATURES

- Simplification and integration of all forms of communications
- Users can interact irrespective of the technology in use
- Radio systems of all types can operate seamlessly together regardless of make, model and frequency
- Analogue, IP and cellular telephones can be patched into a radio network and used as push-to-talk devices
- Brings all communications under a single, unifying umbrella where disparate technologies, user type and location are no longer a limiting factor



▪ **Tel 0861 SYSMAN**  
email: info@sysman.co.za website: www.sysman.co.za

## RADIO INTEROPERABILITY



### FEATURES

- Communications over an IP Network, enabling Interoperable communications between any Connected Devices
- Works with your Current Radio System
- Connects with any Radio Equipment from any Manufacturer at any Frequency
- Shared Communications systems that deliver a Mission-Critical Communications Capability and that spans every Communications Medium
- Communications interoperability using IP Network-based solutions provide the greatest value and the most effective Interoperability solution available today



▪ **Tel 0861 SYSMAN**  
email: info@sysman.co.za website: www.sysman.co.za

## ALL NEW REMRAD



### FEATURES

- Linking Premises to up to FOUR different Emergency Services
- Fully integrates with ESS (or can be standalone)
- Cloud based with automatic network switching
- 7" or 10" touch screen systems (model dependent)
- Two-way voice communication between Control Centres and the unit
- 24/7 Monitoring of protected premises
- Launch Date: Quarter 1, 2019
- Over 1, 300 previous-model installations nationwide



▪ **Tel 0861 SYSMAN**  
email: info@sysman.co.za website: www.sysman.co.za

## EMERGENCY SERVICES SYSTEM



### FEATURES

- Call Taking, Despatch & Resource Management System
- Integrated Mobile Data Terminals/Mapping/GIS Capabilities
- Automated Station Control, Paging/Messaging
- Automated and Customisable Checklists & Procedures
- Real-time Wallboard Display



▪ **Tel: 0861 SYSMAN**  
email: info@sysman.co.za website: www.sysman.co.za

## iFIG Multi System Control Solution



### FEATURES

- Radio over IP - Access your Radio's from anywhere on your WAN
- Intercom & PA - Full PA system with Individual Point Calling/Call Back (Intercom)
- Station Controls - Soft Control Bells, Bay Doors, Gates, Booms, Robots, Doors, Lights, Sirens and Other 3<sup>rd</sup> Party Systems
- Ease of Setup - Quick Configuration of Parameterised Software



▪ **Tel: 0861 SYSMAN**  
email: info@sysman.co.za website: www.sysman.co.za

## SCM Service Call Management



### FEATURES

- Despatch Service Personnel carrying Mobile Tablet Devices
- Schedule Service Calls using Least Cost Routing
- Navigate Service Personnel to Service Call Locations
- Streaming Video, Pictures and VOIP Calling back to control centre
- Customisable Software to handle any type of Service Call
- Monitor location and Service Personnel Performance
- Immediate Updates on Completed Calls
- Examples include: Hydrant , Vehicle, Equipment maintenance etc



▪ **Tel 0861 SYSMAN**  
email: info@sysman.co.za website: www.sysman.co.za

## DoTellUs Citizen's App



### Get help when you need it

- Send Emergency Alarms with your location:
  - to up to FOUR different Emergency Services
- Send complaints to Municipal Departments. For example:
  - Power outages, water leaks, robots not working, potholes etc
  - Optionally add picture
- Notify loved ones when an emergency alarm is activated



▪ **Tel 0861 SYSMAN**  
email: info@sysman.co.za website: www.sysman.co.za

# Marcé Fire Fighting

## AMS & Computer Aided Dispatch



### Asset Management

- ✓ Asset Management Module
- ✓ Vehicle Management Module
- ✓ SCBA Tracking Module
- ✓ Mobile Tracking
- ✓ Asset Verification
- ✓ Track Back plates
- ✓ Track SCBA Masks
- ✓ Track Cylinders
- ✓ Track PASS Units

Marcé Asset Management is an asset management system which manages asset across departments, locations, facilities, and in some case department units. By managing assets across facilities, departments can improve utilization and performance, reduce capital costs, asset related operating costs and extend asset life and subsequently improve ROA (return on asset).

To book a demo please contact Marcé on +27 12 742 9200 or email [sales@marce.co.za](mailto:sales@marce.co.za)

### Computer Aided Dispatch

- ✓ Incident Information
- ✓ Information Files
- ✓ Unit Display
- ✓ Incident Action Interface
- ✓ Patient Information
- ✓ Live Mapping
- ✓ Mobile CAD
- ✓ Location Verification
- ✓ Incident Display
- ✓ Incident Dispatch
- ✓ Time Stamping
- ✓ Report Generation
- ✓ Maintenance & Security

Marcé CAD Software is a fully functional CAD system that includes such options as vehicle tracking, automatic e-mail notifications and more.

Our CAD software extends to a mobile platform which allows for tracking of units in service and incident information display for fire fighters responding or on scene. Live incident overview available on your smart device.

*"Products that SAVE lives"*

[www.marce.co.za](http://www.marce.co.za) | [sales@marce.co.za](mailto:sales@marce.co.za)



### DISASTER MANAGEMENT

- First on Scene
- Incident Command
- Technical Search and rescue
- Vehicle Extrication



### FIRE TRAINING

- Firefighter 101
- Firefighter 102
- Driver Operator
- Officer Development
- Hazmat
- Incident Safety



### EMERGENCY MEDICAL

- First Aid
- Anatomy
- Nursing
- Technician
- Responder
- Paramedic
- Infection Control & Prevention



### TECHNICAL SERVICES

- Automation
- Optimization
- Air Pollution
- Engineering
- Waste Reduction
- Agriculture
- Manufacturing



### SOFT SKILLS

- Buss. Strategy & Entrepreneurship
- Human Resources & People Management
- Sales & Marketing
- Communication
- Management & Leadership
- Training & Development
- Customer Service
- Personal Development
- Finance & Accounting
- Project & Process Management



### HEALTH & SAFETY



### SECURITY



### COMPUTER SKILLS

skillSTrain  
DISTRIBUTION



**NICHE MARKET**  
**LEARNING RESOURCES**

**LET'S CONTINUE TO  
PAVE THE WAY FOR THE  
FUTURE GENERATIONS**



+27 11 467 2730



[www.skillstrain.co.za](http://www.skillstrain.co.za)



23 hollyfern Rd, Fourways



[linda@skillstrain.co.za](mailto:linda@skillstrain.co.za)

Learn - Develop - Succeed

CHANGING THE OUTLOOK OF ON-LINE EDUCATION

# LEARN - DEVELOP - SUCCEED

Learn a new skill. On-line learning. Anywhere. Anytime.

[www.skillstrainlms.co.za](http://www.skillstrainlms.co.za)

➤ Register ➤ Select your course ➤ Pay online

and you can start in minutes. When you achieve 80% or more in the final assessment, you will immediately receive your certificate to download and print.

## Online learning has never been easier

Study anywhere, anytime, anyplace, at your own pace

Fast-track your career with affordable personal and professional on-demand learning

Online learning for your personal and professional development



Skillstrain is the national supplier of specialised training products for the ambulance, rescue and emergency services national departments

SkillTrain believes in creating a better future for Africa through education and the development of skilled workers. We endeavour to make education accessible to all, offering more opportunities, at a competitive cost on multiple platforms, allowing instant access to many of our products online.



Skillstrain now offers CPD Points accreditation for medical ethics courses

ANYONE HAS THE POWER TO SAVE A LIFE



CPR in 4 simple steps

**UPSKILL yourself and enrol TODAY**

Specialised course structure outlines include:

- Disaster management
- Medical emergency
- Fire training
- First responder programmes

Softskills courses include:

- Health and safety
- Technical skills
- Professional and personal development
- Computer skills

More than 400 courses available online

**skillSTrain**

Tel no +27 11 467-2633/2730 Cell 082 552 7742

**DISTRIBUTION** Pioneers in e-learning for Fire, EMS and Safety



[www.skillstrain.co.za](http://www.skillstrain.co.za) and [skillstrainlms.co.za](http://skillstrainlms.co.za) live



## MISSION, VISION AND PHILOSOPHY

Pioneering the Fire and Emergency Services forward by enabling a philosophy to train as many people in various regions at the same time through the SkillsTrain on-line platform. Saving time, resources and making specialised training accessible to all.



## SERVICES

SkillTrain Distribution is a supplier of niche market learning resources.

Disaster Management, Fire Training, Emergency Medical, Technical Services, Soft Skills

All available on [www.skillstrainlms.co.za](http://www.skillstrainlms.co.za)

✉ [linda@skillstrain.co.za](mailto:linda@skillstrain.co.za) | [susan@skillstrain.co.za](mailto:susan@skillstrain.co.za)  
 +27 (0)11 467 2730 | +27 (0)82 552 7742  
[www.skillstrainlms.co.za](http://www.skillstrainlms.co.za)  
[www.skillstrain.co.za](http://www.skillstrain.co.za)



Skillstrain is the preferred supplier of specialised training products for the ambulance, rescue and emergency services national departments

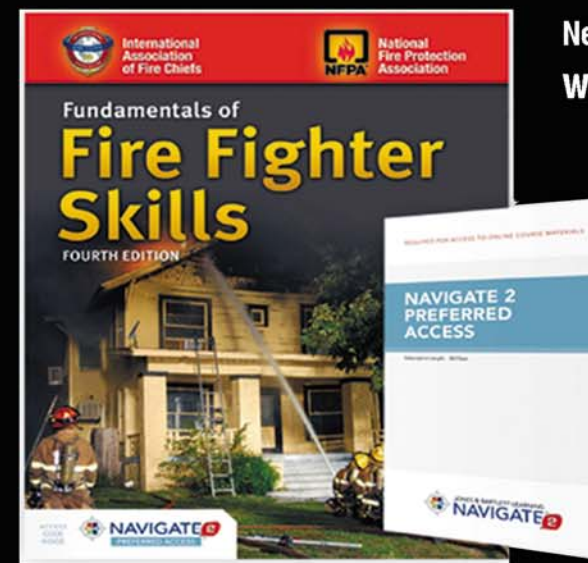

New localised and international courses available on [www.skillstrainlms.co.za](http://www.skillstrainlms.co.za)

**NEW AND REVISED STANDARDS**  
 Firefighting Basics: Firefighter I & II  
 Hazmat awareness and operations

Delivery formats:

- Online Interactive Course
- Online Streamed Video
- DVD

Log onto Skillstrain for over over 400 courses - [www.skillstrainlms.co.za](http://www.skillstrainlms.co.za)

**skillSTrain**

Tel no +27 11 467-2633/2730 Cell 082 552 7742

**DISTRIBUTION** Pioneers in e-learning for Fire, EMS and Safety



[www.skillstrain.co.za](http://www.skillstrain.co.za) and [skillstrainlms.co.za](http://skillstrainlms.co.za) live

- Ideal distance learning platform for courses such as Fire Officer
- Refresh
- Kickstart your career
- Be better prepared
- Get paid while you learn
- Perfect for upskilling





ETS provides emergency response training and services in the African continent and we strive to be the preferred emergency response partner. We hold a competitive advantage through the following:

- Excellent levels of service delivery
- Commitment to quality
- Accredited training programs
- and Ongoing client support

ETS Emergency Training Solutions (Pty) Ltd is now IFSAC Accredited. IFSAC Provides accreditation to entities that certify the competency of, and issue certificates to individuals who pass assessments based on the National Fire Protection Association (NFPA) Fire Service Professional qualifications. Accreditation is granted only after an integral self-study is conducted by the entity seeking accreditation, followed by an on-site review by a panel consisting of peer representatives from other member entities



**ETS can certify the following NFPA programs under IFSAC:**

- |  |                               |
|--|-------------------------------|
| Hazmat Awareness – NFPA 1072                                       | Hazmat Operations – NFPA 1072 |
| Hazmat Mission Specific: Personal Protective Equipment – NFPA 1072 |                               |
| Hazmat Mission Specific: Product Control – NFPA 1072               |                               |
| Hazmat Technician – NFPA 1072                                      |                               |
| Hazmat Incident Command – NFPA 1072                                |                               |
| Firefighter I – NFPA 1001  | Firefighter II – NFPA 1001    |
| Driver Operator – NFPA 1002  |                               |
| Fire Officer I – NFPA 1021   |                               |
| Fire Inspector I – NFPA 1031                                       | Fire Inspector II – NFPA 1031 |
| Fire Investigator – NFPA 1033                                      |                               |
| Fire Services Instructor I – NFPA 1041                             |                               |

**Other Services**

1. **Industrial Fire Fighting:** Fire awareness in the workplace to specialist fire teams and incident command
2. **Rescue:** Fall Arrest, Rope Rescue, Vehicle Extrication, Confined Space
3. **First Aid and BLS for Health care providers**
4. **Fire Prevention and Code Enforcement**
5. **Fire Investigation**
6. **Safety programmes**
7. **Provision of trained ERT Personnel**

**Accreditation and Certification**

1. Local Government Seta (LGSeta) – LGRS-EMsSr101117
2. Department of Labor – CI 663
3. Transport Education and Training Authority –PrDP(D) 2012/88
4. TETA – ACCREDITATION NO: TETA12-228
5. CETA – ACCREDITATION NO: 5R55079
6. ETDP SETA-PROGRAMME APPROVAL
7. FP&M SETA - The Fibre Processing and Manufacturing
8. QCTO – Quality Council For Trades & Occupations
9. Registered Assessment centre with QCTO
10. Southern African Emergency Services Institute (SAESI)

**Certification**

1. ISO 9001:2015
2. OHSAS 18001:2007

[www.etsafrica.co.za](http://www.etsafrica.co.za)  
[schedule@etsafrica.co.za](mailto:schedule@etsafrica.co.za)  
[Info@etsafrica.co.za](mailto:Info@etsafrica.co.za)

Tel: 016 363 0253/4  
 Cell: 074 347 3771  
 Fax: 016 363 1550





**RESCUE SOUTH AFRICA**  
Anytime. Anywhere in the World.



**DISASTER RESPONSE AND URBAN SEARCH & RESCUE TRAINING**

Rescue South Africa is a non-profit organisation dedicated to uplift African first responder resources by building robust search and response capacity within the emergency services arena over the last 12 years.

We have a comprehensive cache of equipment making us the only service provider with the ability to travel anywhere in South Africa to deliver training.



- BASIC RESCUE PRACTITIONER**
- High Angle 1 Rescue
  - Fire Search And Rescue
  - Motor Vehicle Rescue
  - Industrial And Agricultural Rescue



- BRIDGING COURSE**
- High Angle 1 2 Rescue



- WILDERNESS SEARCH AND RESCUE PRACTITIONER**
- Aquatic Surface Rescue (Swift Water And Small Boat Handling)
  - Aviation Rescue
  - Confined Space Rescue
  - Wilderness Search And Rescue



- URBAN SEARCH AND RESCUE PRACTITIONER**
- Hazardous Materials Rescue
  - Confined Space Rescue
  - Trench Rescue
  - Structural Collapse Rescue

We also offer bespoke training courses including Pump Operator, Breathing Apparatus and Heavy Lifting to various Fire Departments, Emergency Services personnel and corporate South Africa. There are two instructors per course and each course has a minimum intake of 10 delegates and a maximum of 14 delegates, ensuring that the instructor learner ratio is at best-practice standards.



Should you wish to invest in upskilling your emergency responders with the proper skills to mitigate disaster impact in your environment, please contact us for a competitive quote.

Telephone: (0)11 234-1545  
Mobile: +27 (0)82 459-9765  
Email: [ian@rescue-sa.co.za](mailto:ian@rescue-sa.co.za)

For further information please visit our website [www.rescue.co.za](http://www.rescue.co.za)



**Fire Protection Association of Southern Africa**  
**Courses/ Training**

(LGSETA/ CAA/ CFPA/ SAQCC/ SABS 1475 /IFE- UK / IISA/ FPA-UK accredited)

- Fire Risk Assessment & Prevention Strategies
- Advanced Fire Prevention
- Passive Fire Protection
- Fundamentals of Fire Investigation (NFPA 921)
- Advanced Fire Investigation Techniques (NFPA921)
- CFPA Principles in Fire Safety Engineering ( BS 7974)
- Plan Appraisal: A Dissection of SANS 10400- Parts A, T & W Bylaws
- Sprinkler Pumps Inspection and Operation
- Workplace Fire-fighting & Breathing Apparatus
- Basic Firefighting
- Fire-fighting and Evacuation Module
- Grass Firefighting
- Aviation Firefighting
- FPASA/ FPA UK Diploma in Fire Prevention

Contact: [college@fpasa.co.za](mailto:college@fpasa.co.za) or [support@fpasa.co.za](mailto:support@fpasa.co.za)  
011 397 1618/19



# OSHAfrica 2019 Conference



18 - 20 SEPTEMBER 2019  
EMPERORS PALACE JOHANNESBURG, SOUTH AFRICA  
www.OSHAfrica2019.com



OCCUPATIONAL SAFETY AND HEALTH IN AFRICA: CHALLENGES AND ACTIONS



# OSHAfrica 2019 Conference



OCCUPATIONAL HEALTH AND SAFETY IN AFRICA: CHALLENGES AND ACTIONS

## EXHIBITION AND SPONSORSHIP OPPORTUNITIES

Contact: Debbie  
Email: delinds@mweb.co.za  
Mobile: +27 83 266 6662



## CALL FOR ABSTRACTS and EARLY REGISTRATION

for the OSHAFRICA2019 Conference / 18 – 20 September 2019 **NOW OPEN!**

We are pleased to announce that early registration, scholarship application and abstract submission is now open for the OSHAFRICA 2019 Conference that will be held at Emperor's Palace, Johannesburg, South Africa from 18-20 September 2019.

The Conference theme is *Occupational Health and Safety in Africa: Challenges and Actions*.

Become part of this milestone event, meet industry leaders and touch base with friends and colleagues in the field.

### WHY YOU SHOULD ATTEND:

This historic event aims to bring together stakeholders from Africa and beyond to discuss the existing challenges in Occupational Safety and Health in Africa. It will be of interest to anyone who has an interest in translating these challenges into opportunities in the interest of the region and the world at large.

This event will be the inaugural conference of OSHAfrica, and marks the beginning of the international triennial conferences which will be held rotationally across the African continent.

This event is intended to be highly interactive, providing useful and meaningful deliberation about daily occupational safety and health issues across individual, organisational, national and regional levels.

The conference will provide the attendees with increased knowledge and know-how when having to make important decisions.

It will give attendees the confidence to return to their workplaces with the hope of inspiring change in occupational safety and health through positive actions.

This event will be the convergence of global OSH groups, Associations, Institutes, personalities and OSH resources together in Africa, with the hope of discussing simple workplace safety and health issues, with the aim of improving existing professional skills and practices within workplaces and amongst colleagues.

Attendees can look forward to an activity-packed programme with presentations from leaders and visionaries, get an update on the latest research and community activities, skills development programmes and exhibition displays.

This conference will be hosted in a combination of plenary sessions, parallel sessions, debates, skill building sessions, satellite sessions, an exhibition and entertainment.

### TOPICS:

- OSH in manufacturing, mining, construction, aviation, farming, oil and gas and healthcare workers etc
- Occupational safety and health leadership
- Improving health and safety in the informal sector
- OSH training and competency improvement
- Occupational health diseases, rehabilitation and return to work
- Occupational health assessment and fitness to work
- Mental health in workplaces
- Employee assistance programmes
- Workplace violence and assault
- Aged workforce and pre-retirement programmes
- Drug and alcohol abuse in the workplace
- Personal protective equipment
- Workplace inspection and audits
- Safety risk and control management
- Major Hazard Management
- Safety and Risk Management Systems
- Behavioural and Human Factor interventions

You are invited to **REGISTER** or **SUBMIT AN ABSTRACT** to become part of this all important Conference via the Conference website at: [www.oshafrica2019.com](http://www.oshafrica2019.com)

Please take advantage of the early registration discount that is now available at R5 865 (incl. 15% VAT ).

### FOR MORE INFORMATION ON THE CONFERENCE PLEASE VISIT:

Website: [www.OSHAfrica2019.com](http://www.OSHAfrica2019.com) | Email: [info@OSHAfrica2019.com](mailto:info@OSHAfrica2019.com)

Tel: 012 816 9070/9089/9149/9124





Tel: +27 11-701-5054  
 Fax: 086 684 2664  
 Email: admin@safety1st.co.za



**POSTERS FROM THE SAFETY FIRST ASSOCIATION**

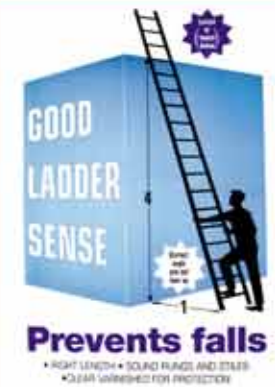

Do you want to keep your workplace safe?  
 Do you want to make sure that your workers return home safely and in good health every day?

Then you cannot afford to be without the  
**SAFETY HANDBOOK**

The most comprehensive Occupational Health and Safety Handbook that is available for the South African market



Tel: +27 11 701-5054  
 Email: admin@safety1st.co.za  
 www.safety1st.co.za

**SAFETY HANDBOOK**

For the South African industry and other workplaces



For all who have the safety of workers at heart

Author: S.A. KADIRI  
 Co-author: D. NIESING



- CONSTRUCTION SAFETY - H&S WORKPLACE REGULATIONS
- HEAT STRESS - RISK ASSESSMENTS - CONFINED SPACE ENTRY
- ELECTRICAL SAFETY - PSYCHOLOGICAL WELLBEING - BACK PAINS
- CHEMICAL HAZARDS - INDUSTRIAL SAFETY- FIRST AID - ERGONOMICS
- FIRE SAFETY - RISK INSPECTIONS - PERSONAL PROTECTIVE EQUIPMENT

- SAFETY POLICIES - EMPLOYER'S RESPONSIBILITIES
- HAZARD CONTROL - DEVELOPING A SAFETY PLAN
- EMERGENCY EVACUATION PLANS - VENTILATION
- HYGIENE - HAND TOOLS SELECTION - SKIN CARE
- WORKPLACE ACCIDENTS - WORKSTATION DESIGN

# Marcé Fire Fighting

## Refurbishment



# Marcé Fire Fighting

## Hydraulic Platform Refurbishment



### Lockers and Electronics

- Lockers removed and replaced
- Replaced all electronics and wiring



### Pump and Access

- Pump overhauled, new plumbing fitted and tested
- New improved stairs with easier access



### Outrigger and Battery Locker

- New outriggers mounted
- New pump operation station
- Batteries and extras replaced

## Mercedes Actross Hydraulic Platform



- Complete new lockers on both sides
- Complete refurbished 37m appliance mounted to chassis
- New rugged stairs for easy access
- Rebuilt entire cab
- New plumbing
- Complete new paint job
- Certified operational appliance
- Drive lines overhauled and major service on transmission
- 440 HP V6 Engine overhauled



Scan me

Excellence Through Innovation

"Products that SAVE lives"

[www.marce.co.za](http://www.marce.co.za) | [sales@marce.co.za](mailto:sales@marce.co.za)







### Wheels and Hosereels

- New tubeless rims and tyres
- Complete new hosereel and hose beds



### Rear and Interior

- New ISX Cummins motor with new cooling system
- Dash replaced c/w Marcé Integrated Electronic System



### Paint and Upholstery

- New upholstery and complete new paint job
- Chassis painted and checked



## Complete Refurbishment

- CUMMINS ISX 475HP
- ALLISON HT7500 TRANSMISSION
- GODIVA GV5410 5600 l/min @ 10 bar
- MARCE INTEGRATED CONTROL SYSTEM
- VOLKAN 4000 l/min ROOF TURRET
- FULL REFURBISHMENT



Scan me



# 4x4 Bush Fire Unit

- Marcé Bush Fire Unit
- Toyota land cruiser double cab 4X4
- Manual 5 speed transmission
- Ultra high pressure unit
- 50 l/min @ 100 bar
- 500 liter water tank
- 50 liter foam tank
- Rigid Industries dually intersection approach lights
- Rigid Industries chase high level running & brake lights
- Bullbar with integrated 9000 LB winch



"Products that **SAVE** lives"

[www.marce.co.za](http://www.marce.co.za) | [sales@marce.co.za](mailto:sales@marce.co.za)



# 4x4 Medium Rescue Pumper

- Scania P310 Double Cab 4X4, 310HP Engine
- Allison automated transmission
- Fully air conditioned crew cab with seating for a driver officer and four crew members c/w SCBA crew back rests
- Mid mounted Darley 3785 l/min normal pressure centrifugal pump
- FOAMPRO® class A foam proportioning system, trident around the pump class B foam proportioning system
- 3000L water tank, 150L class A foam tank, 150L class B foam tank
- 5 X body compartments 2 X cross lays on pump module
- Marcé integrated pump regulation control system
- Hella and rigid industries emergency lighting,
- Robotic light mast fully equipped with hydraulic rescue tools and fire fighting equipment



"Products that **SAVE** lives"

[www.marce.co.za](http://www.marce.co.za) | [sales@marce.co.za](mailto:sales@marce.co.za)





## Marcé 4x2 Heavy Rescue Vehicle

- Marcé Heavy Duty Rescue Vehicle
- Scania P310 chassis
- Allison automatic transmission
- Slide out dropdown storage
- Slide out storage at rear
- Storage on roof
- Custom manufactured heavy duty rescue body
- Various heavy duty rescue and lifting equipment



*"Products that **SAVE** lives"*

[www.marce.co.za](http://www.marce.co.za) | [sales@marce.co.za](mailto:sales@marce.co.za)



# CAFS Midship Major Pumper

- Marcé Major Pumper
- Scania P410 Chasis
- Allison automated transmission
- 4700 l/min @ 10 bar normal pressure
- 3200 Liter water tank
- 150 Liters class A & 150 Liters class B
- Marcé integrated control system
- Waterous CAFS system
- Fully equipped



"Products that **SAVE** lives"

[www.marce.co.za](http://www.marce.co.za) | [sales@marce.co.za](mailto:sales@marce.co.za)



# Marcé 6x4 9000 Liter Water Tanker

- Marcé 9000 Liter Water Tanker
- Scania P410 Chassis
- Allison automated transmission
- 4750 l/min @ 10 bar normal pressure
- 9000 Liter water tank
- 150 Liter class A & 150 Liter class B foam
- Marcé integrated control system
- Waterous CAFS system
- Fully equipped



*"Products that **SAVE** lives"*

[www.marce.co.za](http://www.marce.co.za) | [sales@marce.co.za](mailto:sales@marce.co.za)



# ARFF vehicles

Follow perfection.



## PANTHER 8x8

The Rosenbauer PANTHER is one of the most successful, efficient, and variable ARFF vehicles worldwide. Its multi-award-winning design and powerful performance make it the most modern fire fighting vehicle of our time. The PANTHER concept stands for optimal system integration of chassis, bodywork and fire fighting equipment.

With up to 1,450 hp, a maximum speed of 135 km/h, and up to 19,000 l of extinguishing medium capacity, the PANTHER 8x8 sets the standard for engine power and extinguishing power. In addition, the 10,000 l/min of pump output and acceleration from 0 to 80 km/h in less than 25 seconds put the model in a class of its own.

[www.rosenbauer.com](http://www.rosenbauer.com)

# Municipal vehicles

Efficiency in procurement and upkeep.



## ET Efficient Technology

The ET series is developed and built for international municipal and mining applications. ET combines tried and tested Rosenbauer technologies with a consistently economical construction method. High degree of standardization with a variety of modular design options and a large number of optional components! This combination makes ET an efficient all-rounder with the exact equipment you need for your operations. The ET series is proudly built in South Africa.

 **rosenbauer**

# Aerial ladders

## Operational quality at the highest level.



### Aerial ladder L56

Regardless of whether narrow streets, next to parked cars, or in dense urban parks – the scenes where aerial ladder vehicles are deployed differ just as much as the requirements for live loads and functionality. Behind the height classes of the Rosenbauer turntable ladders is a well thought-out concept that is 100 % oriented to the requirements and advantages of fire services worldwide.

With a working height of 56.2 m and a set-up time of 120 s the L56 is providing emergency crews with best possible support in their work. The Rosenbauer ladder can get as an option the Rescue Lift which will assure a rescue rate of 18 people within 12 min from 56 m above ground.

[www.rosenbauer.com](http://www.rosenbauer.com)

### Personal protective equipment.



**HEROS-titan firefighting helmet.**  
Harder than any operation. The new generation of HEROS firefighting helmets.



**FIRE MAX 3 protective suit.**  
Next generation protection and wearing comfort.



**TWISTER protective boots.**  
Lightening fast to put on and take off.



**SAFE GRIP 3 protective gloves.**  
The protective gloves for the professional firefighter.

### Firefighting systems.



**FOX - the powerful and premium portable fire pump.**  
The following is decisive in the application of portable fire pumps: power - weight - reliability - easy operation.



**FOX S - a class of its own.**  
The completely new developed FOX S portable pump is an impressive new class between FOX and BEAVER.



**BEAVER - the innovative power package.**  
The BEAVER portable pump impresses with low weight, compact dimensions and is equipped with a new priming pump.



**UHPS - Ultra high pressure system.**  
Efficient and compact system for first attack.

### Full-range supplier

Our greatest strength is our flexibility. No matter what fire departments need, Rosenbauer offers everything conceivable in terms of fire-fighting equipment. The product offerings range from personal protection equipment through technical equipment to special hazmat equipment.

Please request the Rosenbauer catalogue with more than 3000 firefighting articles.







BBBEE Compliant  
Proudly Manufactured  
in South Africa



# The Future of Emergency Vehicles



### KWAZULU-NATAL

36 Prospecton Road, Prospecton,  
Durban, 4133  
T +27 31 902 6443



### GAUTENG

33 Industry Road, Clayville X4,  
Olifantsfontein, 1665  
T +27 11 316 4161 • F +27 11 316 4005



### EASTERN CAPE

2 Penkop Street, Woodbrook,  
East London, 5200  
T +27 43 736 3235

[jacok@tfm.co.za](mailto:jacok@tfm.co.za)/[info@tfm.co.za](mailto:info@tfm.co.za)

BLACK CHERRI

Designs



Specialist in  
Graphic & Packing design

including all other marketing collateral servicing the  
Engineering and Emergency Services Field.  
From concept, design, dtp to print.

B  
R  
O  
C  
H  
U  
R  
E

adverts

L  
A  
F  
L  
Y  
E  
R  
S

POSTERS

Mobile: 082 876 8054 | blackcherri.singh@gmail.com

# ADVERTISERS' PROFILES



ChemSystems a Division of AECL provides a diverse range of specialty products, services and chemical solutions to a wide customer base across several industries.

Industrial & Mining a business unit in ChemSystems has an extensive range of products for Industrial applications including fire protection, cleaning, lubrication, metal-working, non destructive testing, marine and offshore services.

#### Contact ChemSystems (Pty) Ltd

Gauteng

200 Bergvrierv Drive Chlookop Ext 24 Kempton Park

Tel: +27 (0)11 922-1600

Fax: +27 (0)11 976-1706

Mason Naidoo

Tel: + 27 (0)11 922-1805/1600

Mobile: + 27 (0) 79 514 6907

Email: mason.naidoo@chemsystems.co.za

Cape Town and Coastal

No 245 Fitzmaurice Avenue, Eppindust 2, Cape Town

Tel: + 27 (0)21 534-5231

Fax: + 27 (0)21 534-6710

André Schütte

Tel: + 27 (0)21 534-5231

Mobile: + 27 (0)83 252 1411

Email: andre.schutte@chemsystems.co.za

www.chemsystems.co.za



plantfocus

Aerotecnica Coltri© produces a range of portable compressors and big sized recharging station, including petrol, diesel, mono and three phase electric engines. These are high pressure compressors used in the Fire Fighting – Paintball, CNG and Scuba industries.

Coltri compressors in the scuba market can be used to pump nitrox with a O2 % up to 40 % Coltri offers a number of nitrox membrane solutions at very affordable prices Aerotecnica Coltri©, established in 1982, designs and produces high pressure compressors for breathable air and technical gases: Nitrox, Trimix, Helium and Methane.

**Plantfocus** - South African distributors of the Coltri brand.

Coltri in South Africa is a owner run business with the focus

on delivering exceptional service. Realising the demanding needs of the fire fighting and scuba markets and being able to satisfy these needs has made Coltri a trusted name in the market. With some of the early machines supplied over 27 years ago in the local market still in daily use it shows the durability and quality of the product.

As well as their extensive range of scuba diving products - Coltri also produce a range of wetsuits that are 100 % made in SA

The wetsuit factory offers a unique service of a Tailor Made wetsuit for the perfect fit and optimal comfort.

Other agencies that Coltri have acquired are in the gas boosting and blending of technical diving gases – namely oxygen and helium

These agencies are MPS Technology as well as NTS Dive Coltri also import the Vitkovice scuba cylinders which get Coltri Sub branding

#### Contact Coltri South Africa - Plantfocus cc

Tel: +27 (0)11 402-3542

Fax: 086 743 3851

Mobile: +27 (0)82 449 3576

Email: sales@coltri.co.za / steve@coltri.co.za

Websites

www.coltri.com

www.coltri.co.za

www.ntsdiver.com

www.mpstechnology.it/en



DELINDS  
PUBLICATIONS

Delinds Publications cc was launched in 1990 to publish the Emergency Services Yearbook & Buyer's Guide after writing "100 Years of Service" - the first 100 years of the Johannesburg Fire Department.

Delinds Publications are publishers of the following:

- Emergency Services Yearbook & Buyer's Guide
- National Safety & Corporate Risk Management
- Annual Occupational Health & Safety Directory
- Journal of the Mine Ventilation Society of Southern Africa.

#### Contact Delinds Publications cc:

Debbie Myer

Mobile: +27 (0) 83 266 6662

Tel: +27 (0)11 886-5985

Fax: +27 (0)11 886-1332

Email: delinds@mweb.co.za

www.emsguide.co.za

## DESIGNATION HOSE (PTY) LTD

Designation Hose was established in 1992 servicing, amongst others, the fire fighting industry. From small beginnings Designation has expanded and acquired some world class agencies for Africa:

- Productos Mesa (Spain) - Premium quality fire hose
- Gomtex - Nitrile rubber hose
- Gomdur - 4 layer hose
- Genfo bag - for forestry requirements
- Atlas - Single and Double jacket hose
- Protek - Fire fighting nozzles and equipment
- Red Head Brass - Fire fighting couplings and adapters
- Brute - expanders

Designation Hose also represents Goodyear, Dunlop, Alfagomma and have representation in all major cities.

Designation pride themselves on excellent service, and carries stocks of fire hose in popular sizes as well as all the widely used Protek branches and monitors. Included in our range are nozzles such as the Multipurpose units which produce steam and fog simultaneously and the automatic with slide valve control.

### Contact Designation Hose

Chase Remington and Chris Beedle

16 End Extension Street

City and Suburban

Johannesburg

Tel: +27 (0)11 791 6730

www.designationhose.com

sales@designationhose.com

## Divetek Compressors

Divetek Compressors was the brain child of Andre Vosloo, under his guidance with David Cohen the Director of Divetek Pty - David Cohen - Divetek Compressors was born. Initially Andre simply "freelanced" as a compressor technician since leaving a major competitor in 2016.

With the recent joining of Corné Grobbelaar to the team it was evident that there was a lack of technical expertise available within high pressure applications in South Africa not only within the "breathing air" systems but also within industrial and military systems.

We have grown from strength to strength and now provide comprehensive services within the industry.

Divetek now as a group of companies and multiple branches provides turnkey solutions both within the scuba industry and within high pressure applications.

We also import and hold distribution rights on a number of major brands, Faber Cylinders, Luxfer Cylinders, Midland Diving Equipment, OTS Ocean Technology Systems, Paramina Compressors, Orca Torch, Deepblu Diving Computers, San-O-Sub Diving Equipment, as well as our own range of imported Divetek Diving Gear.

Our Johannesburg premises has been recently extended and now covers 1400sqm from where stock is on hand and we supply directly to the public - visit [www.divetek.co.za](http://www.divetek.co.za) for a full listing of products and services available.

### Contact Divetek Compressors

Unit 14, Skyview Retail Park,

CNR CR Swart and Freda Road. Bromhof, Johannesburg.

Tel: +27 (0)11 791 1095

Email: [sales@divetek.co.za](mailto:sales@divetek.co.za) / [compressors@divetek.co.za](mailto:compressors@divetek.co.za)

[www.divetek.co.za](http://www.divetek.co.za)

## **dosetech fire** special risk fire protection

DoseTech Fire is the new trading name for DoseTech (Pty) Ltd, specialists in special risk fire protection equipment.

DoseTech Fire is the supplier of a select range of high quality special risk fire protection hardware for the African petrochemical, mining and general special risk fire protection industries. We apply our experience and knowledge to assist with product selection, supply, service and maintenance to satisfy customer's needs and build lasting relationships.

Our high quality brands are manufactured by leading USA, German and UK companies guaranteeing our customers reliability and value for their investment. Majority of the products are FM, VdS, UL compliant and have NFPA approval ensuring quality performance and long service life.

DoseTech Fire proudly represents the following manufacturers: -

- FireDos® GmbH - Foam Admixing FM approved proportional water driven foam dosing pumps and wall hydrant cabinets
- AKRON Brass Co. - Top quality FM approved fixed and oscillating monitors and hand held nozzles
- AKRON Brass Co.- Severe Duty water cannons for mining vehicle wash down applications and dust suppression water tanker mounting
- Mueller Co. - Fire Protection gate and butterfly valves FM/UL approved for Hydrant isolation and pipe lines.
- James Jones - Fire hydrants FM/UL approved in ductile iron and brass.
- Johstadt - HP petrol and diesel driven portable fire fighting water pumps.
- Dr Sthamer - Foam concentrates

DoseTech Fire offers design preview service, on-site commissioning and servicing of our FireDos foam pump systems, and technical assistance with all our products.

Service contracts are also provided on request.

### Contact DoseTech Fire:

Tel: +27 (0)861 111 544

Email: [mgf@dosetech.co.za](mailto:mgf@dosetech.co.za)

Mike Feldon on: +27 (0)83 251 9346

View: [www.dosetech.co.za](http://www.dosetech.co.za)

# Dräger

### Our guiding philosophy

Dräger. Technology for Life®

### Our guiding principle

Dräger is technology for life. Everyday, we live up to that responsibility by putting all of our passion, knowledge and experience into improving lives with outstanding and innovative technology that puts life first.

We dedicate our efforts to those who depend on our technology the world over, to the environment, and to a better future.

### Contact: Dräger South Africa (Pty) Ltd

Sales and Service

Johannesburg

PO Box 4676, Rivonia 2128

Tel: +27 (0)11 059 4200

Fax: +27 (0)11 465 6953

Cape Town

PO Box 3677, Tygervalley 7536

Tel: +27 (0)12 552 6715

Fax: +27 (0)12 552 6713

Durban

PO Box 40554, Redhill 4071

Tel: +27 (0)13 563 6342

Fax: +27 (0)13 563 6847

Email: [customer\\_care\\_za@draeger.com](mailto:customer_care_za@draeger.com)

[www.draeger.co.za](http://www.draeger.co.za)



### The miracles of science™

For over 200 years, DuPont has established a global reputation for excellence in safety management.

DuPont is dedicated to protecting more people, from more hazards, in more places around the world. As a premier innovation company in safety and personal protection, DuPont discovers and delivers specialised products and solutions to help our customers solve complex problems.

In addition to this, DuPont has developed an extensive line of products and services targeting the needs of first responders and first receivers. These include a wide range of proven, science-based solutions including some of the most trusted brands in the industry.

In the emergency response segment, DuPont is a global leader in the supply of Nomex® heat and flame protection for fire fighters, petrochemical and utility workers.

In addition, DuPont produces and supplies a full range of chemical protective clothing, namely the Tyvek® and Tychem® portfolio, encompassing EN approved, Type 6, 5, 4, 3, 2 and 1.

### Contact DuPont for Chemical Industrial

34 Whitely Road, Block B, 1st Floor,

Melrose Arch

Tel: +27 (0)11 218-8654

Loren Pearson Cell: +27 (0)82 377 6765

Email: [loren.pearson@dupont.com](mailto:loren.pearson@dupont.com)

### Contact DuPont for Thermal Apparel

34 Whitely Road, Block B, 1st Floor,

Melrose Arch

Tel: +27 (0)11 218-8686

Dharmesh Lakmidas Cell: +27 (0)72 098 0791

Email: [dharmesh.lakmidas@dupont.com](mailto:dharmesh.lakmidas@dupont.com)

### Contact DuPont for Marketing Communications

34 Whitely Road, Block B, 1st Floor,

Melrose Arch

Tel: +27 (0)11 218-8674

Noleen Clarke Cell: +27 (0)78 459 8738

Email: [Noleen.clarke@dupont.com](mailto:Noleen.clarke@dupont.com)



ETS Emergency Training Solutions (Pty) Ltd specialise in Emergency Response Services, Training and Management Solutions to all types of Industries, including Mining, Power Generation and anywhere employers need to understand the importance of having a trained, competent and prepared emergency response capability.

We are based in South Africa and provide our services throughout South Africa and Africa.

ISO 9001:2015 and OHSAS 18001:2007 Certification

ETS Emergency Training Solutions (Pty) Ltd is ISO 9001:2015 certified (Initial Certification September 2016). ETS has also been certified for OHSAS 18001:2007 (Initial Certification January 2018).

### Training

ETS Emergency Training Solutions (Pty) Ltd is an accredited training provider with the South African Qualifications Authority (SAQA) to present various emergency responses and safety related training programmes.

Training programmes are designed to assist learners to respond to and assist at an emergency incident.

Training programmes are developed to meet international accepted standards and can be grouped to achieve formal qualifications.

The emphasis is on practical skills and application of these skills in a workplace incident or accident.

### IFSAC Accreditation

IFSAC Provides accreditation to entities that certify the competency of, and issue certificates to individuals who pass assessments based on the National Fire Protection Association (NFPA) Fire Service Professional qualifications. Accreditation is granted only after an integral self-study is conducted by the entity seeking accreditation, followed by an on-site review by a panel consisting of peer representatives from other member entities. ETS Emergency Training Solutions (Pty) Ltd is now approved to certify the following NFPA programs under IFSAC: International Fire Service Accreditation Congress.

- Hazmat Awareness – NFPA 1072
- Hazmat Operations – NFPA 1072
- Hazmat Mission Specific: Personal Protective Equipment – NFPA 1072
- Hazmat Mission Specific: Product Control – NFPA 1072
- Hazmat Technician – NFPA 1072
- Hazmat Incident Command – NFPA 1072
- Firefighter I – NFPA 1001
- Firefighter II – NFPA 1001
- Driver Operator – NFPA 1002
- Fire Officer I – NFPA 1021
- Fire Inspector I – NFPA 1031
- Fire Inspector II – NFPA 1031
- Fire Investigator – NFPA 1033
- Fire Services Instructor I – NFPA 1041

#### Training programmes consist of the following

##### 1. Firefighting:

Fire awareness in the work place to specialist fire teams and incident command

##### 2. Rescue:

Working at height to Advanced and Technician levels for rescue specialists.

##### 3. Hazmat:

Product specific emergencies and response to Hazmat Technician and Incident command

##### 4. First Aid:

##### 5. Fire Prevention and Code Enforcement

##### 6. Fire Investigation

##### 7. Various Safety programmes

ETS Emergency Training Solutions (Pty) Ltd has presented training in the following countries:

1. South Africa
2. Namibia
3. Mozambique
4. Tanzania
5. Zambia
6. Burkina Faso
7. DRC
8. Seychelles
9. Lesotho
10. Mali
12. Mauritania
13. Botswana

#### Emergency Team support

ETS Emergency Training Solutions (Pty) Ltd provide trained and competent team support to industry, by providing the services of emergency response personnel.

The service entails pro-active and re-active functions in preventing and mitigating the effects of fire, rescue, medical and HAZMAT incidents.

At the core of the emergency response strategy is the capability to have Personnel that have Equipment and are Trained (PET Principle), and our strategies strive to achieve this.

#### Emergency Response Management Services

ETS Emergency Training Solutions (Pty) Ltd assist employers to evaluate emergency response capabilities, by assisting with incident simulation exercises.

These simulations are based on realistic and possible incidents.

Simulation assessments allow for employers to have a clear understanding of what their response capabilities can do and what the state of readiness is.

Comprehensive feedback sessions and reports after these simulation exercises allow for management to take informed and factual decisions on what is required to maintain and improve on their emergency response readiness.

#### Contact ETS Emergency Training Solutions

Tel: +27 (0)16 363 0254/3

+27 (0)16 363 1570

Cell: +27 (0)74 347 3771 or 074 (firesq1)

Fax: +27 (0)16 363 1550

Email: [schedule@etsafrica.co.za](mailto:schedule@etsafrica.co.za) /

[info@etsafrica.co.za](mailto:info@etsafrica.co.za)

[www.etsafrica.co.za](http://www.etsafrica.co.za)



**FIREBREAK SA**  
SAFETY APPLIANCES PTY LTD

Firebreak SA (PTY) LTD is a Level 1 BBBEE company that supplies "technically advanced" safety and fire solutions. Their product range encompasses a wide range of products such as permanent and portable breath testers; gas detection equipment; chemical suits; fall arrest devices; confined space escape and many more.

Firebreak SA provide training and full service back up to this range of equipment:-

- MSA Authorised Agent (SCBA's / Gas Detection)
- LIFELOC Portable and Permanent Breath Testers
- DU PONT range of chemical suits
- TFT / Vanguard Fire Fighting Products
- Bullard / Viking Fire Protective Equipment
- LYMAE Advanced Fire Protective suits & coveralls
- LATCHWAYS Fall Arrest / Height Safety Solutions
- Fire Servicing / inspections / Detection systems (SABS Accredited)

#### Contact Firebreak SA (PTY) LTD ...

offering exceptionally fast service backed up by "staff steeped in experience" ... willing to help you solve your every problem.

Tel no: +27 (0)11 908 6960

Website : [www.firebreaksa.co.za](http://www.firebreaksa.co.za)

#### Team Members:

Duncan Ramsden 082 787 6484 [duncan@firebreaksa.co.za](mailto:duncan@firebreaksa.co.za)

Blane De Meillon 079 493 7958 [blane@firebreaksa.co.za](mailto:blane@firebreaksa.co.za)

Paddy Mallett 063 692 5304 [paddy@firebreaksa.co.za](mailto:paddy@firebreaksa.co.za)

Freddie Allworth 082 568 0164 [freddie@firebreaksa.co.za](mailto:freddie@firebreaksa.co.za)



The Fire Protection Association of Southern Africa (FPASA) was established in 1973 to provide a specialized fire safety management, technical and training service to industry, commerce and society at large.

Over the years the Association has developed a range of membership options and technical, training and fire safety management services that are recognised for their quality, professionalism and value.

Today the role of the FPASA covers education, information, advice, consultancy and training (Fire College).

The Fire College is a professional training centre dedicated to assist in the reduction of life and property losses in the Southern African region. It provides training on request of FPASA members and non-members alike, and in addition, provides original training programmes to suit the broad spectrum of industrial, commercial, institutional, local authority and insurer requirements.

The Technical Division includes the Library which offers a support service to the FPA Fire College and to FPASA members. The division offers specific insurer services and a range of fire safety management consulting services to members and clients.

The Administration and Services Division of the FPASA provides administration support to the Fire College and Technical Division. It also facilitates membership support and publication sales.

Our categories of membership and associated benefits will add value to any institution or business having an interest or involvement in fire engineering, fire protection, fire prevention or fire safety management.

The organisation enjoys extensive accreditation and approval including:

- LGSETA ETQA accreditation for the training courses
- ISO 9001: listing for the quality management system
- SABS 1475 accredited fire equipment workshop
- IFE (UK) academic recognition for the Fire Investigation Course
- CAA accreditation of both flight and cabin crew fire-fighting training courses
- SAQCC (Fire) accreditation for the fire Appliance Reconditioning course
- Botswana Qualifications Authority (BQA) accreditation and recognition

We also presently have a BEE Level 4 status.

#### Premises and facilities

The FPASA operates from purpose-built premises in BOKSBURG on a site of over two Hectares consisting of;

- An administration block accommodating the main reception area, a fire safety library, museum/memorabilia display facilities and offices

- A fire college building with three lecture rooms, an auditorium, fire museum/ memorabilia display area
- A fire house area with a lecture area, technical workshops and indoor live fire facility
- A large outdoor fire facility with fixed installation demonstration rigs and a drill ground

#### Contact Fire Protection Association of Southern Africa

PO Box 15467 Impala Park 1472

Springbok Road Bartlett Boksburg

Tel: +27 (0)11 397-1618

Fax: +27 (0)11) 397-1160

Satellite Tel: +27 (0)11 552-6908

Managing Director: Renay Sewpersad

Email: [renay@fpasa.co.za](mailto:renay@fpasa.co.za)

Head of Technical: Lynley Carols

Email: [LynleyC@fpasa.co.za](mailto:LynleyC@fpasa.co.za)

Executive Assistance: Neo Dichabe

Email: [Neo@fpasa.co.za](mailto:Neo@fpasa.co.za)

[www.fpasa.co.za](http://www.fpasa.co.za)



FREM TAC Fire & Rescue is a dynamic company based in South Africa that was established to fulfil the equipment and logistical needs of the emergency services in Southern Africa.

Our Purpose is to be of service to all clients within our identified target markets in Africa.

Our Mission is to save life and property by providing services that meets international standards, quality products, services, education and information.

Our Aim is to become the market leader in what we offer in the various fields by:

- Aspiring high standard of excellence
- Maintaining a high standard of honesty and integrity
- Clear and uninhibited customer relation and focus
- Acknowledge and accept social and environmental responsibility
- And beyond all else, setting the standard for others to follow.

We are always available to assist our clients with any emergency situation.

We offer the following products and services:

- Technical and rope rescue equipment
- Firefighting equipment
- Hydraulic rescue tools
- Safety eye wear
- Ventilation equipment
- Fire/rescue safety cutting blades (Lifetime Warranty)
- Line deployment equipment
- Self-contained breathing apparatus
- Oil, gas and mining industry consultation
- Firefighting hoses, nozzles and foam making equipment
- Fire fighting vehicles and special equipment

- Vehicle extrication gloves
- All types of fire ground ladders
- Forcible entry and lifting bag equipment
- Firefighting PPE
- Firefighting foam concentrates
- Composite SCBA Cylinder – Unlimited Lifecycle (Class 4)
- Thermal imaging cameras (TICs)
- Portable fire fighting pumps
- Fire Ground Ladder Service, Repairs and Mandatory Annual Load Testing

**Contact Fremtac for a free quotation and advice**

Jimmy Croucamp  
 Mobile: +27 (0)82 412 6319  
 Office: +27 (0)21 975 8540  
 Fax: 086-656-9427  
 Email: jimmy.c@fremtac.com  
 www.fremtac.com



Godiva Limited is the world's leading provider of specialist equipment for the emergency services market.

With extensive manufacturing facilities in the United States and Europe, and representative offices and distributors throughout the world, Godiva produces truck mounted and portable fire pumps and the Class 1 range of electronic instrumentation.

Godiva Limited is the home of the internationally recognised GODIVA brand of fire pumps, which are to be found in service in more than 100 countries.

Godiva Limited is an independent manufacturer with decades of experience in fine-tuning products at the heart of the life-saving business.

**Contact Godiva Limited**

Daniel Janse van Rensburg - Regional Manager - Africa  
 South African Mobile: +27 (0)83 263 1796  
 Email: godiva.africa@idexcorp.com  
 Skype: danielvr50  
 www.godiva.co.uk / www.haleproducts.com

## Hamilton Hydraulic Services cc

Hamilton Hydraulic Services was incorporated in 1995 to supply, service and repair Hydraulic Rescue Equipment, our primary market being the EMS and Fire and Rescue Departments.

Hamilton Hydraulic Services began its association with Godiva in 1996 and was appointed as their Sole Distributor for the repair of Hurst "Jaws of Life" Rescue Equipment in Southern Africa and later was appointed as Sole Distributor

directly by Hurst in the USA. Hurst "Jaws of Life" rescue tools have been in the market for nearly 50 years and are presently part of the IDEX Corporation.

Hamilton Hydraulic Services became associated with Lukas - Germany - in 2002 and has been their Sole Distributor since 2010 for the supply of Hydraulic Rescue Equipment, e-Drainic Rescue Equipment and Industrial Tools. Lukas, also part of the IDEX Group since 1995, produced their first rescue tools in 1972.

Hamilton Hydraulic Services became associated with Vetter - Germany - in 2002 and has been their Sole Distributor since 2010 for the supply of Lifting bags and accessories. Vetter, also part of the IDEX Group since 2004, produced their first lifting bag in 1971.

The Company operates from their premises in Gauteng and has a fully equipped workshop facility and staff experienced in the service and repairs to all makes of Hydraulic Rescue Equipment. They are also able to loan rescue equipment to Customers while their equipment is being serviced or repaired.

The following is a list of all products currently available from Hamilton Hydraulic Services, as the Sole Supplier.

- Lukas Jaws of Life Rescue Tools
- Vetter Lifting Bags
- Hurst Jaws of Life Rescue Tools
- Lukas Industrial Cutters
- Lukas Industrial Hydraulic Tools

A full range of spares is readily available for a minimum of 10 years on all products.

**Contact: Hamilton Hydraulic Services cc**

Unit 26, Route 24, Fleming Road, Meadowdale, 1614  
 Tel: +27 (0)11 828 1083  
 Cell: +27 (0)82 893 1883  
 Fax: +27 (0)11 822 5397  
 e-mail: hhshurst@netactive.co.za / hhsadmin@netactive.co.za  
 Web Addresses: www.jawsoflife.co.za  
 www.jawoflife.com  
 www.lukas.com  
 www.vetter.com



For more than half a century, Holmatro has been developing, producing, selling and servicing high-pressure hydraulic rescue equipment for Fire and Rescue Organisations. Based on the needs of end users and manufactured at two state-of-the-art production plants in the Netherlands and the USA, Holmatro products are known for their high quality and innovative technology. Holmatro rescue tools are sold and serviced all over the world through offices in various countries and an extensive dealer network.

When it comes to rescue equipment, Holmatro's highly experienced engineers translate innovative ideas into smaller, lighter and more powerful tools for the Fire and Rescue Service. The result is a full range of high-quality rescue

equipment enabling you to work efficiently under pressure. Holmatro tools are designed to help you to save lives quicker, easier and safer.

Excellence in performance, innovation and quality are the three pillars of the Holmatro organisation. They are the reason why our products last for years and why Holmatro is the brand of choice for rescue professionals throughout the world. Once you start using Holmatro tools, you will use them for life!

More information on: [www.holmatro.com](http://www.holmatro.com)

**Contact Holmatro Sales & Service South Africa**

The Rescue Tool Guys (Pty) Ltd  
 Sales Director - Johan Muller  
 Mobile: +27 (0) 82 609 3438  
 Tel: +27 (0) 11 823 2481  
 Email: [johan@trtg.co.za](mailto:johan@trtg.co.za)



When selecting the right partner for your emergency services needs, it is essential that you select a supplier that will not only sell you the product but one that will also ensure that it is well maintained and the warranties are honoured.

Marcé exists as a company that enables Emergency Services personnel to Save Lives. "No more, no less".

As a client you have to ask yourself the following: "Will I send the equipment I purchase to save my child?"

At, our Research and Development Department, new innovations and continuous improvement are part of our daily activities.

Marcé recently launched its brand new Custom Rhino ARFF vehicle range, the new Mamba 6000 lpm roof monitor as well as new management software for fire services.

Marcé is committed to South African job creation and local content in all our products. We currently manufacture all of our fire fighting vehicles locally in our 8400m<sup>2</sup> manufacturing plant in Centurion, South Africa. We have started to manufacture basic fire trucks at our Cape Town workshop. Marcé currently has a staff complement of 150.

Marcé is very proud to showcase its various new innovations and products, ensuring that our clients receive the best of care and excellent quality products. Each enquiry motivates our sales team to leave no stone unturned in finding the right product to ensure the best value for money and maintain the high standards the Emergency Services deserves.

### OUR MISSION

"To provide innovative and quality products at a competitive price with unequalled customer support enabled by our after-sales footprint in Africa."

With our mission in mind, Marcé, with its extensive product

range is in a position to offer a one-stop turnkey solution to its valued clients.

This solution enables a client who literally has nothing; to walk into a fully furnished fire station and start to operate.

### MARCÉ AFRICAN FOOTPRINT

Mozambique	+258 8 433 82736
Namibia	+264 6 250 0111
Zimbabwe	+263 7 727 33610
Botswana	+267 7 131 5823
Namibia	+264 6 250 0111

**Contact Marcé Fire Fighting Technology (Pty) Ltd**

1012 Ergon Road, Lyttelton, RSA  
 P O Box 8361, Centurion, 0046 RSA  
 Tel: + 27(0)12 742 9200  
 Fax: + 27(0)12 742 9299  
 E-Mail: [sales@marce.co.za](mailto:sales@marce.co.za)  
 Website: [www.marce.co.za](http://www.marce.co.za)



The OSHAfrica 2019 Conference, from 18 - 20 September 2019 will be a historic event that aims to bring together stakeholders from Africa and beyond to discuss the existing challenges in Occupational Safety and Health in Africa. It will be of interest to anyone who is involved in OSH.

This event will be the inaugural conference of OSHAfrica, and marks the beginning of the international triennial conferences which will be held rotationally across the African continent.

This event is intended to be highly interactive, providing information and intensive discussions about daily occupational safety and health issues across individual, organisational, national and regional levels.

The conference will provide the attendees with increased knowledge and know-how when having to make important decisions.

This event will be the convergence of global OSH groups, Associations, Institutes, personalities and OSH resources together in Africa.

The Conference theme is *Occupational Health and Safety in Africa. Challenges and Actions.*

Topics will include: OSH in manufacturing, mining, construction, aviation, farming, oil and gas and emergency services; Occupational health diseases, rehabilitation and return to work, health assessment and fitness to work; Mental health in workplaces; Workplace violence and assault; Aged workforce and pre-retirement programmes; Drug and alcohol abuse in the workplace; Personal protective equipment; Safety risk and control management; Major Hazard Management; Safety and Risk Management Systems

**Contact Foundation for Professional Development**

Tel: +27 (0)12 816 9070/9089/9149/9124  
 Email: [info@oshafrica2019.com](mailto:info@oshafrica2019.com)  
 Website: [www.oshafrica2019.com](http://www.oshafrica2019.com)



Rescue South Africa is an NGO, registered in 2001 in the Republic of South Africa as a Not-for-Profit Organisation whose goal is to develop the Urban Search and Rescue Capacity within South Africa and the SADC region.

#### Response

We are a Disaster Response Team that was established in 2001. We have responded to the following major International disasters:

- 2001 Earthquake – Gujarat, India
- 2003 Earthquake – Algeria
- 2003 Earthquake – Iran
- 2005 Earthquake – Pakistan
- 2010 Earthquake – Haiti
- 2011 Earthquake & Tsunami – Japan
- 2013 Typhoon Haiyan – Philippines
- 2015 Floods – Malawi

#### Expectation

We organise and facilitate co-operation between all relevant bodies with the aim of rendering the best possible technical rescue and emergency medical care, should such a need arise. In the event of such an emergency we use specialised equipment from our extensive cache to respond.

#### Capacity

RSA is at present fully equipped and able to respond nationally and internationally to the following incident types:

- Structural Collapse
- Trench Rescue
- Confined Space Rescue
- High Angle Rescue
- Swift Water and Flood Rescue
- Mass Transit Accidents
- Heavy Vehicle Accidents

#### Training

We offer top quality rescue training courses for fire and associated personnel. Our curriculum of courses is modular and include the University of Johannesburg accredited Advanced Rescue Practitioner(USAR) qualification:

##### BASIC RESCUE PRACTITIONER

- High Angle 1 Rescue – 10 days – NQF Level 5
- Fire Search and Rescue – 5 days – NQF Level 5
- Motor Vehicle Rescue – 10 days – NQF Level 5
- Industrial and Agricultural – 5 days – NQF Level 5

##### BRIDGING COURSE

- High Angle 2 Rescue – 10 days – NQF Level 6

##### WILDERNESS SEARCH AND RESCUE PRACTITIONER

- Aquatic Surface Rescue (Swift Water and Small Boat Handling) – 10 days - NQF Level 7
- Aviation Rescue – 5 days– NQF Level 7

- Wilderness Search and Rescue – 10 days - NQF Level 6
- ##### URBAN SEARCH AND RESCUE PRACTITIONER

- Hazardous Materials Rescue – 5 days – NQF Level 7
- Confined Space Rescue – 5 days – NQF Level 7
- Trench Rescue – 10 days – NQF Level 7
- Structural Collapse Rescue – 10 days – NQF Level 7

In order to qualify for the USAR courses, delegates should be young, fit and intelligent individuals with the following:

- Matric or Grade 12 equivalent
- Basic patient care certificate
- Valid Identity document or passport
- Fire Fighter 1 and 2 – or equivalent

##### Contact Rescue South Africa

Ian Scher – Chief Executive Officer

PO Box 500, Saxonwold, 2132,

Gauteng, South Africa

Tel no: +27 (0)11 234 1545

Mobile: +27 (0)82 459 9765

Email: ian@rescue-sa.co.za

www.rescue-sa.co.za



The Rosenbauer International Group of Companies with its Headquarters in Leonding, Austria, has become the largest exporter of specialty fire fighting vehicles and is today the leading manufacturer in this field.

Founded in 1866, Rosenbauer has become an international group with 13 manufacturing companies (3 in Austria, 2 in Germany, 1 in Russia, 1 in Spain, 3 in USA, 1 in Singapore, 1 in Saudi Arabia, 1 Slovenia). And now from 2018 Rosenbauer South Africa is manufacturing locally in Midrand.

This allows the company to serve the fire services around the world with products conforming to the various kinds of standards (European = EN or American = NFPA).

The fire fighting core components (pumps, foam admixing systems, roof turrets, hose reels etc.) are all designed and manufactured in house to perfectly work as an integrated system for maximum efficiency and operator friendliness.

Latest technologies (FEM calculations and CAD systems) and machinery provide for the industrial quality background for tailor made solutions.

With Metz as part of the Rosenbauer Group, the full range of Turntable Ladders (from 20 to 61m working height) and Hydraulic Platforms (27 - 55 m) is part of the manufacturing program.

Innovative and ergonomic design, latest technology and superior quality are common features throughout the production range of all group companies.

Rosenbauer is proud to be a long term supplier to the South African Fire Community, comprising Civilian and Military Airports, Municipalities, Industry and Navy.

To ensure the local long term service and support of the products, Rosenbauer South Africa is based in Midrand, Gauteng.

Qualified technical experts can handle all routine service through to comprehensive refurbishment jobs in these facilities, as well as manufacturing and assembling.

Furthermore Rosenbauer is offering the full range of Fire & Safety Equipment with exclusive products such as personal protection equipment, the most powerful portable generator available in the market, positive pressure ventilation units, CAFS Trolleys, UHPS systems and a total of more than 3000 fire fighting products etc.

##### Contact: Rosenbauer South Africa

Michael von der Heyde

Mobile: +27 (0)72 925-5959

PO Box 1555 Halfway House 1685

Tel: +27 (0)11 805-7912

Fax: +27 (0)86 511-6082

Email: Rosenbauer.za@rosenbauer.com

www.rosenbauer.com



The Safety First Association was founded in 1932 by Sir Ernest Oppenheimer, the Mayor of Johannesburg and other leading industrialists who felt there was a need to form an association which would concern itself with safety in industry and at the same time promote off-the-job accident prevention and road safety.

The Association is an organisation not for gain whose aim and objective is to promote an awareness of accident situations, road safety and environmental health problems as they exist in day-to-day living among all sectors of the community. This includes the safety of fire fighters both while out on the field, as well as in their fire stations, as well as any manufacturing facility, or office environment.

Road traffic safety is essential for all drivers, be they delivery people or fire fighters driving vehicles to incidents, whether at high speed or not.

This awareness is created mainly through the publication of informative literature.

National Safety & Occupational Hygiene is the Association's official journal and has been published regularly since its inception in 1932. It carries articles on safety, many of which are of relevance to today's fire fighters.

The Safety First Association publishes pocket size cartoon booklets which cover a variety of safety subjects.

Also available from the Safety First Association are various sets of posters which give advice on various safety subjects and which should be on the walls of every manufacturing facility and fire station.

##### Contact The Safety First Association

Tel: +27 (0)11 701-5054

Email: admin@safety1st.co.za

www.safety1st.co.za



SkillsTrain Distribution proudly announces its online, distant learning platforms found on their recently launched website [www.skillstrainlms.co.za](http://www.skillstrainlms.co.za) which offers over 400 courses.

They have signed up with major training material providers with the aim to upskill all participants in an easy to use format.

SkillsTrain Distribution imports and distributes a wide range of training products for niche markets such as health and Safety, Fire and Emergency medical Services, Technical Training, health wellness and life skills.

We specialise in providing services to Treasury, D.O.H. local government, municipal departments, mining, manufacturing and training companies, we currently deal with any specific training need, or assist in specialized libraries for Fire, EMS and educational arenas of expertise, with whatever the client may require to meet their training needs, which may be in the form of text, DVD's, specialized instructor resources for a blended approach, test banks, posters, charts, or an on-line delivery platform to delivery e-learning course content, or simulations.

Skillstrain focuses on local needs but sets global standards and meets them with the right resources. We work exclusively with local producers where we endeavor to market all the training DVDs that have been produced.

SkillsTrain distribution supplies all forms of specialised multi-media training aids such as instructor's resources and student handouts, text and e-options for students, CD ROMs and / or DVD's. We now offer hybrid classroom training solutions.

We exclusively represent Action Training Systems in Vancouver. We are the official importers for IFSTA/FPP, NFPA, Marcom Training Limited, Jones and Bartlett Learning, Lippincott Williams Learning, Elsevier Sciences, Cengage, Wiley, Pearson, McGraw Hill, Management Pocket Books, Emergency Film Group, CI Net incorporating FETN, PSTN. ISTN and EMS television Networks for the e-learning e-commerce platform, amongst others. We collaborate with the best professionals in their respective fields of publishing and producing. Our collaborative partners are carefully selected because of their levels of expertise and knowledge.

##### What's new - [www.skillstrainlms.co.za](http://www.skillstrainlms.co.za)

New to the Skillstrain is the exciting hybrid classroom which is cost-effective and saves time and resources. The new website offers assessments, on-line courses with practical and sign-offs after face to face moderation. Thereafter certification is offered at any one of the accredited training centres county-wide. In this way, learners receive a recognised qualification.

##### Contact Skills Train

Tel: +27 (0)11 467-2730

+27 (0)86 607 7690

Linda Botha

Cell: +27 (0)82 552-7742

Email: linda@skillstrain.co.za

susan@skillstrain.co.za

www.skillstrain.co.za / www.skillstrainlms.co.za



Seventh Wave Investments was established in 2008 in order to save the employees jobs of a failed cut make and trim (CMT) factory.

Seventh Wave specialises in the manufacture of quality reflective high-visibility garments. The garments are made in accordance to the materials and standards set out by the European Standard ISO 20471 (SANS50471 Locally). Seventh wave carries a SABS capability certificate for local manufacture.

Seventh Wave has spent the past two years improving its processes, quality and productivity. The WCM (World Class Manufacturing) method of manufacturing is internationally recognised. This has brought about the introduction of world class standards into the factory. In addition Seventh Wave has invested heavily in new and up to date equipment to improve the quality and processing of garments.

Seventh Wave will customise garments to our client's individual needs, including any printing individualisation required.

Contact Seventh Wave

PO Box 62474 Marshalltown 2107

70 Webber Street Selby Johannesburg

Tel: + 27 (0)11 4937608

Fax: +27 (0)11 4937940



Sparks & Ellis is one of South Africa's leading uniform suppliers and manufacturers. It specialises in complete uniform solutions and offers clients a head-to-toe service.

Developing technologically advanced products, Sparks & Ellis offers uniforms and equipment for security, traffic, fire and rescue, ambulance, law enforcement, and corporate clients.

Sparks and Ellis Uniforms was established in the early 1930s, and bought in 1967 by Cape Union Mart.

It is now owned by Cape Union Mart Group (70%) and empowerment partner, Thebe Investment Corporation (30%) and is one of the few suppliers of uniforms to have a Level 1 BEE rating.

Sparks & Ellis Uniforms has branches in Cape Town, Johannesburg, Durban and Port Elizabeth.

Website: [www.sparks.co.za](http://www.sparks.co.za)

**Contact Sparks & Ellis Uniforms**

*Cape Town (Head Office)*

281 Albert Road,

Woodstock,

Cape Town

Tel: +27 (0)21 404-1240

Email: [info@sparks.co.za](mailto:info@sparks.co.za)

*Johannesburg*

140 Western Service Road,

Woodmead Business Park 2, Woodmead, Johannesburg

Tel: +27 (0)11 262-8906

Email: [info@sparks.co.za](mailto:info@sparks.co.za)

*Durban*

346 Che Guevara (ex Moore) Road,

Glenwood, Durban

Tel: +27 (0)31 202-6660

Email: [info@sparks.co.za](mailto:info@sparks.co.za)

*Port Elizabeth*

64 Martha Str, Kamma Park, Port Elizabeth

Tel: +27 (0)41 379-5390

Email: [info@sparks.co.za](mailto:info@sparks.co.za)

Website: [www.sparks.co.za](http://www.sparks.co.za)



TFM Industries was established in 1966 as a specialist truck customisation, maintenance and repair business.

Today, the TFM Group of Companies is highly respected in South Africa and abroad by its customers in the commercial, municipal, automotive and security sectors.

Supplying specialist truck bodies manufactured and assembled in TFM's Olifantsfontein, East London, and Durban factories, with aftermarket parts, service and maintenance provided nationwide.

TFM is well known for its high-quality and durable product range which includes construction and waste vehicles, cash-in-transit and other armoured vehicles including the latest public order policing vehicles. In addition, TFM build mobile medical clinics and ambulances which cover a wide range of health and emergency medical requirements.

To complement its locally designed and manufactured products TFM have additionally forged many international alliances with industry leaders to support South African market requirements.

In 2017, Kwane Capital led by Mcebisi Mlonzi, acquired a 63.75% stake in the TFM Group increasing the overall black ownership in the group to 88%. The combination of TFM's leading design, engineering, manufacturing and product support capabilities in all sectors, with Kwane, has created a competitive platform to deliver a full service offering of specialist vehicles and maintenance to customers across all sectors.

To this end, and in keeping with the TFM tradition of providing superior products and service to clients, TFM Industries has launched a dedicated Emergency Vehicle Division, focussing on the local manufacture, supply and support of firefighting, rescue and emergency medical vehicles.

In our endeavours to be the #1 service provider in the emergency services industry we subscribe to the following principals:

- Integrity

- Customer focused approach
- Supply of world-class products, exceeding customer expectations
- Provision of unrivalled maintenance and aftersales support

TFM Emergency Vehicles is reporting for duty!

**TFM National Key Manufacturing Facilities include:**

- Olifantsfontein, Gauteng
- Sales Manager: Jaco Keet,
- Mobile: +27 (0)82 450 2256,
- E-mail: [jacok@tfm.co.za](mailto:jacok@tfm.co.za)
- East London, Eastern Cape
- King Williams Town, Eastern Cape
- Durban, KwaZulu Natal



The Rescue Tool Guys (Pty) Ltd was established in the latter part of 2015 to focus solely on all aspects of Holmatro Hydraulic Rescue Tools for the southern African and select African market, hence our slogan "Proudly African ... South African born and bred".

The Rescue Tool Guys (RTG) has the sole agency in South Africa and further afield in Africa for the Holmatro Group in Raamsdonsveer, Holland. Holmatro is the world leader in the design, engineering and supply of hydraulic tools for rescue, industrial and special tactical operations.

RTG was appointed by Holmatro to supply, train and service rescue tools for all the disciplines with regards to fire, rescue, hazmat and disaster management.

RTG is the first international Holmatro dealer to offer the INFINITY WARRANTY, a programme that provides a life time warranty for newly procured products within the terms and conditions of the programme.

Further to this, RTG is one of a few select dealers that has been accredited as a PREMIUM SERVICE CENTRE which is the highest level of service accreditation approved by Holmatro.

For RTG, the supply of rescue tools and related equipment is merely the beginning of the cycle. The company focuses, to the extreme, on training and after sales service, thereby creating a life time relationship with the products that are supplied.

The reference to "Knowledge is Power" is carried in earnest by RTG and is lived in the daily activities of the company. RTG is committed to the transferring of knowledge from the company to the clients in order to empower the end users to utilise the Holmatro products in the execution of their duties in saving lives. This philosophy is achieved through rigorous, constant and internationally recognised training programmes that are offered by the company.

To ensure products are serviced promptly, the company has

well established service and repair centres, as well as excellent mobile-on-site service capabilities with dedicated service vehicles that travel the width and breadth of southern Africa, to deliver a world-class after sales service to all RTG clients.

The Rescue Tool Guys (Pty) Ltd offers the following:

1. Sales and marketing of Holmatro rescue tools
2. Comprehensive training and knowledge transfer on all aspects of hydraulic rescue tool application
3. Mechanical repair of Holmatro rescue tools
4. Maintenance and service of Holmatro rescue tools
5. Application of Infinity Warranty on sale of new products
6. Lease and rental of hydraulic rescue tools

Consulting on all aspects of advanced motor vehicle extrication, new vehicle technology and urban search and rescue techniques using Holmatro Hydraulic Rescue Tools

**Contact The Rescue Tool Guys (Pty) Ltd**

Sales Director - Johan Muller

+ 27 82 609 3438

+ 27 (0)11 823 2481

[johan@trtg.co.za](mailto:johan@trtg.co.za)

Service Director - Romeo Letageng

+ 27 79 880 5251

+ 27 (0)11 823 1927

[romeo@trtg.co.za](mailto:romeo@trtg.co.za)



Sysman is renowned for providing robust, facility-rich and affordable 911 and Disaster Management solutions which it has been doing for the past 34 years.

The effectiveness of an emergency control system is governed by many factors. These include quality and reliable applications all of which must be tightly integrated into one homogeneous system. To this end we offer a portfolio of solutions, some highlights being:

- **ESS:** a web-enabled, 911 call taking and despatching solution, with a real time, electronic video wall, comprehensive reporting, integrated maps with GIS capabilities, Mobile Data Terminal integration, a clean graphical interface and much more.
- **iFIG:** an IP based Station Control system fully integrated with ESS. It offers Bells, PA, Intercom, Bay doors, lights, robots, access control and more.
- **Mobile Data Terminals:** integrated with ESS supporting despatch notes, status updating, on board, voice guided navigation to an incident scene. devices are GPS tracked. Streaming video from an incident scene is also supported. Companion app on devices carried by responders allows for data capture and communications with the control centre and each other without the need for radios.



Vanguard Fire & Safety serves as marketing extension of sister company Industrial Safety Services cc and is positioned as a specialist distributor of leading brand fire-fighting equipment and related industrial safety products.

The products have been well accepted internationally over a number of years, and continue to enjoy considerable success in the local market across a broad range of industries including petro-chemical, mining and municipal fire departments.

Vanguard Fire & Safety is dedicated to the supply of premium quality products to the fire and emergency services related markets, and as a responsible market leader places a significant emphasis on the promotion of legitimate product approvals in the interests of fire-fighter safety.

The products comply with internationally recognised standards including NFPA or the appropriate relevant standard.

Our exclusive product portfolio includes a wide range of fire-fighting apparel and water delivery equipment including branches, monitors, hardware and foam equipment, positive pressure ventilators, and fire-fighting hose.

The extensive product range is distributed nationally through a network of strategic alliances with reputable suppliers who share our vision of maintaining ethical standards in the industry and our passion for fire-fighter safety.

Vanguard Fire & Safety is committed to best total cost solution by offering a product range that represents true value without compromising quality.

**Contact Vanguard Fire & Safety**

John Buchan Tel: +27 (0)31 564 3200

Mobile: +27 (0)82 565-8200

Email: john@isscc.co.za

Stuart Wood Tel: + 27 (0)41 451-2461

Mobile: +27 (0)82 492-9166

Email: stuart@cbsafety.co.za

Email: info@isscc.co.za

www.vanguardfire.co.za

• **Fleet Management:** integrated with ESS. GPS vehicle tracking and vehicle stats and driver behaviour reports such as harsh braking and over speeding. Fuel and Workshop Management Modules also available.

• **WAVE:** a Radio over IP and Voice over IP solution supporting different types of radios on different channels and inter-operability between two or more emergency services. Supports multiple devices including existing radios, laptops and PCs and Smart Phones. Use a smart phone as a radio by pressing a soft PTT button. Widely used by the emergency services, the military and airports throughout the world this solution is has now been installed by Sysman in various sites around South Africa.

• **Disaster Management:** a web enabled, internationally acclaimed Disaster Management system which can be operated from anywhere such as an office, field or JOC centre. It is a unified command system which improves role player coordination, response and information sharing. Departments can plan for events/disasters and the like but can also activate a fast response to unplanned events. The mass communication required during such events/incidents/disasters is a 'must-have' tool for every disaster management organisation. So too is effective feedback from the disaster scene using cellular devices

• **Service Call Management:** an application which enables services calls to be scheduled; allocated to service personnel (each of whom carry a tablet device); for work performed during a service call to be captured and transmitted via the Cloud to the service centre, together with many other facilities that maintains communication with all parties and permits performance monitoring. The software is adaptable to any type of service call.

• **REMRAD:** a completely revised and updated solution that links the fire detection systems in commercial and industrial premises to an emergency monitoring centre. The system can be monitored by up to four emergency centre (typically fire, police, ambulance and security) and supports two-way speech. The new system operates in the cloud using cellular networks. Automatic switching between networks is supported for failsafe and redundancy reasons.

Our 2018/19 portfolio of solutions will impress and may even surprise you. Invite us to talk to you or arrange to visit one of our many installations. You will find us knowledgeable and capable of delivering high quality solutions that will materially assist with your goal of improving service delivery to residents within your area of responsibility.

**Contact Sysman**

Tel: +27(11) 300-3300 or 0861-SYSMAN

Fax: +27(11) 219-7430

Email: sales@sysman.co.za

Web: www.sysman.co.za

# PRODUCT CROSS-INDEX

**4 x 4 WHEEL DRIVE CHASSIS / CABS**

Marcé Fire Fighting Technology  
Rosenbauer  
TFM Industries: Emergency Vehicles

**6 x 6 / 8 x 8 WHEEL DRIVE CHASSIS / CABS**

Marcé Fire Fighting Technology  
Rosenbauer  
TFM Industries: Emergency Vehicles

**10 X 10 WHEEL DRIVE CHASSIS / CABS**

Rosenbauer

**ABSEILING EQUIPMENT**

Fremtac Fire & Rescue  
Marcé Fire Fighting Technology  
Rosenbauer

**ABSORBENTS/BINDERS**

Firebreak  
Marcé Fire Fighting Technology  
Rosenbauer

**ADAPTORS**

DoseTech  
Marcé Fire Fighting Technology  
Rosenbauer

**AERIAL LADDERS**

Marcé Fire Fighting Technology  
Rosenbauer  
TFM Industries: Emergency Vehicles

**AERIAL PLATFORMS**

Marcé Fire Fighting Technology  
Rosenbauer  
TFM Industries: Emergency Vehicles

**AIR COMPRESSORS**

Coltri Compressors  
Divetek Compressors

**AIR LIFTING BAGS**

Fremtac Fire & Rescue  
Hamilton Hydraulic Services  
Holmatro  
Marcé Fire Fighting Technology  
Rosenbauer  
The Rescue Tool Guys

**AIR TENTS**

Fremtac Fire & Rescue  
Hamilton Hydraulic Services  
Marcé Fire Fighting Technology  
Rosenbauer

**AIRCRAFT RESCUE EQUIPMENT**

DoseTech  
Fremtac Fire & Rescue  
Hamilton Hydraulic Services  
Holmatro  
Rosenbauer  
The Rescue Tool Guys

**AIRCRAFT RESCUE VEHICLES**

Marcé Fire Fighting Technology  
Rosenbauer  
TFM Industries: Emergency Vehicles

**ALARMS / WARNING / ALERTING SYSTEMS**

Marcé Fire Fighting Technology  
The Sysman Group

**ALUMINISED SUITS**

Firebreak  
Rosenbauer

**AMBULANCES**

TFM Industries: Emergency Vehicles

**ANT-STATIC CLOTHING**

7th Wave Investments  
Vanguard Fire & Safety

**APPROACH SUITS**

Firebreak  
Rosenbauer

**AUTOMATIC FOAM PROPORTIONERS**

DoseTech  
Fremtac Fire & Rescue  
Godiva  
Marcé Fire Fighting Technology  
Rosenbauer

**AXES**

Fremtac Fire & Rescue  
Hamilton Hydraulic Services  
Marcé Fire Fighting Technology  
Rosenbauer

**BACK PACK PUMPS / SPRAYERS**

Firebreak  
Marcé Fire Fighting Technology  
Rosenbauer

**BAGS - HIGH AND LOW PRESSURE**

Fremtac Fire & Rescue  
Hamilton Hydraulic Services  
Holmatro  
Marcé Fire Fighting Technology  
Rosenbauer  
The Rescue Tool Guys

**BAKKIE UNITS**

Fremtac Fire & Rescue  
Marcé Fire Fighting Technology  
Rosenbauer  
TFM Industries: Emergency Vehicles

**BALANCED FOAM SYSTEMS**

DoseTech  
Fremtac Fire & Rescue  
Godiva  
Rosenbauer

**BALL VALVES**

DoseTech

**BARRIER TAPE / BARRIERS**

Marcé Fire Fighting Technology  
Rosenbauer

**BATTERY OPERATED COMBI TOOL**

Fremtac Fire & Rescue  
Hamilton Hydraulic Services  
Rosenbauer

**BELTS**

Sparks & Ellis

**BLANKETS - FIRE**

Firebreak  
Fremtac Fire & Rescue  
Marcé Fire Fighting Technology  
Rosenbauer

**BOOKS**

Fire Protection Association  
Fremtac Fire & Rescue  
Safety First Association  
Skills Train Distribution

**BOOMS**

Marcé Fire Fighting Technology  
Rosenbauer

**BOOTS**

Dräger South Africa  
Firebreak  
Fremtac Fire & Rescue  
Marcé Fire Fighting Technology  
Rosenbauer  
Sparks & Ellis  
Vanguard Fire & Safety

**BRACKETS FOR VEHICLES**

DoseTech  
Marcé Fire Fighting Technology  
Rosenbauer  
TFM Industries: Emergency Vehicles

**BRANCH PIPES/BRANCHES (FOAM)**

Designation Hose  
DoseTech  
Fremtac Fire & Rescue  
Marcé Fire Fighting Technology  
Rosenbauer  
Vanguard Fire & Safety

**BRANCH REPAIR KITS**

Designation Hose  
DoseTech  
Fremtac Fire & Rescue  
Marcé Fire Fighting Technology  
Rosenbauer  
Vanguard Fire & Safety

**BREATHALISER**

Dräger South Africa  
Firebreak

**BREATHING AIR COMPRESSORS**

Coltri Compressors  
Divetek Compressors  
Dräger South Africa  
Rosenbauer

**BREATHING AIR TEST KIT**

Coltri Compressors  
Dräger South Africa

**BREATHING APPARATUS AND RELATED EQUIPMENT**

Dräger South Africa  
Firebreak  
Fremtac Fire & Rescue  
Marcé Fire Fighting Technology  
Rosenbauer

**BUILDING COLLAPSE STABILISATION**

Fremtac Fire & Rescue  
Hamilton Hydraulic Services  
Holmatro  
Marcé Fire Fighting Technology  
Rosenbauer  
The Rescue Tool Guys

**BUMPER TURRETS / MONITORS**

DoseTech

**BUNKER SUITS**

Dräger South Africa  
DuPont  
Firebreak  
Fremtac Fire & Rescue  
Hamilton Hydraulic Services  
Marcé Fire Fighting Technology  
Rosenbauer  
Vanguard Fire & Safety

**BUSH FIRE COVERALL**

DuPont  
Firebreak  
Marcé Fire Fighting Technology  
Rosenbauer

**BUSH FIRE FIGHTING/RESCUE EQUIPMENT**

Designation Hose  
Fremtac Fire & Rescue  
Godiva  
Hamilton Hydraulic Services  
Marcé Fire Fighting Technology  
Rosenbauer  
Vanguard Fire & Safety

**BUSH PUMPERS**

Marcé Fire Fighting Technology  
Rosenbauer  
TFM Industries: Emergency Vehicles

**CAFS**

Godiva  
Rosenbauer  
TFM Industries: Emergency Vehicles  
Vanguard Fire & Safety

**CAFS STORAGE TANK RIM SEAL PROTECTION**

Fremtac Fire & Rescue

**CALL CENTRES & TRANSFERS**

The Sysman Group

**CALL POINTS**

The Sysman Group

**CAPS & HATS**

7th Wave Investments  
Sparks & Ellis

**CD-ROMS - INFORMATIVE**

Safety First Association  
Skills Train Distribution

**CEILING HOOKS**

Fremtac Fire & Rescue  
Hamilton Hydraulic Services  
Marcé Fire Fighting Technology  
Rosenbauer  
Vanguard Fire & Safety

**CENTRIFUGAL PUMPS - LOW PRESSURE / HIGH PRESSURE / MULTI-STAGE**

DoseTech  
Godiva  
Rosenbauer  
TFM Industries: Emergency Vehicles

**CHARGER - ELECTRICAL**

Rosenbauer

**CHASSIS**

Marcé Fire Fighting Technology  
Rosenbauer  
TFM Industries: Emergency Vehicles

**CHEMICAL ABSORBENTS**

Firebreak  
Marcé Fire Fighting Technology  
Rosenbauer

**CHEMICAL PROTECTION BOOTS**

Dräger South Africa  
Firebreak

**CHEMICAL PROTECTION SUITS**

Dräger South Africa

Download additional copies or past issues of

THE EMERGENCY SERVICES YEARBOOK & BUYER'S GUIDE

from [www.emsguide.co.za](http://www.emsguide.co.za)



DuPont  
Marcé Fire Fighting Technology  
Rosenbauer

**CHEMICAL SPILL SAFETY KITS**  
Firebreak  
Rosenbauer

**CHEMICAL SPILL SEPARATES**  
Rosenbauer

**CHEMICAL SPLASH CLOTHING**  
Dräger South Africa  
DuPont  
Firebreak  
Marcé Fire Fighting Technology  
Rosenbauer

**CLASS A & B FOAM/SYSTEMS**  
Chemsystems  
DoseTech  
Fremtac Fire & Rescue  
Godiva  
Rosenbauer  
TFM Industries: Emergency Vehicles

**CLEANING PROTECTIVE APPAREL / CLOTHING**  
DuPont  
Firebreak

**CLOSED CIRCUIT BREATHING APPARATUS**  
Dräger South Africa  
Fremtac Fire & Rescue  
Marcé Fire Fighting Technology

**COLLECTING BREECHING**  
Designation Hose  
DoseTech  
Fremtac Fire & Rescue  
Marcé Fire Fighting Technology  
Rosenbauer  
Vanguard Fire & Safety

**COMBI TOOLS**  
Fremtac Fire & Rescue  
Hamilton Hydraulic Services  
Holmatro  
Marcé Fire Fighting Technology  
Rosenbauer  
The Rescue Tool Guys

**COMMAND VEHICLES**  
Marcé Fire Fighting Technology  
Rosenbauer  
TFM Industries: Emergency Vehicles

**COMMERCIAL VEHICLES**  
Marcé Fire Fighting Technology  
Rosenbauer  
TFM Industries: Emergency Vehicles

**COMMUNICATIONS**  
Dräger South Africa  
The Sysman Group

**COMPRESSED AIR CYLINDERS**  
Divetek  
Dräger South Africa  
Firebreak  
Fremtac Fire & Rescue

**COMPRESSED AIR FOAM SYSTEMS (CAFS)**  
DoseTech  
Fremtac Fire & Rescue  
Godiva  
Rosenbauer  
TFM Industries: Emergency Vehicles  
Vanguard Fire & Safety

**COMPRESSOR AIR QUALITY**  
Coltri Compressors

Divetek  
Dräger South Africa

**COMPRESSORS - HIGH PRESSURE BREATHING AIR**  
Coltri Compressors  
Divetek  
Dräger South Africa  
Rosenbauer

**CONES - TRAFFIC**  
Firebreak  
Rosenbauer

**CONFINED SPACE EQUIPMENT**  
Dräger South Africa  
Firebreak

Fremtac Fire & Rescue  
Hamilton Hydraulic Services  
Marcé Fire Fighting Technology  
Rosenbauer  
Vanguard Fire & Safety

**CONSOLE FURNITURE**  
The Sysman Group

**CONTROL CENTRES**  
The Sysman Group

**CONTROL PANELS**  
DoseTech  
Marcé Fire Fighting Technology  
Rosenbauer

**COOLING VESTS**  
Dräger South Africa  
Firebreak  
Marcé Fire Fighting Technology  
Rosenbauer  
Vanguard Fire & Safety

**COUPLINGS**  
DoseTech  
Marcé Fire Fighting Technology  
Rosenbauer

**COVERALLS**  
Dräger South Africa  
DuPont  
Firebreak

Marcé Fire Fighting Technology  
Rosenbauer  
Vanguard Fire & Safety

**CRASH AND RESCUE TOOL KIT**  
Fremtac Fire & Rescue  
Hamilton Hydraulic Services  
Marcé Fire Fighting Technology  
Rosenbauer

**CROWD CONTROL**  
DoseTech  
Rosenbauer

**CUTTING BLADES**  
Fremtac Fire & Rescue  
Hamilton Hydraulic Services  
Marcé Fire Fighting Technology  
Rosenbauer  
The Rescue Tool Guys

**CUTTING TOOLS**  
Fremtac Fire & Rescue  
Hamilton Hydraulic Services  
Holmatro  
Marcé Fire Fighting Technology  
Rosenbauer  
Vanguard Fire & Safety

**CYLINDER TESTING AND FILLING**  
Coltri Compressors  
Dräger South Africa  
Firebreak

**DATABASES**  
The Sysman Group

**DECONTAMINATION SHOWERS**  
Firebreak  
Hamilton Hydraulic Services  
Marcé Fire Fighting Technology  
Rosenbauer

**DIGITAL FLOWMETERS**  
DoseTech  
Hamilton Hydraulic Services  
Marcé Fire Fighting Technology  
Rosenbauer  
Vanguard Fire & Safety

**DIGITAL PAGING**  
The Sysman Group

**DIRTY WATER PUMPS**  
Fremtac Fire & Rescue  
Rosenbauer

**DISASTER MANAGEMENT SOFTWARE**  
The Sysman Group

**DISASTER RESPONSE**  
Rescue South Africa

**DISASTER RESPONSE & TRAINING**  
Rescue South Africa

**DISPATCHING SOFTWARE**  
The Sysman Group

**DISTRESS SIGNAL UNITS**  
Dräger South Africa  
Firebreak  
Fremtac Fire & Rescue  
Rosenbauer

**DIVIDING/COLLECTING BREECHINGS**  
Designation Hose  
DoseTech  
Fremtac Fire & Rescue  
Marcé Fire Fighting Technology  
Rosenbauer

**DIVING EQUIPMENT**  
Coltri Compressors  
Divetek  
Dräger South Africa  
Fremtac Fire & Rescue  
Rosenbauer

**DOOR RAM**  
Fremtac Fire & Rescue  
Hamilton Hydraulic Services  
Marcé Fire Fighting Technology  
Rosenbauer

**DRAIN PROTECTION KITS**  
Rosenbauer

**DRUG BAGS**  
Firebreak

**DRUG TEST EQUIPMENT**  
Dräger South Africa  
Firebreak

**DRY POWDER**  
Firebreak  
Rosenbauer

**DUST MASKS**  
Dräger South Africa  
Firebreak  
Rosenbauer

**EMERGENCY AIR HORNS**  
Firebreak  
Rosenbauer

**EMERGENCY LIGHTING**  
Firebreak  
Hamilton Hydraulic Services  
Marcé Fire Fighting Technology  
Rosenbauer  
Unqondo Projects

**EMERGENCY RESPONSE SERVICES**  
ETS Emergency Training Solutions  
Rescue South Africa

**EMERGENCY SHELTERS**  
Hamilton Hydraulic Services

**EMERGENCY SPILL KITS**  
Firebreak  
Marcé Fire Fighting Technology  
Rosenbauer

**EMERGENCY TENDERS/ VEHICLES**  
Marcé Fire Fighting Technology  
Rosenbauer  
TFM Industries: Emergency Vehicles

**ENGINE & FUEL PRE-HEATERS**  
Rosenbauer

**ENTRY CONTROL BOARDS**  
Dräger South Africa

**EPAULETTES & BADGES**  
Sparks & Ellis

**ESCAPE CHUTES**  
Rosenbauer

**ESCAPE SETS**  
Dräger South Africa  
Firebreak  
Fremtac Fire & Rescue  
Rosenbauer

**EXPLOSIMETERS**  
Dräger South Africa  
Firebreak  
Marcé Fire Fighting Technology  
Rosenbauer

**EXTRICATION DEVICES**  
Fremtac Fire & Rescue  
Hamilton Hydraulic Services  
Holmatro  
The Rescue Tool Guys

**EYEWEAR**  
Dräger South Africa  
Firebreak  
Fremtac Fire & Rescue  
Rosenbauer  
Vanguard Fire & Safety

**FACE PROTECTION**  
Dräger South Africa  
Firebreak  
Rosenbauer  
Vanguard Fire & Safety

**FALL PREVENTION EQUIPMENT**  
Fremtac Fire & Rescue  
Rosenbauer

**FILTER CARTRIDGES**  
Dräger South Africa  
Firebreak  
Fremtac Fire & Rescue  
Rosenbauer

**FIRE BEATERS**  
Firebreak  
Marcé Fire Fighting Technology  
Rosenbauer

**FIRE ESCAPE HOODS**  
Dräger South Africa  
Firebreak  
Fremtac Fire & Rescue  
Marcé Fire Fighting Technology  
Rosenbauer

**FIRE FIGHTING FOAM**  
Chemsystems  
DoseTech  
Firebreak  
Fremtac Fire & Rescue  
Marcé Fire Fighting Technology  
Rosenbauer

**FIRE FIGHTING FOAM TRAILERS**  
DoseTech

**FIRE FIGHTING/PREVENTION TRAINING**  
ETS Emergency Training Solutions  
Fire Protection Association of Southern Africa

**FIRE FIGHTING TRAILER PUMPS**  
DoseTech  
Fremtac Fire & Rescue  
Godiva  
Marcé Fire Fighting Technology  
Rosenbauer  
TFM Industries: Emergency Vehicles

**FIRE FIGHTING VEHICLES**  
Fremtac Fire & Rescue  
Marcé Fire Fighting Technology  
Rosenbauer  
TFM Industries: Emergency Vehicles

**FIRE HOSE**  
Designation Hose  
Firebreak  
Fremtac Fire & Rescue  
Marcé Fire Fighting Technology  
Rosenbauer  
Unqondo Projects  
Vanguard Fire & Safety

**FIRE HYDRANTS**  
DoseTech  
Fremtac Fire & Rescue

**FIRE PROXIMITY SUITS**  
Firebreak  
Rosenbauer  
Vanguard Fire & Safety

**FIRE RESISTANT COVERALLS**  
DuPont  
Firebreak  
Marcé Fire Fighting Technology  
Rosenbauer  
Vanguard Fire & Safety

**FIRE RETARDANTS**  
Chemsystems  
DoseTech  
Fremtac Fire & Rescue  
Rosenbauer

**FIRE STATION EQUIPMENT**  
DoseTech  
Marcé Fire Fighting Technology  
Rosenbauer

**FIRE SUPPRESSION SYSTEMS**  
DoseTech  
Rosenbauer

**FIRE TENDERS**  
Marcé Fire Fighting Technology  
Rosenbauer  
TFM Industries: Emergency Vehicles

**FIRE TROLLEYS**  
DoseTech  
Marcé Fire Fighting Technology  
Rosenbauer  
TFM Industries: Emergency Vehicles

**FIRST AID KITS & EQUIPMENT**  
Firebreak  
Marcé Fire Fighting Technology  
Rosenbauer

**FIRST AID TRAINING**  
ETS Emergency Training Solutions

**FITTINGS AND ACCESSORIES**  
Marcé Fire Fighting Technology  
Rosenbauer

**FIXED GAS MONITORING**  
Dräger South Africa

**FLAME RESISTANT CLOTHING**  
DuPont  
Firebreak  
7th Wave Investments  
Rosenbauer

**FLASH LIGHTS**  
Firebreak  
Marcé Fire Fighting Technology  
Rosenbauer  
Sparks & Ellis  
Vanguard Fire & Safety

**FLASHLIGHTS UNDERWATER**  
Divetek

**FLOATING PUMPS**  
Fremtac Fire & Rescue  
Godiva  
Marcé Fire Fighting Technology  
Rosenbauer  
TFM Industries: Emergency Vehicles

**FLOOD LIGHTING SYSTEMS**  
Marcé Fire Fighting Technology  
Rosenbauer

**FLOW INDICATORS**  
DoseTech  
Marcé Fire Fighting Technology  
Rosenbauer  
Vanguard Fire & Safety

**FLOW & PRESSURE METERS**  
DoseTech  
Godiva  
Hamilton Hydraulic Services  
Marcé Fire Fighting Technology  
Rosenbauer  
Vanguard Fire & Safety

**FOAM COMPOUNDS / CONCENTRATES**  
Chemsystems  
DoseTech  
Firebreak  
Fremtac Fire & Rescue  
Marcé Fire Fighting Technology  
Rosenbauer

**FOAM DELIVERY SYSTEMS**  
DoseTech  
Godiva  
Fremtac Fire & Rescue  
Unqondo Projects  
Vanguard Fire & Safety

**FOAM DOSING NOZZLES**  
DoseTech

**FOAM EQUIPMENT**  
Designation Hose  
DoseTech  
Firebreak  
Fremtac Fire & Rescue  
Godiva  
Marcé Fire Fighting Technology  
Rosenbauer  
Vanguard Fire & Safety

**FOAM MAKING ACCESSORIES**  
DoseTech  
Firebreak  
Fremtac Fire & Rescue  
Godiva  
Marcé Fire Fighting Technology  
Rosenbauer

**FOAM MAKING BRANCH-PIPES**  
Designation Hose  
DoseTech  
Firebreak  
Fremtac Fire & Rescue  
Marcé Fire Fighting Technology  
Rosenbauer  
Vanguard Fire & Safety

**FOAM NOZZLES**  
Designation Hose  
DoseTech  
Firebreak  
Fremtac Fire & Rescue  
Marcé Fire Fighting Technology  
Rosenbauer  
Vanguard Fire & Safety

**FOAM POURERS**  
DoseTech

**FOAM PRODUCTS - ENTERTAINMENT INDUSTRY**  
DoseTech  
Godiva

**FOAM PROPORTIONING SYSTEMS**  
DoseTech  
Godiva  
Rosenbauer

**FOAM PUMPS**  
DoseTech  
Godiva  
Marcé Fire Fighting Technology  
Rosenbauer  
TFM Industries: Emergency Vehicles

**FOAM TOWER**  
DoseTech  
Rosenbauer

**FOAM TRAILERS**  
DoseTech  
Fremtac Fire & Rescue  
Rosenbauer  
TFM Industries: Emergency Vehicles

**FOAM TUBES - LOW & MEDIUM**  
DoseTech

**FOAM UNITS - MOBILE**  
DoseTech  
Fremtac Fire & Rescue  
Godiva  
Marcé Fire Fighting Technology  
Rosenbauer  
TFM Industries: Emergency Vehicles

**FOG GUNS**  
DoseTech

Fremtac Fire & Rescue  
Marcé Fire Fighting Technology  
Rosenbauer

**FOG / STREAM NOZZLES**  
DoseTech

**FOOTWEAR**  
Firebreak  
Fremtac Fire & Rescue  
Rosenbauer  
Sparks & Ellis  
Vanguard Fire & Safety

**FORCIBLE ENTRY TOOLS**  
Fremtac Fire & Rescue  
Holmatro  
Marcé Fire Fighting Technology  
Rosenbauer  
The Rescue Tool Guys

**FORESTRY CLOTHING**  
Vanguard Fire & Safety

**FORESTRY VEHICLES**  
Marcé Fire Fighting Technology  
Rosenbauer  
TFM Industries: Emergency Vehicles

**FORESTRY SKIDS**  
Marcé Fire Fighting Technology  
Rosenbauer  
TFM Industries: Emergency Vehicles

**GAS ANALYSERS / INDICATORS**  
Dräger South Africa  
Firebreak

**GAS CANISTERS**  
Dräger South Africa  
Firebreak

**GAS DETECTORS / MONITORS**  
Dräger South Africa  
Firebreak  
Fremtac Fire & Rescue  
Marcé Fire Fighting Technology  
Rosenbauer

**GAS DETECTOR HAZMAT SUIT**  
Dräger South Africa  
Firebreak  
Rosenbauer

**GAS MASKS**  
Dräger South Africa  
Firebreak  
Rosenbauer

**GAS PROTECTION SUITS**  
Dräger South Africa  
Firebreak  
Rosenbauer

**GAUGES**  
Godiva  
Rosenbauer

**GEAR LEVERS**  
Vanguard Fire & Safety

**GENERATORS**  
Rosenbauer

**GLOVES**  
Firebreak  
Fremtac Fire & Rescue  
Marcé Fire Fighting Technology  
Rosenbauer  
Unqondo Projects  
Vanguard Fire & Safety

**GOLF CAR CONVERSIONS**  
Marcé Fire Fighting Technology  
TFM Industries: Emergency Vehicles

**GRASS FIRE PUMPER**  
Marcé Fire Fighting Technology  
Rosenbauer  
TFM Industries: Emergency Vehicles

**GRASS FIRE SKID UNITS**  
TFM Industries: Emergency Vehicles

**GRASS FIRE SUITS**  
Marcé Fire Fighting Technology  
Rosenbauer  
Vanguard Fire & Safety

**GROUND LADDER SERVICE,  
REPAIR AND LOAD TESTING**  
Fremtac Fire & Rescue

**HAND EXTINGUISHING  
EQUIPMENT**  
Firebreak  
Fremtac Fire & Rescue  
Marcé Fire Fighting Technology  
Rosenbauer

**HAND PROTECTION**  
Firebreak  
Fremtac Fire & Rescue  
Marcé Fire Fighting Technology  
Rosenbauer  
Vanguard Fire & Safety

**HARNESSES**  
Firebreak  
Fremtac Fire & Rescue  
Rosenbauer

**HAZCHEM LABELLING**  
Firebreak

**HAZMAT ABSORBENTS**  
Firebreak  
Marcé Fire Fighting Technology  
Rosenbauer

**HAZMAT EQUIPMENT**  
Dräger South Africa  
Firebreak  
Marcé Fire Fighting Technology  
Rosenbauer

**HAZMAT KITS**  
Dräger South Africa  
Firebreak  
Rosenbauer

**HAZMAT SUITS**  
Dräger South Africa  
DuPont  
Marcé Fire Fighting Technology  
Rosenbauer  
Vanguard Fire & Safety

**HEAT PROTECTION SUITS**  
DuPont  
Firebreak  
Rosenbauer  
Vanguard Fire & Safety

**HEAVY DUTY RESCUE PUMPER**  
Marcé Fire Fighting Technology  
Rosenbauer  
TFM Industries: Emergency Vehicles

**HELMET LIGHTS**  
Dräger South Africa  
Firebreak  
Marcé Fire Fighting Technology  
Rosenbauer  
Vanguard Fire & Safety

**HELMETS**  
Dräger South Africa  
Firebreak  
Fremtac Fire & Rescue  
Marcé Fire Fighting Technology  
Rosenbauer  
Vanguard Fire & Safety

**HIGH EXPANSION BUND  
POURERS**  
DoseTech

**HIGH PRESSURE BREATHING  
AIR AND INDUSTRIAL  
COMPRESSORS**  
Coltri Compressors

**HIGH PRESSURE EXTERNAL  
PIPE SEALERS**  
Hamilton Hydraulic Services

**HIGH PRESSURE GAS AND  
LIQUID BOOST**  
Divetek Compressors

**HIGH PRESSURE PUMP  
SYSTEMS**  
Godiva  
Holmatro  
Marcé Fire Fighting Technology  
Rosenbauer  
TFM Industries: Emergency Vehicles  
The Rescue Tool Guys

**HIGH PRESSURE RESCUE BAGS**  
Fremtac Fire & Rescue  
Hamilton Hydraulic Services  
Holmatro  
Marcé Fire Fighting Technology  
Rosenbauer  
The Rescue Tool Guys

**HIGH PRESSURE VALVES**  
Divetek Compressors  
DoseTech  
Dräger South Africa  
Rosenbauer

**HIGH SPEED CUTTERS**  
Fremtac Fire & Rescue  
Hamilton Hydraulic Services  
Holmatro  
Rosenbauer  
The Rescue Tool Guys

**HIGH VOLUME MONITORS**  
DoseTech

**HIGH VOLUME WATER SYSTEMS**  
DoseTech  
Fremtac Fire & Rescue  
Godiva  
Vanguard Fire & Safety

**HI-VIZ CLOTHING**  
7th Wave Investments  
Rosenbauer  
Sparks & Ellis

**HOISTS**  
Fremtac Fire & Rescue

**HOODS**  
Dräger South Africa  
Fremtac Fire & Rescue  
Marcé Fire Fighting Technology  
Rosenbauer  
Vanguard Fire & Safety

**HOSE CARRIERS**  
Marcé Fire Fighting Technology  
Rosenbauer  
TFM Industries: Emergency Vehicles  
Vanguard Fire & Safety

**HOSE COUPLINGS**  
DoseTech  
Fremtac Fire & Rescue  
Holmatro  
Marcé Fire Fighting Technology  
Rosenbauer  
The Rescue Tool Guys

**HOSES - FIRE**  
Designation Hose  
Firebreak  
Fremtac Fire & Rescue  
Marcé Fire Fighting Technology  
Rosenbauer  
Vanguard Fire & Safety

**HOSE PATCHES**  
Fremtac Fire & Rescue  
Rosenbauer  
Vanguard Fire & Safety

**HOSE RAMPS**  
Fremtac Fire & Rescue  
Rosenbauer

**HOSE REELS/UNITS**  
Holmatro  
Marcé Fire Fighting Technology  
Rosenbauer  
The Rescue Tool Guys

**HYDRANTS**  
DoseTech  
Fremtac Fire & Rescue

**HYDRAULIC PLATFORMS**  
Marcé Fire Fighting Technology  
Rosenbauer  
TFM Industries: Emergency Vehicles

**HYDRAULIC RESCUE EQUIPMENT**  
Fremtac Fire & Rescue  
Hamilton Hydraulic Services  
Holmatro  
Marcé Fire Fighting Technology  
Rosenbauer  
The Rescue Tool Guys

**INCIDENT COMMAND  
RESPONSE**  
Rosenbauer  
The Sysman Group

**INDUSTRIAL FIRE FIGHTING  
VEHICLES**  
DoseTech  
Marcé Fire Fighting Technology  
Rosenbauer  
TFM Industries: Emergency Vehicles

**INDUSTRIAL FOAM NOZZLES**  
DoseTech  
Fremtac Fire & Rescue

**INDUSTRIAL TRAILER UNITS**  
DoseTech  
Fremtac Fire & Rescue  
Godiva  
Marcé Fire Fighting Technology  
Rosenbauer

**INFLATABLE LIGHTS**  
Marcé Fire Fighting Technology  
Rosenbauer

**INFLATABLE PIPE SEALERS**  
Hamilton Hydraulic Services  
Rosenbauer

**INFLATABLE TENTS & SHELTERS**  
Fremtac Fire & Rescue  
Hamilton Hydraulic Services  
Rosenbauer

**INFLATABLE WALKWAYS**  
Hamilton Hydraulic Services

**INFLATABLE WATER  
CONTAINERS**  
Hamilton Hydraulic Services  
Rosenbauer

**INTAKE VALVES**  
DoseTech

**JACKETS**  
Firebreak  
7th Wave Investments  
Rosenbauer  
Sparks & Ellis  
Vanguard Fire & Safety

**JERSEYS**  
Sparks & Ellis

**KNAPSACK PUMPS**  
Designation Hose  
Fremtac Fire & Rescue  
Marcé Fire Fighting Technology  
Rosenbauer

**LADDERS**  
Fremtac Fire & Rescue  
Marcé Fire Fighting Technology  
Rosenbauer

**LAMPS**  
Firebreak  
Rosenbauer  
Unqondo Projects  
Vanguard Fire & Safety

**LEAK DETECTION INSTRUMENTS**  
Dräger South Africa  
Marcé Fire Fighting Technology  
Rosenbauer

**LEAK SEALING EQUIPMENT**  
Hamilton Hydraulic Services  
Holmatro  
Marcé Fire Fighting Technology  
Rosenbauer

**LIFE RINGS**  
Firebreak  
Fremtac Fire & Rescue

**LIFTING BAGS**  
Fremtac Fire & Rescue  
Hamilton Hydraulic Services  
Holmatro  
Marcé Fire Fighting Technology  
Rosenbauer  
The Rescue Tool Guys  
Vanguard Fire and Safety

**LIGHTING**  
DoseTech  
Firebreak  
Marcé Fire Fighting Technology  
Rosenbauer

**LINE DEPLOYMENT KITS**  
Fremtac Fire & Rescue

**LOCK-OUT STATION**  
Firebreak

**MANAGEMENT SOLUTIONS**  
ETS Emergency Training Solutions

**MAPPING/GIS**  
The Sysman Group

**MARINE FIRE FIGHTING FOAMS**  
Chemsystems  
DoseTech  
Fremtac Fire & Rescue

**MARINE RESCUE**  
Holmatro  
The Rescue Tool Guys

**MASKS AND FILTERS**  
Dräger South Africa  
Firebreak  
Fremtac Fire & Rescue  
Rosenbauer

**MATTRESSES - VACUUM**  
Rosenbauer

**MECHANICAL FLOW METERS**  
DoseTech

**MEDICAL EQUIPMENT**  
Marcé Fire Fighting Technology  
Rosenbauer

**MEDICAL/PARAMEDIC TRAINING**  
ETS Emergency Training Solutions

**METHANOMETERS**  
Firebreak  
Dräger South Africa

**MINI PUMPER**  
Marcé Fire Fighting Technology  
Rosenbauer  
TFM Industries: Emergency Vehicles

**MOBILE COMMUNICATIONS**  
Dräger South Africa

**MOBILE FOAM UNITS**  
DoseTech  
Fremtac Fire & Rescue  
Godiva  
Marcé Fire Fighting Technology  
Rosenbauer  
TFM Industries: Emergency Vehicles

**MOBILE PUMPS**  
Fremtac Fire & Rescue  
Godiva  
Holmatro  
The Rescue Tool Guys

**MONITORS - FIRE**  
Designation Hose  
DoseTech  
Dräger South Africa  
Fremtac Fire & Rescue  
Marcé Fire Fighting Technology  
Rosenbauer  
Vanguard Fire & Safety

**MOUNTING BRACKETS**  
Rosenbauer

**NOZZLES**  
Designation Hose  
DoseTech  
Fremtac Fire & Rescue  
Marcé Fire Fighting Technology  
Rosenbauer  
Vanguard Fire & Safety

**NOZZLE REPAIR KITS**  
Designation Hose  
DoseTech  
Fremtac Fire & Rescue  
Marcé Fire Fighting Technology  
Rosenbauer  
Vanguard Fire & Safety

**NOZZLE REPAIR KITS**  
Designation Hose  
DoseTech  
Fremtac Fire & Rescue  
Marcé Fire Fighting Technology  
Rosenbauer  
Vanguard Fire & Safety

**OCCUPATIONAL SAFETY  
TRAINING**  
ETS Emergency Training Solutions

**OIL ABSORBENTS**  
Firebreak  
Marcé Fire Fighting Technology  
Rosenbauer

**OVERALLS**  
DuPont  
Firebreak  
Rosenbauer  
Sparks & Ellis  
Vanguard Fire & Safety

**OVER TROUSERS**  
Marcé Fire Fighting Technology

**OXYGEN BOOSTERS**  
Coltri Compressors  
Dräger South Africa

**OXYGEN CYLINDERS**  
Divetek

**OXYGEN INDICATORS**  
Dräger South Africa  
Firebreak

**PARAMEDIC BAGS / KITS**  
Fremtac Fire & Rescue  
Rosenbauer

**PETROL/DIESEL DRIVEN PUMPS**  
DoseTech  
Fremtac Fire & Rescue  
Holmatro

**PIPE SEALERS**  
Hamilton Hydraulic Services

**PORTABLE ALARMS**  
DoseTech  
Dräger South Africa  
Firebreak  
Godiva

**PORTABLE COMPRESSORS**  
Coltri Compressors  
Dräger South Africa  
Rosenbauer

**PORTABLE MONITORS**  
DoseTech

**PORTABLE PUMPS**  
Fremtac Fire & Rescue  
Holmatro  
Marcé Fire Fighting Technology  
Rosenbauer  
TFM Industries: Emergency Vehicles

**PORTABLE SCENE LIGHTS**  
DoseTech

**POSITIVE PRESSURE  
VENTILATORS (PPV)**  
Fremtac Fire & Rescue  
Hamilton Hydraulic Services  
Marcé Fire Fighting Technology  
Rosenbauer  
Vanguard Fire & Safety

**POSTERS**  
Safety First Association  
Skills Train Distribution

**POWER CUTTERS**  
Fremtac Fire & Rescue  
Hamilton Hydraulic Services  
Holmatro

Marcé Fire Fighting Technology  
Rosenbauer  
The Rescue Tool Guys

**POWER TOOLS /UNITS**  
Fremtac Fire & Rescue  
Hamilton Hydraulic Services  
Holmatro  
Marcé Fire Fighting Technology  
Rosenbauer  
The Rescue Tool Guys

**PRESSURE BREATHING AIR**  
Coltri Compressors  
Divetek Compressors

**PRESSURE FOAM  
PROPORTIONERS**  
DoseTech  
Godiva  
Marcé Fire Fighting Technology  
Rosenbauer

**PROTECTIVE CLOTHING**  
Dräger South Africa  
DuPont  
Firebreak  
Marcé Fire Fighting Technology  
7th Wave Investments  
Rosenbauer  
Vanguard Fire & Safety

**PROXIMITY SUITS**  
Firebreak  
Rosenbauer  
Vanguard Fire & Safety

**PUBLICATIONS**  
Delinds Publications cc  
Holmatro  
Fire Protection Association of  
Southern Africa  
Safety First Association  
Skills Train Distribution  
The Rescue Tool Guys

**PUMP WATER TANKERS**  
Marcé Fire Fighting Technology  
Rosenbauer  
TFM Industries: Emergency Vehicles

**PUMPER**  
Marcé Fire Fighting Technology  
Rosenbauer  
TFM Industries: Emergency Vehicles

**PUMPS (EFFLUENT)**  
Rosenbauer

**PUMPS (FIRE FIGHTING & HIGH  
PRESSURE)**  
DoseTech  
Fremtac Fire & Rescue  
Godiva  
Holmatro  
Marcé Fire Fighting Technology  
Rosenbauer  
The Rescue Tool Guys

**PUMPS (PORTABLE FLOATING)**  
Fremtac Fire & Rescue  
Godiva  
Marcé Fire Fighting Technology  
Rosenbauer  
TFM Industries: Emergency Vehicles

**PUMPS (DIRTY WATER  
PORTABLE)**  
Fremtac Fire & Rescue  
Godiva  
Rosenbauer

**PUMPS (VEHICLE MOUNT)**  
Godiva  
Hamilton Hydraulic Services  
Holmatro  
Marcé Fire Fighting Technology  
Rosenbauer  
TFM Industries: Emergency Vehicles  
The Rescue Tool Guys

**RADIO SWITCHING**  
The Sysman Group

**RAINWEAR**  
7th Wave Investments

**RAPID RESPONSE VEHICLES**  
DoseTech  
Marcé Fire Fighting Technology  
Rosenbauer  
TFM Industries: Emergency Vehicles

**RAMS**  
Fremtac Fire & Rescue  
Hamilton Hydraulic Services  
Holmatro  
Marcé Fire Fighting Technology  
Rosenbauer  
The Rescue Tool Guys

**RECIPROCATING SAWS/BLADES**  
Fremtac Fire & Rescue  
Hamilton Hydraulic Services  
Rosenbauer

**REFLECTIVE TAPE**  
Firebreak  
7th Wave Investments

**REFLECTIVE WEAR**  
7th Wave Investments  
Rosenbauer

**REFURBISHED VEHICLES**  
Marcé Fire Fighting Technology  
TFM Industries: Emergency Vehicles

**REMOTE AREA LIGHTING**  
Hamilton Hydraulic Services

**REMOTE CONTROL MONITORS**  
DoseTech

**RESCUE BAGS**  
Fremtac Fire & Rescue  
Hamilton Hydraulic Services  
Marcé Fire Fighting Technology  
Rosenbauer

**RESCUE EQUIPMENT**  
Fremtac Fire & Rescue  
Hamilton Hydraulic Services  
Holmatro  
Marcé Fire Fighting Technology  
Rosenbauer  
The Rescue Tool Guys

**RESCUE EQUIPMENT SERVICE  
& REPAIR**  
Fremtac Fire & Rescue  
Hamilton Hydraulic Services  
Holmatro  
Rosenbauer  
The Rescue Tool Guys

**RESCUE PUMPER**  
Marcé Fire Fighting Technology  
Rosenbauer  
TFM Industries: Emergency Vehicles

**RESCUE SAWS**  
Fremtac Fire & Rescue  
Hamilton Hydraulic Services  
Marcé Fire Fighting Technology  
Rosenbauer

**RESCUE STRETCHERS**  
Firebreak  
Fremtac Fire & Rescue  
Rosenbauer

**RESCUE STRUTS**  
Fremtac Fire & Rescue  
Hamilton Hydraulic Services  
Holmatro  
Marcé Fire Fighting Technology  
The Rescue Tool Guys

**RESCUE TOOLS**  
Fremtac Fire & Rescue  
Hamilton Hydraulic Services  
Holmatro  
Marcé Fire Fighting Technology  
Rosenbauer  
The Rescue Tool Guys

**RESCUE TRAINING**  
ETS Emergency Training Solutions  
Fire Protection Association of  
Southern Africa  
Holmatro  
Rescue South Africa  
The Rescue Tool Guys

**RESCUE VEHICLES**  
Marcé Fire Fighting Technology  
Rosenbauer  
TFM Industries: Emergency Vehicles

**RESPIRATORY PROTECTION**  
Dräger South Africa  
Firebreak

**RESPONDER PUMPER**  
Marcé Fire Fighting Technology  
Rosenbauer  
TFM Industries: Emergency Vehicles

**RISK ASSESSMENTS**  
Fire Protection Association of  
Southern Africa

**ROAD CONES**  
Firebreak  
Rosenbauer

**ROAD SAFETY**  
7th Wave Investments

**ROLLER SHUTTER DOORS**  
Marcé Fire Fighting Technology  
Rosenbauer  
TFM Industries: Emergency Vehicles

**ROOF TURRETS / MONITORS**  
DoseTech

**ROPE ACCESS**  
Fremtac Fire & Rescue  
Marcé Fire Fighting Technology  
Rosenbauer

**ROPES**  
Fremtac Fire & Rescue  
Marcé Fire Fighting Technology

**SAFETY LIGHTING**  
DoseTech  
Marcé Fire Fighting Technology  
Rosenbauer

**SALVAGE SHEETS**  
Hamilton Hydraulic Services  
Marcé Fire Fighting Technology  
Rosenbauer

**SAWS / BLADES**  
Fremtac Fire & Rescue  
Hamilton Hydraulic Services

Marcé Fire Fighting Technology  
Rosenbauer

**SELF RESCUERS**  
Dräger South Africa  
Fremtac Fire & Rescue

**SHIRTS**  
Sparks & Ellis

**SHORING SYSTEMS**  
Fremtac Fire & Rescue  
Hamilton Hydraulic Services  
Holmatro  
The Rescue Tool Guys

**SHOWERS - DECONTAMINATION**  
Firebreak  
Hamilton Hydraulic Services  
Marcé Fire Fighting Technology  
Rosenbauer

**SIGNAGE**  
Firebreak  
TFM Industries: Emergency Vehicles

**SKYLIFTS**  
Rosenbauer  
TFM Industries: Emergency Vehicles

**SMALL RESCUE VEHICLES**  
Marcé Fire Fighting Technology  
Rosenbauer  
TFM Industries: Emergency Vehicles

**SOCKS**  
Sparks & Ellis  
Vanguard Fire & Safety

**SOFTWARE**  
Holmatro  
Skills Train Distribution  
The Rescue Tool Guys  
The Sysman Group

**SOLID STREAM NOZZLES**  
DoseTech

**SPECIALISED RESCUE UNITS**  
Fremtac Fire & Rescue  
Rosenbauer  
TFM Industries: Emergency Vehicles

**SPECIALISED VEHICLES**  
Marcé Fire Fighting Technology  
Rosenbauer  
TFM Industries: Emergency Vehicles

**SPILL RESPONSE KITS**  
Firebreak  
Rosenbauer

**SPILL RESPONSE VEHICLES / TRAILERS**  
Rosenbauer

**SPINE BOARDS**  
Fremtac Fire & Rescue  
Rosenbauer

**SPOTLIGHTS**  
Firebreak

**SPREADERS**  
Fremtac Fire & Rescue  
Hamilton Hydraulic Services  
Holmatro  
Marcé Fire Fighting Technology  
Rosenbauer  
The Rescue Tool Guys

**SQUATTER SHACK TROLLEYS**  
Marcé Fire Fighting Technology

**STACK GAS ANALYSERS**  
Dräger South Africa

**STANDPIPES**  
Designation Hose  
Fremtac Fire & Rescue  
Rosenbauer

**STATION CONTROL SOFTWARE**  
The Sysman Group

**STATION WEAR**  
Sparks & Ellis

**STORAGE TANKS**  
Hamilton Hydraulic Services  
Rosenbauer

**STRETCHERS**  
Firebreak  
Rosenbauer

**SUCTION HOSES**  
Designation Hose  
Marcé Fire Fighting Technology  
Rosenbauer  
Vanguard Fire & Safety

**SUCTION STRAINERS**  
DoseTech  
Rosenbauer

**SWIFT WATER RESCUE EQUIPMENT**  
Fremtac Fire & Rescue

**SWING OUT VALVES & SERVICE KITS**  
DoseTech

**TANK LEVEL GAUGES**  
Rosenbauer  
TFM Industries: Emergency Vehicles

**TANK PUMPS - PORTABLE**  
Godiva  
Rosenbauer  
TFM Industries: Emergency Vehicles

**TANK SEALING SYSTEMS**  
Hamilton Hydraulic Services  
Rosenbauer

**TANK TOP POURERS**  
DoseTech

**TEMPERATURE MEASURING KITS**  
Fremtac Fire & Rescue  
Marcé Fire Fighting Technology  
Rosenbauer

**THERMAL DETECTORS**  
Fremtac Fire & Rescue  
Marcé Fire Fighting Technology  
Rosenbauer  
Vanguard Fire & Safety

**THERMAL IMAGING CAMERAS**  
Dräger South Africa  
Firebreak  
Fremtac Fire & Rescue  
Marcé Fire Fighting Technology  
Rosenbauer  
Vanguard Fire & Safety

**TOOLS - HAZMAT**  
Marcé Fire Fighting Technology  
Rosenbauer

**TORCHES**  
Firebreak  
Hamilton Hydraulic Services  
Marcé Fire Fighting Technology

Rosenbauer  
7th Wave Investments  
Sparks & Ellis  
Vanguard Fire & Safety

**TOXIC GAS MONITORS**  
Dräger South Africa  
Fremtac Fire & Rescue  
Rosenbauer

**TRAFFIC CONTROL**  
Marcé Fire Fighting Technology  
7th Wave Investments

**TRAILERS - FOAM / FIRE FIGHTING / HAZMAT / DISASTER**  
DoseTech  
Godiva  
Rosenbauer  
TFM Industries: Emergency Vehicles

**TRAILERS RESCUE**  
Godiva  
Rosenbauer  
TFM Industries: Emergency Vehicles

**TRAIN RESCUE EQUIPMENT**  
Fremtac Fire & Rescue  
Hamilton Hydraulic Services  
Holmatro  
The Rescue Tool Guys

**TRAINING**  
Coltri Compressors  
DuPont  
ETS Emergency Training Solutions  
Fire Protection Association of  
Southern Africa  
Fremtac Fire and Rescue  
Rescue South Africa  
Rosenbauer  
The Rescue Tool Guys

**TRAINING MATERIALS / KITS**  
DuPont  
Holmatro  
Safety First Association  
Skills Train Distribution  
The Rescue Tool Guys

**TRENCH RESCUE EQUIPMENT**  
Fremtac Fire & Rescue  
Hamilton Hydraulic Services  
Holmatro  
The Rescue Tool Guys

**TUNICS**  
DuPont  
Marcé Fire Fighting Technology  
Rosenbauer  
Sparks & Ellis  
Vanguard Fire & Safety

**TURNTABLE LADDERS**  
Marcé Fire Fighting Technology  
Rosenbauer  
TFM Industries: Emergency Vehicles

**TURRETS / MONITORS**  
DoseTech

**TWIN BLADE RESCUE SAWS**  
Fremtac Fire & Rescue  
Hamilton Hydraulic Services  
Rosenbauer

**ULTRA HIGH PRESSURE SYSTEMS**  
Marcé Fire Fighting Technology  
Rosenbauer  
TFM Industries: Emergency Vehicles

**UNDERWATER BREATHING APPARATUS**  
Divetek Compressors

**UNDERWATER LIFT BAGS**  
Divetek

**UNDERWATER TORCHES**  
Divetek Compressors

**UNIFORMS**  
Marcé Fire Fighting Technology  
Rosenbauer  
Sparks & Ellis

**UNIMOGS**  
Rosenbauer  
TFM Industries: Emergency Vehicles

**URBAN SEARCH AND RESCUE**  
Rescue South Africa

**VALVES**  
DoseTech

**VALVES - REPAIR/SERVICE KITS**  
DoseTech

Marcé Fire Fighting Technology  
Rosenbauer

**VEHICLE MAINTENANCE & REPAIRS**  
Marcé Fire Fighting Technology  
Rosenbauer  
TFM Industries: Emergency Vehicles

**VEHICLE MOUNTED PUMPS**  
Godiva  
Rosenbauer  
TFM Industries: Emergency Vehicles

**VEHICLES, RECONDITIONED/ REFURBISHED**  
Marcé Fire Fighting Technology  
Rosenbauer  
TFM Industries: Emergency Vehicles

**VEHICLE STABILISATION EQUIPMENT**  
Fremtac Fire & Rescue  
Hamilton Hydraulic Services  
Holmatro  
Rosenbauer  
The Rescue Tool Guys

## TRADE MARKS / BRAND NAMES

**ACCURO**  
Dräger South Africa

**ACTION TRAINING SYSTEMS**  
Skills Train Distribution

**AECI**  
Chemsystems

**AEROTEST**  
Dräger South Africa

**AJAX TOOLS**  
Vanguard Fire & Safety

**AKRON BRASS**  
DoseTech

**ALCOLITE FIRELADDERS**  
Fremtac Fire and Rescue

**ALCOTEST**  
Dräger South Africa

**AMERICAN FIREWEAR**  
Vanguard Fire & Safety

**ATLAS**  
Designation Hose

**BG4**  
Dräger South Africa

**BODYGUARD**  
Dräger South Africa

**BLUE DEVIL**  
Fremtac Fire and Rescue

**BULLARD**  
Vanguard Fire & Safety

**C.A.M.P. SAFETY**  
Fremtac Fire & Rescue

**CET PUMPS**  
Marcé Fire Fighting Technology

**CINET**  
Skills Train Distribution

**CMS**  
Dräger South Africa

**COASTAL**  
Skills Train Distribution

**COLTRI**  
Plantfocus

**COMMAND LIGHT**  
Marcé Fire Fighting Technology

**COMPOSITE TECHNICAL SYSTEMS**  
Fremtac Fire & Rescue

**CORE TECHNOLOGY**  
Holmatro

**COSMAS**  
Fremtac Fire & Rescue

**DESERT DIAMOND INDUSTRIES**  
Fremtac Fire & Rescue

**D-MEX**  
Dräger South Africa

**DRAGON FIRE**  
Marcé Fire Fighting Technology

**DR STHAMER**  
Chemsystems

**DUPONT**  
DuPont  
Firebreak

**EAGLE HAZMAT SOLUTIONS**  
Vanguard Fire & Safety

**EAGLE IMAGER**  
Marcé Fire Fighting Technology

**VEHICLE TAIL LIGHTS**  
Marcé Fire Fighting Technology

**VENTILATION SAWS**  
Fremtac Fire & Rescue  
Hamilton Hydraulic Services

**VESTS**  
Firebreak  
Marcé Fire Fighting Technology  
7th Wave Investments  
Vanguard Fire & Safety

**VIDEOS**  
Safety First Association  
Skills Train Distribution

**WARNING LIGHTS**  
DoseTech

**WARNING SYSTEMS**  
Dräger  
Marcé Fire Fighting Technology  
The Sysman Group

**WATER FLOW EQUIPMENT**  
DoseTech

Godiva

**WATER & FOAM TANKS**  
DoseTech  
Hamilton Hydraulic Services  
Rosenbauer  
TFM Industries: Emergency Vehicles

**WATER RESCUE**  
Fremtac Fire & Rescue  
Hamilton Hydraulic Services  
Holmatro  
Marcé Fire Fighting Technology  
The Rescue Tool Guys

**WATER STORAGE TANKS**  
Hamilton Hydraulic Services

**WATER TANKERS**  
Marcé Fire Fighting Technology  
Rosenbauer  
TFM Industries: Emergency Vehicles

**WINCHES**  
Marcé Fire Fighting Technology  
Rosenbauer

**GEAR KEEPER**  
Vanguard Fire & Safety

**GOLLMER & HUMMEL**  
Vanguard Fire & Safety

**GOMDUR**  
Designation Hose

**GOMTEK**  
Designation Hose

**HARVIK**  
Vanguard Fire & Safety

**HEXARMOR**  
Fremtac Fire & Rescue

**HOLMATRO**  
The Rescue Tool Buys

**HONEYWELL**  
Vanguard Fire & Safety

**HURST**  
Hamilton Hydraulic Services

**HUSQVARNA**  
Fremtac Fire and Rescue

**HYDRAM**  
Unqondo Projects

**IDEX**  
DoseTech  
Hamilton Hydraulic Services

**IFSTA**  
Skills Train Distribution

**INTERSPIRO**  
Fremtac Fire & Rescue

**JAMES JONES**  
DoseTech

**JONES AND BARTLETT**  
Skills Train Distribution



**EMALAHLENI LOCAL MUNICIPALITY**

37 Indwe Road Lady Frere  
Eastern Cape 5410  
Private Bag X 1161  
Ladyfrere, 5410  
*Head Office:* Tel no (047) 878 0020  
Fax no (047) 878 0112  
*Dordrecht Office:* Tel no (045) 943 1017  
Fax no (045) 943 1966  
Email: mrwebin@emalahlenilm.gov.za  
Municipal Manager: Dr SW Vatala  
Tel no (047) 878 2004  
Email: vatalas@emalahlenilm.gov.za  
Director Community Services: N Nyezi  
Tel no (047) 878 2008  
Email: nyezin@emalahlenilm.gov.za  
Population: 12 500 Size of area: 10 sq kms  
Budget: R6 000

**ENOCH MGJIMA MUNICIPALITY & FIRE SERVICES (Queenstown)**

8 Owen Str Queenstown  
Private Bag X7111  
Queenstown 5320  
Tel no (045) 807-2601 / 2606  
Fax no (045) 807-2618  
*Fire Brigade*  
Tel no: (045) 839 2233  
1 New Street, Queenstown  
Chief Fire Officer: Ricardo David  
Tel: (045) 807 2678 Cell 079 501 6298  
Email: Fire.Brigade@enochmgijima.gov.za  
Chief Traffic Officer: E Winnaar (27 Owen Street Queenstown)  
Chief Disaster Management: G Judeel  
Size of area: 4444 sq kms  
Population: 200 000  
Emergency calls: Veld fires: 85- Bus/Vehicle fires: 5 - Tankers:2 - Containers:1 - False Alarms:4 - Shack fires:21 - Building / house / school / shop fires:38 - Tip fires:1 - Tyre fires:2 - Others:3  
Fire stations:1  
Personnel:- Officers:1 - Volunteer Fire fighters:15 - Other staff:3  
Budget: R886675.00

**GREAT KEI MUNICIPALITY FIRE DEPARTMENT (Kei Mouth, Cintsas, Haga Haga, Morgansbay)**

17 Main St (Cnr Station Str) Komga  
Private Bag X 2  
Komga 4950  
Head Office: Tel no (043) 831-1028 /831-5700  
Fax no (043) 831-1306  
Cell no 082 778 8500  
Email: info@greatkeilm.gov.za  
Acting Municipal Manager: Vacant  
Email: lmosala@greatkeilm.gov.za

**INXUBA YETHEMBA MUNICIPALITY**

*Cradock Fire Station*  
1 JA Calata St Cradock,  
PO Box 24  
Cradock 5880  
Tel no (048) 801-5000,  
Fax no (048) 881-1421  
Municipal Manager: X Msweli  
Secretary to MM: S Magadu  
Email: mm@ijm.gov.za

Chief Fire Officer: R Hare  
Tel no (048) 801 5061  
Email: Roland@ijm.gov.za  
Community Services Manager: N Thwalo  
Tel no (048) 801 5093  
Email: ntvalo@ijm.gov.za  
Chief Traffic Officer: R Hare  
Disaster Management Officer: R Hare  
Tel no (048) 801 5050  
Email: Roland@ijm.gov.za  
Population: 49 283  
Emergency calls: Rescues/Recoveries:8 - Grass/Veld fires:7 - Building fires:10 - Vehicle fires:3 - Vehicle accidents:35  
Value of property destroyed by fire: R970 000.00  
Mileage of vehicles per annum 1200 kms  
Personnel:- Officers:1 - Volunteer fire fighters:6  
*Middelburg Fire Station*  
Stockenstrom Str Middelburg (Townhall)  
Van Niekerk Str, Middelburg  
PO Box 55 Middelburg 5900  
Tel no (049) 802 1300 / 802 1368  
Fax no (049) 842-1443  
Chief Fire Officer: R Hare  
Tel no (048) 801 5061

**JOE GOABI DISTRICT MUNICIPALITY DISASTER MANAGEMENT AND FIRE RESCUE DEPARTMENT**

*(Maletswai Local Municipality: Aliwal North & Jamestown) (Senqu Local Municipality: Lady Grey, Sterkspruit, Barkly East, Rhodes & Rossouw) (Elundini Local Municipality: Mount Fletcher, Maclear & Ugie) (Gariep Local Municipality: Burgersdorp, Steynsburg & Venterstad))*  
*District Disaster Management & Fire Rescue Main Office*  
Private Bag X102  
Barkly East 9786  
Tel no (045) 939 3000  
Fax no (045) 971 0251  
Director Community Services: F Sephton  
Email: fiona@jgdm.gov.za  
Cell: 082 659 8527  
Manager of the main Centre: Head Disaster Management: P Moko  
Tel no (045) 979 3117  
Cell: 078 958 5949  
Email: patrick@jgdm.gov.za  
*Maletswai Disaster Management*  
Satellite Officer: (Aliwal North & Jamestown) S Sohe  
Tel no (051) 633-2313  
(Fax no (045) 971-0251/ 086 764 7960  
Cell: 073 301 4250  
Email: sakhele@jgdm.gov.za  
*Gariep Disaster Management*  
Satellite Offices: (Burgersdorp, Steynsburg & Venterstad)  
Station Officer: L Marela  
Tel no (051) 653 0770  
Fax no (045) 971 0251  
Cell: 078 268 3441  
Email: lumka@jgdm.gov.za  
*Elundini Disaster Management*  
Satellite offices: (Mount Fletcher, Maclear & Ugie)  
Station Officer: M Mekuto  
Tel no (039) 257 0062  
Fax no (045) 971 2051

Cell: 078 116 7270  
Email: mfundo@jgdm.gov.za  
*Senqu Disaster Management*  
Satellite Offices (Lady Grey, Sterkspruit, Barkly East, Rhodes & Rossouw)  
Station Officer: L Zandile  
Tel no (051) 603 0100  
Fax no (051) 603 0100  
Cell: 081 017 6575  
Email: lwando@jgdm.gov.za  
Operational Head District: J Germishuizen  
Email: dcfo@jgdm.gov.za  
Cell no 084 880 1658  
Chief Fire Officer: K Pitso  
Tel no (045) 979 3146  
Cell: 084 893 4612 / 071 783 5597  
Email: firechief@jgdm.gov.za / pitsoken2@gmail.com  
Size of area: 26518 sq kms  
Population: 308365  
Emergency calls: Rescues/Recoveries:60 - Grass / Veld fires:220 - Building fires:20 - Vehicle accidents:140  
Value of property destroyed by fire: R850 000.00  
Mileage of vehicles per annum: 120 000 kms  
Personnel:- fire fighters 29: Learnership Trainer Fire fighters:10

**KING SABATA DALINDYEBO (KSD) Municipality (Mithatha Local Municipality - Mqanduli Fire & Emergency Services)**

Durham Str Mithatha  
PO Box 45 Mithatha 5099  
Tel no (047) 532 4444 / 047 532 2222  
Fax no (047) 501-4152  
Control Centre Emergency no (047) 501-4444  
Chief Fire Officer: J Subramoney  
Tel no (047) 532 4444  
Cell no 084 225 1970  
Email: jsubramoney@vodamail.co.za / jsubramoney@ksd.org.za  
Divisional Officer: Vacant  
Tel/Fax no (047) 532 4444  
Chief Disaster Manager: MG Kula  
Tel no (047) 501-4188  
Fax no (047) 537-0573  
Chief Traffic Officer: Vacant  
Tel no (047) 501-4188  
Fax no (047) 532-2544  
Municipal Law Enforcement: Head of Department: Vacant  
Tel/Fax no (047) 501-4106  
Chief Protection Services: F Ndinisa  
Tel/Fax no (047) 501-4118  
Director Public Safety: D Kettledas  
Tel/Fax no (047) 501-4315

**KOUGA MUNICIPALITY FIRE DEPARTMENT (Jeffreys Bay, Humansdorp, St Francis Bay, Hankey, Patensie, Loerie - entire EC108 area)**

*Humansdorp Fire Department*  
R330 Hankey Rd, Humansdorp,  
PO Box 21  
Jeffreys Bay 6330  
Emergency no (042) 291-0250  
General number (042) 291-0283  
Chief Fire Officer: D Barnard

Cell no 082 895 5222 / 081 262 4306  
Email: dbarnard@kouga.gov.za  
Disaster Management: J Mazangwa  
Cell no 082 895 3869  
Tel no (042) 291-0250  
Law Enforcement, Traffic and Security: R Prinsloo  
Cell no 073 058 2273  
Office hours Tel no (042) 200 8350  
After hours (042) 291-0250  
Email: rprinsloo@kouga.gov.za  
Traffic: Heugh Street Humansdorp  
Tel no (042) 200 8350  
Ambulance: Tel no (042) 291-0020 / 21

**KOUKAMMA MUNICIPALITY FIRE DEPARTMENT (Joubertina, Kareedouw)**

5 Keet Str Kareedouw,  
Private Bag X011  
Kareedouw 6400  
Tel no (042) 288-7270  
Fax no (042) 288-0797  
Municipal Manager: PM Kate  
Email: katepm@koukamma.gov.za  
Manager Protection Services: W Prins  
Tel no (042) 288 7200/7273  
Fax no 086 571 8276  
Cell no 073 344 0807  
Email: warren.prins@koukamma.gov.za

**MAKANA MUNICIPALITY DEPARTMENT OF FIRE & RESCUE SERVICES**

*(Grahamstown, Alicedale, Riebeeck East, Fort Brown, Salem Carlisle Bridge)*  
PO Box 176 Grahamstown 6140  
Tel no (046) 603-6000  
Fax no (046) 622-7494  
Email: williamwelkom@makana.gov.za  
Municipal Manager: M Mene  
Tel no (046) 603-6132  
Fax no (046) 622-9700  
Director Community and Social Services: K Makgoka  
Tel no (046) 603-6148  
Chief Fire Officer: WJ Welkom  
Tel no (046) 603-6000  
Disaster Management Officer: Vacant  
Tel no (046) 603-6051  
Fax no (046) 622-9474  
Size of area: 4221 sqkms  
Population: ± 120 000  
Emergency calls: - Building fires: 2; - Dwelling fires: 22; - Rescues/Recoveries:2  
Motor vehicle fires:3 - Special Service calls:219 - Fatalities (rescue):0 - Injuries (accidents):134 - Informal dwelling fires:23 - False alarms malicious:0 - Electrical fires:7 - Rubbish / Bush / Grass:58 - Spillages: 0 - Fatalities (accidents):17 - Fatalities(fires):0 - Injuries (fires):0 - Fatalities (electrical):1  
Value of property & contents involved in fires: R1 078 000  
Damage to properties & contents : R 454 500  
Personnel:- Officers:7 - Full-time firefighters:26 - Dispatchers:4 - Other staff:3  
Budget: R10 400 100.00

**MATATIELE PUBLIC SAFETY (Matatiele, Maluti, Cedarville)**

102 Main Str, Matatiele  
PO Box 35

Matatiele 4730  
Tel no (039) 737-8100 / 3135  
Fax no (039) 737-3611  
Email: info@matatiele.gov.za  
Municipal Manager: Dr DCT Nakin  
Tel no (039) 737 8104  
Email: NMBaku@matatiele.gov.za  
Community Services Manager: SM Mbedla (Acting)  
Email: SMbedla@matatiele.gov.za / SNdevu@matatiele.gov.za  
Disaster & Fire Department:  
Tel no (039) 737 9660 Emergency: 039 256 0610  
Cell no 083 785 1944  
Manager Public Safety: ASA Moabi  
Tel no (039) 737 9660  
Cell no 083 785 1944  
Fax no 086 269 1191  
Email: amoabi@matatiele.gov.za  
Station Officer: Fire, Rescue, & Disaster: J Hulley  
Cell no 079 523 2223  
Email: jhulley@matatiele.gov.za  
Size of area: 3 000 sq kms  
Population: 500 000  
Emergency calls: 455  
Value property destroyed by fire: ± R10 000 000.00  
Mileage vehicles per annum: approx 10 000 kms  
Personnel: - Fire fighters:10 - Reserve fire fighters: 260

**NDLAMBE MUNICIPALITY FIRE & EMERGENCY SERVICES**

*(Port Alfred, Bathurst, Kleinemonde, Kenton-On-Sea, Boknes, Bushmansriver and Alexandria)*  
*Main Fire Station:* Cnr Bathurst Street and R72  
Port Alfred Eastern Cape  
PO Box 13  
Port Alfred 6170  
Satellite Fire Station: R72  
Bushmansrivermouth  
Emergency Tel no (046) 624 1111  
Admin Tel no (046) 604 5525/6  
Fax no (046) 624-2077  
Manager: Fire and Emergency Services: M Sauls  
Tel no (046) 604 5536  
Cell no: 079 440 4112  
Email: msauls@ndlambe.gov.za  
Director: Community Protection Services: N Booysen-Willie  
Tel no (046) 604 5528 Ext: 251  
Email: nbooyesen@ndlambe.gov.za  
Municipal Manager: R Dumezweni  
Tel no (046) 604 5566  
Cell no: 072 520 9923  
Email: rdumezweni@ndlambe.gov.za  
Traffic Chief: Fred Cannon  
Tel no (046) 604 5532  
Email: fcannon@ndlambe.gov.za  
Population approximate 63000 residents over an area of approximately 200 000 Square Km  
Personnel: Manager: Fire and Emergency Services/Chief Fire Officer  
Senior Fire Fighters: 4 - Fire Fighters: 7 - Reservist Fire Fighters: 14  
Control Room Operators: 4

**NELSON MANDELA BAY MUNICIPALITY FIRE AND EMERGENCY SERVICES**

City Manager: Mr J Mettler  
Tel: (041) 506-1911  
PO Box 116, Port Elizabeth, 6000  
*Fire and Emergency Services*  
PO Box 579 Port Elizabeth, 6000  
Emergency tel no all stations: (041) 585-1555  
Administration tel no all stations: (041) 585-2311  
Fax no all stations: (041) 585-2318  
Senior Director/Chief Fire Officer: A de Ridder  
Email: aderidde@mandelametro.gov.za  
Secretary to Director: Ms S Schmidt  
Email: SSchmidt@mandelametro.gov.za  
Director Operations: South: Vacant  
Director Operations: North: W A Hendricks  
Email: WHendricks@mandelametro.gov.za  
Size of area: 1950sq kms  
Population: 1 152 115 Value of area Protecting: R136.7 billion  
Emergency calls: Recoveries/rescues:676 - Grass/veld fires:1418 - Building fires:107 - Fatalities:102 - Formal/Informal Dwelling fires:662 - Others:820  
Value of property destroyed by fire: R68 825 000  
Personnel: Officers :56 - Full-time fire fighters:196 - Other staff:55  
Budget: R146 247 880 (Operating)  
Fire stations: 9  
*South End Fire Station*  
Walmer Boulevard, South End, Port Elizabeth  
*Sidwell Fire Station*  
Cadle Street, Sidwell, Port Elizabeth  
*Miramar Fire Station*  
Genadendal Road, Miramar, Port Elizabeth  
*Govan Mbeki Fire Station*  
Old Uitenhage Road, Govan Mbeki, Port Elizabeth  
*Motherwell Fire Station*  
Addo Rd, Motherwell Port Elizabeth  
*Uitenhage Fire Station*  
Cuyler Street, Uitenhage  
*Greenbushes Fire Station*  
Lakeside Road, Greenbushes, Port Elizabeth  
*KwaNobuhle Fire Station*  
Ponatanini Road, KwaNobuhle, Uitenhage  
*KwaZakhele Fire Station*  
Qunta Street, KwaZakhele, Port Elizabeth  
*Markman Training Centre*  
Ranger Street, Markman Industria, Port Elizabeth  
Tel no (041) 508 5660

**OR TAMBO DISTRICT MUNICIPALITY FIRE AND EMERGENCY SERVICES**

*(Mithatha (KSD), Ntabankulu, Ingquza Hill (Flagstaff & Lusikisiki), Mbizana (Bizana), Port St Johns, Nyandeni (Libode & Ngeleni) and Mhlontlo (Qumbu & Tsolo)*  
*OR Tambo District Municipality Offices*  
Magwa House, Nelson Mandela Drive  
Mithatha  
Private Bag X6043  
Mithatha 5099  
Email: info@ortambodm.gov.za  
Municipal Manager: Owen Hlazo (Acting)  
Tel no (047) 501-6400  
Fax no (047) 531-2200  
Email: info@ortambodm.gov.za

Disaster Management Control Centre  
Tel no (047) 501-6494  
Manager Fire & EMS: M Williams (HOD)  
Tel no (047) 501-6475  
Cell no 083 570 7215  
Fax no (086) 6111827  
Email: fire@ortambodm.gov.za /  
meonw@ortambodm.gov.za  
Chief Fire Officer: V Bixi  
Tel no (051) 505 1741  
Email: bixivict@webmail.co.za  
Disaster Management: V Mgobozi  
Email: visi67@webmail.co.za  
Tel no (047) 501-6496  
Fax no (047) 532-2158

**RAYMOND MHLABA LOCAL MUNICIPALITY**

**(Bedford, Adelaide)**  
Market Square, Adelaide  
Private Bag X 350  
Adelaide, 5760  
Tel no (046) 684 0034  
Fax no (046) 684 1931  
Municipal Manager: U Malinzi  
Tel no (046) 645 7400  
Cell no 081 033 0931  
Email: pmadotyeni@raymondmhlaba.gov.za  
Senior Corporate Services Manager: N Fololo  
Tel no (046) 645 7408  
Email: nfololo@raymondmhlaba.gov.za  
Senior Community Services Manager: N Platjies  
Tel no (046) 645 7402  
Email: nplatjies@raymondmhlaba.gov.za  
Chief Traffic Officer: R Duplooy  
Cell 083 861 3949  
Head SAPS: Captain G Briz  
Tel no (046) 684 0030  
Fax no (046) 685-0272  
Size of area: 44 sq kms  
Population: 17 606  
**Bedford substation**  
Donkin Str Bedford  
PO Box 24 Bedford 5780  
Tel no (046) 685-0076  
Fax no (046) 685-0563

**SAKHISIZWE MUNICIPALITY**

**(Elliot, Cala)**  
ERF 5556 Umthatha Rd Cala  
PO Box 26  
Cala 5455  
Tel no (047) 877-5200  
Fax no (047) 877-0000  
Email: kmfundisi@sakhisizwe.gov.za  
Municipal Manager: DM Mvulane  
Disaster Management Official: S Sokhweba  
Tel no (047) 877 5200  
Manager Community Services: M Sikade  
Technical Services Manager: S Tunzi  
**Elliot Office**  
15 Maclear Rd, Elliot  
Tel no (045) 931-1011  
Fax no (045) 931-1361

**SUNDAYS RIVER VALLEY MUNICIPALITY FIRE DEPARTMENT**

**(Kirkwood)**  
30 Middle Str Kirkwood  
PO Box 47  
Kirkwood 6120

Tel no (042) 230-7700  
Fax no (042) 230-1799  
Secretary: Mrs S Sarrahwitz  
Email: Sunes@srvm.gov.za  
Tel no (042) 230-7700/78 Ext: 7737  
Fax no 086 267 6145  
Executive MM Secretary: P Mpakama  
Tel no (042) 230 0077  
Fax no (042) 230 0069  
Municipal Manager: S Fadi  
Tel no (042) 230-77  
Fax no (042) 230-0069  
Email: sydneyf@srvm.gov.za  
Director Corporate Services: T Machelesi  
Tel no (042) 230-7729  
Fax no (042) 230-1799  
Email: tembekilem@srvm.gov.za  
Director Community Services: N Mnyengeza  
Tel no (042) 230-7700  
Fax no (042) 230-1799  
Email: NtombikhayiseM@srvm.gov.za  
Director Infrastructure, Planning & amp;

**DIHLABENG PUBLIC SAFETY (Bethlehem, Bethlehem, Clarens, Fouriesburg, Paul Roux, Rosendal)**

PO Box 551  
Bethlehem 9700  
Tel no (058) 303-5161/2/3/4  
Fax no 086 508 0200  
Email: fireadmin@dihlabeng.co.za /  
charleend@dihlabeng.co.za  
Manager Public Safety: Vacant  
Chief Fire Officer: MP Ntombela  
Email: pntombela@dihlabeng.co.za  
Divisional Fire Officer: Vacant  
Email: fireadmin@dihlabeng.co.za  
Size of area: 620 sq kms  
Population: 352 000  
Value of area protecting: R8 Billion  
Emergency calls:- Rescues:97 - Vehicle accidents:401 - Grass/veld fires:228 - Building fires:63 - Dwelling fires: - Fatalities:14  
Value of property destroyed by fire: R6,0 million  
Personnel: Fire officers:2 - Full-time fire fighters:26  
Budget: R5.6 million

**FEZILE DABI DISTRICT MUNICIPALITY FIRE DEPARTMENT**

**(Frankfort, Villiers, Tweeling, Cornelia)**  
Fezile Dabi District Bulding, John Vorster Rd, Sasolburg  
PO Box 10, Sasolburg, 1947  
Municipal Manager: Ms L Molibeli  
Tel no (016) 970 8607  
Email: lindim@feziledabi.gov.za  
Director Environmental Health & Emergency Services: Vacant  
Tel no (016) 970 8874  
Email: nonhlanhlab@feziledabi.gov.za  
Chief Fire Officer: M Mathibe  
Tel no (016) 970 8843  
Cell no 082 779 0533 Email: mohapim@feziledabi.gov.za  
Shift Leaders: L Lugaga  
Tel no (058) 813 1500

Development:  
M Nzuzo  
Tel no 042-230-7735  
Fax no 042-230-1799  
Email:mpumelelon@srvm.gov.za  
Chief Fire Officer: IP Mazwati  
Cell no 060 533 1901  
Tel no (042) 230 0942  
Fax no (042) 230 1799  
Email: isaacmazwati66@gmail.com  
Chief Traffic Officer: HL Snyman  
Cell: 060 554 8167  
Tel no (042) 230 7700 / 7700  
Fax no (042) 230 1799  
Email:lourenss@srvm.gov.za  
Size of area: 5854,9 sq kms  
Population: 51 581  
Emergency calls:- Grass/veld fires:45 - Building fires:4 - Fatalities:18  
Mileage of vehicles per annum: ± 3000 km  
Personnel: Chief Fire Officer: 1 - Full time Firefighters:7 - Fire Reservist:2

E Mkhwanazi Tel no (058) 813 1500  
T Moloi Tel no (058) 813 1500  
Ms M Lebona Tel no (058) 813 1500  
Administration: N Mthimkhulu  
Tel no (016) 970 8873  
Email: naledim@feziledabi.gov.za

**KOPANONG LOCAL MUNICIPALITY FIRE DEPARTMENT**

**(Bethulie, Edenburg, Fauresmith, Gariep Dam, Jagersfontein, Philippolis, Reddersburg, Trompsburg, Springfontein)**  
20 Louw Str Trompsburg  
Private Bag X 23  
Trompsburg 9913  
Tel no (051) 713-9200 / 9201  
Fax no (051) 713-0292  
Email: lebo@kopanong.gov.za  
Municipal Manager: L Moletsane  
Safety Officer: EP Phaku  
Director Corporate Services: Mrs C Pitso  
Tel no (051) 713-9205  
Email: ceciliam@kopanong.gov.za  
Director Community Services: Vacant  
Size of area: 100 sq kms  
Population: 85 000  
Emergency calls: Grass/Veld fires:10 - Vehicle accidents:12 - Fatalities:1  
Value of property destroyed by fire: R200 000.00

Mileage of vehicles per annum: 300 kms  
Personnel:- Officers:1 - Volunteer fire fighters:5  
Budget: R261 092.00  
**Bethulie Unit**  
Louis Trichardt Sq Voortrekker Str Bethulie  
Tel no (051) 713 9219  
Unit Supervisor: S Zena  
**Edenburg Unit**  
Cnr Loop & Church Sts Edenburg  
Tel no (051) 713 9220  
Unit Supervisor: T Koalepe  
**Fauresmith Unit**  
21 Voortrekker Str Fauresmith  
Tel no (051) 713 9223  
Unit Supervisor: R Phepheng

**Jagersfontein Unit**  
Market Sq Jagersfontein  
Tel no (051) 713 9222  
Unit Supervisor: L Mthata  
**Philippolis Unit**  
50 Kok Str Philippolis 9970  
Tel no (051) 713 9224  
Unit Supervisor: S Ramakoe  
**Reddersburg Unit**  
6 Oranje Str Tel no (051) 713 9221  
Unit Supervisor: PM Modise  
**Springfontein Unit**  
11B Cnr Christia Crause & Van Riebeeck Str Springfontein  
Tel no (051) 713 9225  
Unit Supervisor: N Masantiri  
**Gariep Dam Unit**  
3 Patrys Str, Fonner Park, 9922  
Tel: (051) 713 9227  
Unit Supervisor: M Visser

**LETSEMENG MUNICIPALITY FIRE DEPARTMENT**

**(Koffiefontein, Jacobsdal, Luckhoff, Oppersmansgrond, Petrusburg)**  
7 Groot Trek Str Koffiefontein  
Private Bag X3  
Koffiefontein 9986  
Tel no (053) 330 0200  
Email: info@letsemeng.gov.za  
Municipal Manager: E Mkhwane  
Head Community Services: MC Makhoba  
Communications Officer: A Visagie  
Size of area: 140 sq kms  
Population: 17 000  
Emergency calls:- Grass/Veld fires:10 - Special service calls:4 - Vehicle accidents:28 - Ambulance:800  
Value of property destroyed by fire: R5 000.00  
Mileage of vehicles per annum: 100 kms  
Mileage of ambulances per annum: 12 000 kms  
Personnel:- Officers:1 - Fire fighters:10 - Volunteer firefighters:10 - Reservists:3 - Ambulance attendants:4  
Budget: Fire: R65 700.00  
Ambulance: R280 000.00  
**Jacobsdal Sub-Station**  
Andries Pretorius Str  
PO Box 4  
Jacobsdal 8710  
Tel no (053) 330 0271  
Chief Fire Officer: A Visagie  
**Luckhoff Sub-Station**  
Bosman Ave Luckhoff  
PO Box 7  
Luckhoff 9982  
Tel no (053) 330 0280  
Assistant Chief Fire Officer: Vacant

**MALUTI A PHOFUNG FIRE AND EMERGENCY SERVICES**

**(Kestel, Harrismith, Qwa Qwa Rural, Phuthaditjhaba MAP Farms)**  
Private Bag X 805 Witsieshoek 9870  
Tel no (Fire) (058) 713-1777  
Fax no (058) 713-1124  
Acting Director Public Safety & Transport: MW Matjele  
Tel no (058) 718-3700 / 622 1061  
Fax no (058) 718-3775/7  
Email: matjele@map.fs.gov.za  
Acting Municipal Manager: K Masekoane

Tel no (058) 718 3767  
Fax no (058) 713 6706  
E-mail: mmadmin@map.fs.gov.za  
(Operational) Centralised communication centre: Cnr Bergoord Rd and Cash & Carry  
Fire safety & prevention, fire training, fire operations and disaster management:  
Tel no (058) 713-1777 / 0813 / 1110  
Fax no (058) 713-1124  
Email: malimabes@map.fs.gov.za  
Chief Fire Officer: SS Malimabe  
Divisional Officer: JJ Seleke  
Size of area: 4470 sq kms  
Population: 385 413  
Emergency calls per annum: Motor vehicle accidents:70 - Truck fires:45 - Building fires:291 - Service calls:20 - False calls:15- Veld fires:320 - Mountain rescues:04 - Disasters:03 - Under water rescues:07 - Hazmat incidents:04  
Value of property destroyed by fire: R450 000 000,00  
Personnel:72  
Budget: R18 000 000,00  
Number of Fire Stations: 2  
**Phuthaditjhaba Main Station**  
Tel no (058) 713 1777/ (058) 713 0813/9  
Fax no (058) 713 1124  
**Harrismith Sub-Station**  
Tel no (058) 622-3318  
Fax no (058) 713-1124

**MANGAUNG FIRE & EMERGENCY SERVICE**

**(Incorporating Thaba Nchu & Botshabelo, de Wetsdorp, Wepener & van Stadensrus, Naledi)**  
Head Quarters and Administration:  
5th Floor Gabriel Dichabe Building,  
Charles Street Bloemfontein  
PO Box 196  
Bloemfontein 9300  
**Central Fire Station**  
President Brand Str Bloemfontein  
Tel no (051) 405 8258  
Fax no (051) 406-6487  
E-mail: Sonja.crouch@mangaung.co.za  
Acting Municipal Manager:  
Advocate TB Mea  
General Manager Emergency Services:  
C Lamprecht  
Tel no (051) 406 6305  
Email: chris.lamprecht@mangaung.co.za  
Chief Fire Officer: JM van der Westhuizen  
Tel no (051) 406 6480  
Cell no 082 557 8176  
Email:  
Theuns.vdwesthuizen@mangaung.co.za  
Assistant Chief Fire Officer: MJ Riddle  
Tel no (051) 406 6474  
Fax no (051) 406-6487  
Cell no 082-771-8579  
malcolm.riddle@mangaung.co.za  
Assistant Chief Fire Officer: K P Khutlane  
Tel no (051) 406 6478  
Email: advice.khutlane@mangaung.co.za  
Fax no (051) 406-6487  
Cell no 082-498-7925  
Divisional Officers: JA Van Zyl  
Email: braam.vanzyl@mangaung.co.za  
Acting General Manager Disaster Management: BJH Barnes  
Tel no (051) 406-6353  
Email: billy.barnes@mangaung.co.za

Size of area: ± 9 624 sq kms  
Population: 776 000  
Value of area protecting: R97 807 208 000  
Emergency calls:- Rescues/Recoveries:137 - Grass/Veld fires:427 - Building fires:218 - Fatalities:11 - Vehicle accidents:129 - Dwelling fires:148 - Others:96  
Value of property destroyed by fire: R108 731 220  
Personnel:- Officers:76- full-time fire fighters:168 - Other staff:28

**MANTSOPA MUNICIPALITY DISASTER MANAGEMENT DEPARTMENT**

**(Ladybrand, Excelsior, Tweespruit, Hobhouse, Thaba Patchoa)**  
**Ladybrand Fire Department**  
38 Joubert Str Ladybrand  
PO Box 64  
Ladybrand 9745  
Tel no (051) 924-0654  
Fax no (051) 924-0020  
E-mail: mmsecretary@mantsopa.co.za/  
masejane@mantsopa.co.za  
Municipal Manager: TP Masejane  
Email: masejane@lantic.net  
Director Corporate Services: P Moloi  
Tel no (051) 924 0654  
Fax no (051) 924 0020  
LED Manager: Vacant  
Tel no (051) 924 0654  
Fax no (051) 924 0020  
Chief Human Settlement: E Makateng  
Email: veronicav@mantsopa.co.za  
Traffic Department  
Tel no (051) 924-0654  
Traffic Officers: TP Thamae  
Cell no 083 301 8089  
**Excelsior sub-station**  
PO Box 24  
Excelsior 9760  
Tel no (051) 973-0015,  
Fax no (051) 973-0865  
**Hobhouse sub-station**  
Mellet Str Hobhouse  
PO Box 5  
Hobhouse 9740  
Tel no (051) 983-0013  
Fax no (051) 983-0152  
Technical Officer: Mr Khiba  
Head SAP: Tel no (051) 923 4000  
Tel/Fax no (051) 983-1302  
**Thaba Patchoa sub-station**  
177 Hobhouse Way  
Thaba Patchoa  
Tel no (051) 964-0012  
Fax no (051) 964-0054  
**Tweespruit sub-station**  
5 Peper Street  
PO Box 76  
Tweespruit 9770  
Tel no (051) 963-0061  
Fax no (051) 963-0110  
Cell no 082 953 1364  
Technical Officer: T Mosime  
Cell no 071 856 3120

**MASILONYANA MUNICIPALITY**

**(Theunissen, Brandford, Soutpan, Winburg, Verkeedevlei)**  
Cnr Pienaar & Le Roux Streets  
Theunissen, 9410  
PO Box 8  
Theunissen 9410

**FREE STATE**

Tel no (057) 733-0106,  
 Fax no (057) 733-2417  
 Email: info@masilonyana.co.za  
 Municipal Manager: D Nthau  
 Email: mphol@masilonyana.co.za /  
 corporate@masilonyana.co.za  
 Acting Directorate Social & Community  
 Services: M Maphobole  
 Director Corporate Services: D Mthau  
 Chief Financial Officer: M Mokoena  
 Email: fikilem@masilonyana.co.za  
 Chief Traffic Officer: Vacant  
 Size of area: 80 sq kms  
 Population: 52 000  
 Emergency calls:- Grass/Veld fires:18 -  
 Fatalities:1 - Vehicle accidents:15 -  
 Ambulance:2381  
 Value of property destroyed by fire:  
 R150 000  
 Mileage of vehicles per annum: 218 500 kms  
 Personnel:- Officers:2 - Full time fire fight-  
 ers:8 - Volunteer firefighters:10 - Ambulance  
 attendants:2 - Volunteers:1  
 Budget:  
 Fire:R6 000.00  
 Ambulance: R345 000.00  
*Brandfort sub-station*  
 Brand Str Brandfort  
 PO Box 13  
 Brandfort 9400  
 Tel no (051) 821-2222  
 Fax no (051) 821-1078  
*Soutpan sub-station*  
 Tel no (051) 831-1116/5  
 Fax no (051) 831-1116  
*Verkeerdevlei sub-station*  
 Handel Str Verkeerdevlei  
 PO Box 13  
 Verkeerdevlei 9401  
 Tell/fax no (051) 841-1147  
 Size of area: 6 sq kms  
 Population: 4000  
 Emergency calls: Grass/Veld fires:5  
 Mileage of vehicles per annum: 60 kms  
 Personnel:- Officers:1 - Volunteer fire  
 fighters:7  
 Budget: R902 505.00  
*Winburg sub-station*  
 Brand Str Winburg  
 PO Box 26  
 Winburg 9420  
 Tel no (051) 881-0003  
 Fax no (051) 881-0003  
 Technical Officer: H Brits  
 Size of area: 8 sq kms  
 Population: 36 862  
 Emergency calls:- Rescues:10 -  
 Recoveries:12 Grass/veld fires:15 -  
 Ambulance:1400  
 Mileage of vehicles per annum: 100 kms  
 Personnel:- Volunteer firefighters:3 -  
 Ambulance Attendants:3

**MATJHABENG MUNICIPALITY**  
**EMERGENCY SERVICES**  
*(Welkom, Allanridge, Hennenman,  
 Odendaalsrus, Ventersburg, Virginia)*  
 Volks Rd Doorn  
 PO Box 485  
 Welkom 9460  
 el no (057) 352- 2222 / 1840  
 Fax no (057) 352-4444  
 Emergency no (057) 916 1100  
 PO Box 708 Welkom 9460

Director Social Services and PS&T:  
 Z Dlenzeni  
 Email: info@matjhabeng.co.za  
 Tel no (057) 391 3312  
 Senior Manager Public Safety & Transport:  
 T Mokhuoa Tel no (057) 391 3226  
 Fax: 086-506-0984  
 Email: Teboho.Mokhuoa@matjhabeng.co.za  
 Chief Fire Officer: LF Khuze  
 Cell no 083 506 3578  
 Email: Freddy.Khuze@matjhabeng.co.za  
 Fax2email: 086 5360 549  
 Assistant Chief Fire Officer (Fire Safety &  
 Training): RJF Klaassen  
 Cell no 073 4302 766  
 Email:  
 Francois.Klaassen@matjhabeng.co.za  
 Fax 2 email: 086 511 5276  
 Divisional Officer Operational: MP Khukutli  
 Email: Petrus.Khukutli@matjhabeng.co.za  
 Divisional Officer Operational: TP Moseme  
 Email: Petrus.Moseme@matjhabeng.co.za  
 Disaster Management Organiser: JAG Pottas  
 Email: jan.pottas@matjhabeng.co.za  
 Size of area: 5170 sq kms  
 Population: 405 064  
 Value of area protecting: R994 891 900.00  
 Emergency calls:- Rescues / Recoveries:15 -  
 Grass/Veld fires:324 - Building fires:12 -  
 Vehicle accidents:281- Dwelling fires:212 -  
 Others:108  
 Value property destroyed by fire:  
 R19 5000 000.00  
 Mileage of vehicles per annum: 361 845 kms  
 Fire stations: 4  
 Personnel:- Officers:19- Full-time fire  
 fighters:72 Other staff:3  
 Budget: R 5 954 435.00  
 Personnel:- Officers:19- Full-time fire  
 fighters:72 Other staff:3  
 Budget: R 5 954 435.00  
**Fire Stations / Units**  
*Hennenman Unit*  
 Church Str Hennenman  
 Tel no (057) 573-1820  
*Mmamahabane - Ventersburg unit*  
 N1 Highway  
 Tel no (057) 391 3111/ 391 3110  
*Odendaalsrus unit*  
 Mark Str Odendaalsrus  
 Tel no (057) 354-1111/391-8500  
*Virginia unit*  
 Market Str Virginia  
 Tel no (emergency) (057) 212-5444,  
 (admin) (057) 212-3111  
 Fax no (057) 212-2885  
*Welkom Unit*  
 Volks Rd Welkom  
 Tel no (057) 352-1840

**METSIMAHOLO MUNICIPALITY FIRE**  
**DEPARTMENT**  
*(Sasolburg, Deneysville, Oranjeville)*  
 JG Strydom Road Sasolburg  
 PO Box 60  
 Sasolburg 1947  
 Tel no (016) 973 8864 / 016 976 0945  
 Fax no (016) 976-2474/976-5205  
 Cell no 083 883 6061  
 Municipal Manager: SM Molala  
 Email: steve.molala@metsimaholo.gov.za /  
 molalasm@gmail.com  
 Tel no (016) 973-8314  
 Fax no (016) 976 5205

Chief Fire Officer: JB Mkhwanazi  
 Cell no 073 430 2766  
 Email:  
 james.mkhwanazi@metsimaholo.gov.za  
 Fax no (016) 976 2474  
 Tel no (016) 973-8796  
 Disaster Management: MP Maubane  
 Cell no 073 943 8831  
 Public Safety Management: MA Ramotso  
 Cell no 082 901 5275  
 Email: mokete.ramotso@gmail.com  
 Traffic Chief: MA Mareletse  
 Cell no 083 406 0614  
 Email: aria.mareletse@metsimaholo.gov.za  
 Size of area: 1717423 sq kms  
 Population: ± 213486  
 Emergency calls:- Special service call:321 -  
 Grass/veld fires:610 - Vehicle accidents:689  
 - Dwelling fires: 34 - Fatalities:54  
 Personnel:- Traffic Superintendents:1 - Traffic  
 Assistant Superintendents:2 - Traffic  
 Officers:18 - Station Officers:3 - Fire fight-  
 ers:21  
 Budget: R12.5 million

**MOHOKARE MUNICIPALITY FIRE**  
**DEPARTMENT**  
*(Zastron, Rouxville, Smithfield)*  
*Zastron Office*  
 Hoofd Str Zastron  
 PO Box 20  
 Zastron 9950  
 Tel no (051) 673-9600  
 Municipal Manager: S Selepe  
 Email:  
 zakhele.mphephuka@mohokare.gov.za  
 Chief Fire/Traffic Officer: GF Fredericks  
 Tel: 051 673 1503  
 Size of area: 70 sq kms  
 Population: 8 200  
 Fire stations: 3  
 Personnel:- Officers:1 - Volunteer fire  
 fighters:20  
 Budget: R131 755.00  
*Rouxville Fire Department*  
 280 Church Str Rouxville  
 PO Box 8  
 Rouxville 9958  
 Tel no (051) 663-0008  
 Fax no (051) 663-0400  
 Cell no 073 393 6984  
 Size of area: 8 sq kms  
 Population: 11 000  
 Emergency calls:- Grass/Veld fires:15  
 Mileage of vehicles per annum: 1 000 kms  
 Personnel:- Officers:4 - Volunteer  
 firefighters:3 - Other staff:26 - Ambulance  
 attendants:2  
*Smithfield Fire Department*  
 Cnr Voortrekker & President Strs Smithfield  
 Private Bag X02  
 Smithfield 9966  
 Tel no (051) 683-1143  
 Fax no (051) 683-0341  
 Chief Traffic Officer: Mr. Nyamane  
 Tel: 051 683 0349  
 Size of area: 24 sq kms  
 Population: 8 000  
 Value of property destroyed by fire:  
 R300 000.00

**MOQHAKA MUNICIPALITY EMERGENCY**  
**SERVICES**  
*(Kroonstad, Steynsrus, Viljoenskroon)*  
*Head Quarters Fire Brigade Services*  
 Symonds Str Kroonstad  
 PO Box 302  
 Kroonstad 9500  
 Tel no (056) 216-9111  
 Fax no 086 523 7534 / 056 533 4585  
 Emergency tel no (056) 216-9111  
 Email: puleng@moqhaka.gov.za  
 Municipal Manager: S Mqwathi  
 Tel no (056) 216-9104  
 Fax no (056) 216-9105  
 Director Community & Social Services:  
 PH Tshabalala  
 Tel no (056) 216 9333  
 Fax no (056) 216 9308  
 Chief Fire Officer: JL Ingram  
 Tel no (056) 216 9222  
 Fax no 086 523 7534  
 Email: Lurock@moqhaka.gov.za  
 Cell 078 580 5312  
 Fire Safety & Training Station Officer:  
 WGJ Brand  
 Operational Officers: MS Lekhetsoane and  
 NJJ Labuschagne,  
 DF Nkumbi  
 Size of area: 213 sq kms  
 Population: 260 000  
 Emergency calls:- Rescues:15 - Building  
 fires:49 - Fatalities:29 - Vehicle accidents:133  
 - Flammable Liquids & Gases:2 - Rubbish  
 fires:8 - Grass & Trees:73 - Vehicle fires:8 -  
 Others:23  
 Value of property destroyed by fire:  
 R3 105 000.00  
 Mileage of vehicles per annum: 48 173 kms  
 Personnel:- Officers:5 - Full-time fire  
 fighters:25 - Control Centre:4 - Admin:1  
 Budget: 14 373 567  
*Steynsrus Administrative Unit*  
 Van Riebeeck Str  
 PO Box 6  
 Steynsrus 9515  
 Tel no (056) 471-0006  
 Fax no (056) 471-0428  
 No Fire Station in this administrative unit  
*Viljoenskroon Administrative Unit*  
 Deneysen Str  
 PO Box X02  
 Viljoenskroon 9520  
 Tel: (056) 343-9400  
 Fax (056) 343-2505  
 No Fire Station in this administrative unit

**NALA LOCAL MUNICIPALITY**  
**(Bothaville, Wesselsbron, Kgotsong,  
 Monyakeng)**  
 Preller Str Bothaville  
 Private Bag X15  
 Bothaville 9660  
 Tel no (056) 515 4922  
 Fax no (056) 515-6711  
 Municipal Manager: BC Mokomela  
 Email: mm@nala.org.za  
 Chief Public Safety: NB Ngozo  
 Cell no 083 544 3861  
 Tel no (056) 515 6711  
 Email: Bngoza@nala.org.za  
 Size of area: 3000 sq kms  
 Population: ± 90 000  
 Emergency calls:- Grass/Veld fires: 35 -  
 Building fires: 15 - Vehicle accidents: 30 -

Dwelling fires: 33  
 Value of property destroyed by fire:  
 R2,1 million  
 Mileage of vehicles per annum: 2400kms  
 Personnel:- Officers:5 - Volunteer  
 firefighters:4 - Other staff:4  
 Budget: Fire: R102 979.00  
 Traffic: R448 300.00  
 Disaster Management: R80 000.00  
*Wesselsbron fire station*  
 PL Kotze Str Wesselsbron  
 PO Box 6  
 Wesselsbron 9680  
 Tel no (057) 899-1818  
 Reservist Station Officer: PJA Watkins  
 Tel no 071 600 2669  
*Bothaville fire station*  
 Tel no (056) 515-6711  
 Station Officer: G Erwee

**NGWATHE MUNICIPALITY PROTECTION**  
**SERVICES**  
*(Parys, Vredefort, Koppies, Edenville,  
 Heilbron)*  
 Cnr Phillip & Van der Merwe str, Parys  
 PO Box 359  
 Parys 9585  
 Tel no (056) 811-5834  
 Cell no 082 704 3252  
 Fax no (056) 811-2077  
 Municipal Manager: BW Kannemeyer  
 Tel no (056) 816 2700  
 Email: tsekedip@ngwathe.gov.za  
 Chief Fire Officer: TA Legodi  
 Email: bisho.legodi@gmail.com /  
 movisonica@gmail.com  
 Cell no 082 704 3252  
 Superintendent Traffic Officer: SM Dlomo &  
 AC Roberts  
 Size of area: 800 sq kms  
 Population: ± 150 000  
 Emergency calls:- Rescues:283 - Vehicle  
 accidents:214 - Grass/veld fires:354 -  
 Building fires:15 - Dwelling fires:32  
 Value property destroyed by fire:  
 R3 000 000.00  
 Mileage of vehicles per annum: 40 000 kms  
 Fire stations: 2 (operational); 2 (planned)  
 Personnel:- Officers:3 - Full-time fire  
 fighters:12  
 Budget: R7 000 000.00  
*Edenville Fire Station*  
 Tel no (058) 631 0015 Fax no (056) 631 0019  
*Heilbron Fire Station*  
 Laer Str Heilbron  
 PO Box 45  
 Heilbron 9650  
 Tel no (058) 852-2014  
 Fax no (058) 522-1764  
*Koppies*  
 Tel no (056) 777 1819 Fax no (056) 777 2745  
*Vredefort Fire Station*  
 Kerk Str Vredefort  
 PO Box 16  
 Vredefort 9595  
 Tel no (056) 931-0012 / (056) 811-5834  
 Fax no (056) 931-0082

**NKETOANA MUNICIPALITY FIRE**  
**DEPARTMENT**  
*(Reitz, Petrus Steyn, Arlington, Lindley)*  
 Cnr Church & Voortrekker St, Reitz  
 PO Box 26  
 Reitz 9810

Tel no (058) 863-2811  
 Fax no (058) 863 2523  
 Director Corporate Services: K Nhlapo  
 Email: knhlapo@nketoanafs.co.za  
 Chief Fire Officer/Disaster Officer: T Ncanga  
 Email: thabo@nketoanafs.co.za  
 Chief Traffic Officer: T Mokoena  
 Email: thabiso@nketoanafs.co.za  
 Occupational Health & Safety Clerk:  
 M Radebe  
 Mbiakazi@nketoanafs.co.za  
 Tel no (058) 863-2811 ext 222  
 Population: 35 000  
 Emergency calls:- Rescues:6 - Vehicle  
 accidents:41 - Grass/veld fires:17 - Building  
 fires:0 - Dwelling fires:1  
 Personnel:- Officers:0 - Full-time firefighters:4  
 - Volunteer firefighters:6  
*Arlington Fire Station*  
 Tel / Fax no (058) 453-0034  
 Fax no (058) 453 0733  
 Technical Manager: A Labuschagne  
*Lindley Fire Station*  
 Tel no (058) 463-0004  
 Fax no (058) 463-0182  
*Petrus Steyn Fire Station*  
 Church Str Petrus Steyn  
 PO Box 12  
 Petrus Steyn 9640  
 Tel no (058) 871-3131  
 Fax no (058) 871-3703  
*Reitz Fire Station*  
 PO Box 26  
 Reitz 9810  
 Tel no (058) 863-2811  
 Fax no (058) 863 2523

**PHUMELELA MUNICIPALITY FIRE**  
**DEPARTMENT**  
*(Vrede, Memel, Warden)*  
 52 Kuhn Str (C/O Kuhn & Prinsloo) Vrede  
 Private Bag X5  
 Vrede 9835  
 Tel no (058) 913-8300  
 Fax no (058) 913-2317/3601  
 Municipal Manager: N Malatjie  
 Email: mm@phumelela.gov.za  
 Head of Communications: N Malatjie  
 Manager Community Services: M Motloutung  
 Tel no (058) 913-8300  
 Fax no (058) 913-2317  
*Memel Fire Station*  
 Voortrekker Str Memel  
 PO Box 24  
 Memel 2970  
 Tel no (058) 924-0078/ 0000  
 Fax no (058) 924-0000  
*Warden Fire Station*  
 C/O Pietretief and Agter Ln, Warden, 9870  
 Tel no 058 643 0005 / 0099  
 Fax no 058 643 0310  
 Cell no 076 430 2382

**SETSOTO MUNICIPALITY FIRE SERVICES**  
 27 Voortrekker Str Ficksburg  
 PO Box 116  
 Ficksburg 9730  
 Tel no (051) 933-9300  
 Fax no (051) 933-9309  
 Municipal Manager: TSR Ramakarane  
 Tel no (051) 933-9302  
 Fax no (051) 933-9363  
 E-mail: manager@setsoto.co.za /  
 tshepiso@setsoto.co.za

Director Corporate Services: S Mihailsco (Acting)  
Tel no (051) 933-9303  
Fax no 086 408 0005  
Email: directorcorporate@setsoto.co.za  
Administration Officer: Mrs S Mehaillescu  
Tel no (051) 933-9324  
Email: admin@setsoto.co.za  
Skills Development Facilitator: S Lecheko  
Tel no (051) 933-9447  
Email: sdf@setsoto.co.za

Occupational Health & Safety: Mr. Makhubu  
Tel no (051) 933-9328  
Chief Protection Services: S Lekitlane  
Tel no (051) 933-9336  
Cell no 082 335 2414

Email: buti@setsoto.co.za  
Safety & Security Officer: M Moshodi  
Tel no (051) 933-9381  
Email: moshodi@setsoto.co.za  
Chief Disaster/Traffic Officer: S Lekitlane  
Tel no (051) 933-9326

Email: disaster@setsoto.co.za  
Fire Prevention: JB Renison  
Cell no 073 791 5611  
Population: ± 124 000  
*Ficksburg Station*  
Voortrekker Str Ficksburg  
PO Box 116

Ficksburg 9730  
Tel no (051) 933-9300  
Fax no (051) 933-9309

*Senekal Station*  
48 Van Riebeeck Str Senekal  
PO Box 20  
Senekal 9600  
Tel no (058) 481-2142  
Fax no (058) 481-5154  
Personnel: - Full time member:1 - Paid standby members:14

**TOKOLOGO LOCAL MUNICIPALITY FIRE SERVICES**

*(Boshoff, Hertzogville, Dealesville)*  
Cnr Market Square & Voortrekker Str,  
Boshoff  
Private Bag X46  
Boshoff 8340

Tel no (053) 541-0014  
Fax no (053) 541-0360  
Email: kelehilem@gmail.com  
Municipal Manager: KJ Motlhale  
Chief Traffic Officer: C Grove  
Size of area: 35 sq kms  
Population: 20 000  
Emergency calls: Rescues/Recoveries:1 -  
Grass/Veld fires:10 - Ambulance:700  
Mileage of vehicles per annum: 300  
Personnel: Fire - Officers:1 - Volunteer firefighters:10 - Ambulance attendants:3

**TSWELOPELE LOCAL MUNICIPALITY EMERGENCY SERVICES**

*(Bultfontein, Hoopstad)*  
Civic Centre Bosman Str Bultfontein  
PO Box 3  
Bultfontein 9670  
Tel no (051) 853-1111  
Fax no (051) 853-1332  
E-mail: logov@tswelopele.org  
Municipal Manager: Matiro Mogopodi  
Municipal.manager@tswelopele.org  
Head of Community Services: Vacant  
Email: tindleniz@tswelopele.org

Senior Manager Community Services:  
M January  
Disaster Management: NJ Mambalo  
Occupational Safety Officer: MT Mokoena  
Email: mokoenam@tswelopele.org  
Size of area: 84 sq kms  
Population: Bultfontein:± 1800 -  
Phahameng:± 35000 - Hoopstad:± 1500 -  
Tikwana:± 24000  
Emergency calls: Rescues/Recoveries:2 -

Grass/Veld fires:3  
Value of property destroyed by fire:  
± R 33 000-00  
*Hoopstad Fire Station*  
C/O School and Buiten Street Hoopstad  
PO Box 39  
Hoopstad 9479  
Tel no (053) 444-1897  
Fax no (051) 444 1003  
Cell no 082 574 4942

# GAUTENG

**EKURHULENI METROPOLITAN MUNICIPALITY DEPARTMENT DISASTER AND EMERGENCY SERVICES**

*Emergency Services Division*  
3 Hawley Rd Bedfordview  
PO Box 145  
Germiston 1400  
Emergency Communication Centre: 10177  
Divisional Head: Emergency Services:  
M Makhubalo

Email: Mhlengi.Makhubalo@ekurhuleni.gov.za  
Tel no (011) 999 0187  
Fax No 086 628 2279  
Secretary: S Seanego  
Tel no (011) 999 0191 Fax no 086 627 5811

Email: sarah.seanego@ekurhuleni.gov.za  
Head of Department: Disaster and  
Emergency Management Services:  
S Sibande  
Tel no (011) 999 1735

Executive Manager: Auxiliary Services &  
Training: R Van Vuren  
Tel no (011) 999 1477  
Email: Ryno.vVuuren@ekurhuleni.gov.za

Executive Manager: Fire Safety Services: S  
Du Rand  
Tel no (011) 999 0193  
Email: Sandra.Durand@ekurhuleni.gov.za

Manager of Training Services: T Geldenhuys  
Email:  
Theresa.Geldenhuys@ekurhuleni.gov.za

**OPERATIONS**

*Alberton Fire Station*  
Tel no (011) 999-2527  
*Bedfordview Fire Station*  
Tel no 011 999 2004

*Benoni Central Fire Station*  
Tel no (011) 422-2509  
*Boksburg Central Fire Station*  
Tel no (011) 999 5475

*Brakpan Central Fire Station*  
Tel no 011 999-7728  
Fax no (011) 741-2233

*Daveyton Fire Station*  
Tel no (011) 999-6405  
*Duduza Fire Station*  
Tel no (011) 999 9319

*Edenvale Fire Station*  
Tel no (011) 999-2987  
Fax no (011) 452-9470

*Etwatwa Fire Station*  
Tel no (011) 999 7217  
*Tsakane Fire Station*  
Tel no (011) 999 8039

*Farrarmere Fire Station*  
Tel no (011) 999-8023  
*Germiston Central Fire Station*  
Tel no (011) 999-0629

*Hlahatsi Fire Station*  
Tel no (011) 999 1369  
*Kwa-Thema Fire Station*  
Tel no (011) 999 8742

*Selection Park Fire Station*  
Tel no (011) 999 8557  
*Kempton Park Fire Station*  
Tel no (011) 999 4920

Fax no (011) 970-1428  
*Leon Ferreira Fire Station*  
Tel no ((011) 999-9215  
Fax no (011) 894-7330

*Nigel Fire Station*  
Tel no (011) 999 3892  
Fax no (011)814-8854  
*Ollifantsfontein Fire Station*  
Tel no (011) 999 4684

*Palmridge Fire Station*  
Tel no (011) 999-2986  
*Primrose Fire Station*  
Tel no (011) 999 3795

*Rynfield Fire Station*  
Tel no (011) 999 6892  
*Zonkiszwe Fire Station*  
Tel no: 011-999-1036 / 5190

*Springs Fire Station*  
Tel no (011) 999-6405  
*Tembisa Fire Station*  
Tel no (011) 999 4385

*Thokoza Fire Station*  
Tel no Tel no (011) 999-2795  
*Vosloorus Fire Station*  
Tel no (011) 999 5818/ 999-5067

*Wadeville Fire Station*  
Tel no (011) 999 1290  
Commercia Fire Station  
Tel no 011 999 4527

**PROACTIVE AND LOGISTICS**  
*Codes Eastern Region (Fire Safety)*  
Tel no (011) 999-8099

*Codes Northern Region (Fire Safety)*  
Tel/Fax no (011) 999-3794  
*Codes Southern Region (Fire Safety)*  
Tel/Fax no (011) 999-1532

*Emergency Planning*  
Tel no (011) 999-5491/5967  
*Logistics: Northern Region*  
Tel no (011) 999 6018

Fax no (011) 894 7330  
*Logistics: Southern Region*  
Tel no (011) 999-2534  
*Logistics: Eastern Region*  
Tel no (011) 999-8325

*Training Academy*  
Tel no (011) 999-5811/5790  
*Mess Facilities*  
Tel no (011) 999-6029

*Emergency Communication Centre:*  
10177 / (011) 458 0911

**EMFULENI MUNICIPALITY FIRE AND EMERGENCY SERVICES**  
*(Vanderbijlpark, Vereeniging, Sebokeng, Evaton)*

*Head Office:* PO Box 3  
Vanderbijlpark1900  
Tel no (016) 430 1818/16  
Fax no (016) 455-5389

Chief Fire Officer: PS Mottlashinguping  
Tel no (016)440-1803  
Cell no 082 222 2368  
Fax2email: 086-269 4929 / (016) 455-5389

Email: shadrackm@emfuleni.gov.za  
Deputy Chief Fire Officer: Operations:  
A Nieuwenhuizen  
Tel no (016) 430-1804

Cell no 082 901 5724  
Fax2email: 086-555-5332  
Email antonn@emfuleni.gov.za  
Acting Deputy Fire Chief Officer: Admin &  
Logistics Fire Safety and Disaster

Management: D Marais  
Tel no (016) 430-1805  
Fax2email: 086-269 4211  
Cell no 082 901 5727

Email: dirkm@emfuleni.gov.za  
Regional Commander Disaster Management  
& FPA: C Combrink  
Tel no (016) 430-1812

Fax2email: 086-269 4152  
Cell no 082 610 7432  
Email: chris@emfuleni.gov.za  
Divisional Officer: HP Van Staden

Tel no (016) 430 1814  
Cell: 082 901 5728  
Fax no (016) 455 5389  
Fax2email: 086 269 4333

Email: hennievs@emfuleni.gov.za  
*Region 1 - Vereeniging Fire Station*  
De Villiers Ave Vereeniging

Regional Commander: SL Mokoena  
Tel no (016) 430-1807  
Fax (016) 455-5389  
Cell no 073 364 5731

Fax2email: 086 555 5577  
Email: lucasm@emfuleni.gov.za  
*Region 2 - Vanderbijlpark Fire Station*  
Cnr Frikkie Meyer Blvd & Westinghouse Blvd  
Vanderbijlpark

PO Box 3 Vanderbijlpark 1900  
Regional Commander: MJ Ngubene  
Tel no (016) 430 1856  
Fax no (016) 950-5271

Cell no 072 776 1364  
Fax2email: 086 269 4368  
Email: Jacob@emfuleni.gov.za  
*Region 3 - Evaton Fire Station*  
Cnr Golden Highway & Easton Road, Evaton

Region 4 - Sebokeng Fire Station  
Moshoeshoe Street, Sebokeng  
Regional Commander: EM Mbatha  
Cell. No. 076 055 6874

Email: elliotm@emfuleni.gov.za  
Tel no (016) 430 1837 / (016) 592 9300  
Fax2Email: 086 269 4342  
Population: 721 663 (Census 2011)

Emergency calls:1634 - Fire Calls:770 -  
Other Calls:864  
Personnel:130- Officers:23 - Full-time fire  
fighters:83 - Trainee fire fighters: 20 -  
Administration:1 - Others:3  
Budget: R 65 580 790

**CITY OF JOHANNESBURG MUNICIPALITY EMERGENCY MANAGEMENT SERVICES**  
*(Johannesburg, Midrand, Randburg, Sandton, Roodepoort)*

*Head Office*  
Public Safety Headquarters  
195 Main Road  
Martindale  
2092

Tel no (011) 758-9100  
*Florida Park Fire Station,*  
Ontdekkers Cnr Golf Club Terrace,  
Florida Park  
Tel no (011) 758-5208

Fax no (011) 758-5253  
Emergency call taking centre: (011) 375-6068 /  
(011) 375-5911  
Emergency calls: Fire & Medical: 10177  
Acting Executive Head of EMS: A Mqwa

Tel no (011) 222-8041  
Cell no 082 453 8603  
Email: ArthurMq@joburg.org.za  
Director Strategic Support: N Mtshali

Tel no (011) 222-8044  
Cell no 083 416 1718  
Email: nomathembamt@joburg.org.za  
Director Special Projects: K Gcanga

Email: kayalethugca@joburg.org.za  
Cell no 082 450 0965  
Tel no (011) 222-8065  
Director-Corporate Services: R Monageng

Email: rapulanem@joburg.org.za  
Tel no (011) 222-8060  
Cell no 082 780 0215  
Acting Director Operations: A Mucavele

Tel no (011) 222 8067/68  
Cell no 083 771 9237  
Email: andriesmu@joburg.org.za  
Acting Deputy Director Operations:  
C Setlhako

Tel no (011) 222 8047  
Cell no 083 759 3379  
Email: cedrico@joburg.org.za  
Director-Disaster Management & PIER:  
W Mazibuko

Tel no (011) 222 8015/86  
Cell no 082 460 0386  
Email: williamaz@joburg.org.za  
Director Pro-Active Services/Fire Safety &  
PIER: A Mqwa

Tel no 011 222 8087  
Email: arthurmq@joburg.org.za  
Cell no 082 453 8603  
Fax no 086 636 2080

Deputy Director: Training Academy: Vacant  
Tel no (011) 222 8104  
Fax no (011) 837 0067  
Brixton Training: N Mahlanya

Tel no (011) 222 8104  
Cell no 083 383 8787  
Fax no (011) 837-4172  
Email: nicom@joburg.org.za

Repairs & Maintenance: B Tshiba  
Tel no (011) 624 3014  
Cell no 082 780 0511  
Fax no (011) 614 1463

Fleet: T Mphati  
Tel no (011)758 5233  
Cell no 082 821 3929  
Fax no (011) 381 9233

Fleet-Admin: N Hansel  
Tel no (011) 758 5236  
Fax no (011) 758 5228  
Medical Training: W van der Net

Tel no (011) 758 5209  
Cell no 083 400 3842  
Fax no (011) 758 5211  
Divisional Chief PIER: S Matobako  
Cell 082 490 0519  
Email: synockm@joburg.org.za  
Tel no (011) 222 8023

Divisional Chief Disaster management:  
T Motlhale  
Email: tshepom@joburg.org.za  
Cell no 072 436 6870  
Tel no (011) 222 8015  
Fax no (011) 758 9179

*Operations Divisional Chiefs:*  
*District 1 - (Midrand, Lonehill, Diepsloot,*  
*Ivory Park)*  
Station Commander: C Setlhako

Tel no (011) 847 4616  
Cell no 083 759 3379  
Fax no (011) 847 4623  
*District 2 - (Sandton, Modderfontein,*  
*Alexandra, Northview)*

Station Commander: F Mnguni  
Tel no (011) 286 6000  
Cell no 083 416 6634  
Fax no (011) 883 4651

Email: fanam@joburg.org.za  
*District 3 - (Fairview, Malvern, Central,*  
*Brixton, Berea)*  
Station Commander: Vacant

Tel no (011) 222 8123  
Fax no (011) 614 8891  
*District 4 - (Eldorado Park, Kibler Park,*  
*Turffontein, Orange Farm, Lawley)*

Station Commander: Vacant  
Tel no (011) 434 0202  
Fax no (011) 342-4439  
*District 5 - (Jabulani, Hodgson Fire Station,*  
*Diepkloof, Dobsonville, Rieftontein, Protea)*

Station Commander: Ms Y Mciwa  
Cell no 082 318 5273  
Tel no (011) 222 8198  
Fax no (011) 763 1260

*District 6 - (Randburg, Roosevelt Park,*  
*Rosebank, Huntershill, Florida Park)*  
Station Commander: P Chetty  
Tel no (011) 789 1351

Cell no 083 454 5199  
**Stations & Commanders:**  
*1. Central*  
Station Commander: Vacant

Tel no (011) 331-3141/2  
Fax no (011) 331-3194  
*2. Turffontein*  
Station Commander: A Louw

Cell no 082 318 5244  
Tel no (011) 683-2219  
Fax no (011) 434-3663  
*3. Kibler Park*  
Station Commander: P Dabane

Tel no (011)943-4276/4283  
Cell no 083 416 6682  
Fax no (011) 943-2512  
*4. Eldorado Park*  
Station Commander: V. Venter

Cell no 079 978 9170  
Tel no (011) 342-5361  
Fax no (011) 945-1309  
*5. Fairview*  
Station Commander: Vacant

Tel no (011) 618 4084/5  
Fax no (011) 614-8891  
*6. Malvern*  
Station Commander: Vacant



Tel no (011)614-1945  
 Fax no (011) 614-5791  
 7. Berea  
 Station Commander: Vacant  
 Tel no (011) 642-4669  
 Fax no (011) 642-8618  
 8. Rosebank  
 Station Commander: V Moodley  
 Cell no 079 549 9697  
 Tel no (011) 788-5000/5219  
 Fax no (011) 788-5320  
 9. Brixton  
 Station Commander: J Malan  
 Cell no 082 318 5241  
 Tel no (011) 839 6839  
 Fax no (011) 837-1914  
 10. Roosevelt Park  
 Station Commander: H Ndove  
 Cell no 082 318 5256  
 Tel no (011) 782-4642/3  
 Fax no (011) 788-5320  
 11. Northview  
 Station Commander: F Morukhu  
 Cell no 083 259 8661  
 Tel no (011) 786-3038  
 Fax no (011) 786-2262  
 12. Jabulani  
 Station Commander: E Netshituni  
 Cell no 082-418-0494  
 Tel no (011) 930 4011  
 Fax no (011) 930-3770  
 13. Rietfontein  
 Station Commander: P Oliver  
 Cell no 082 318 5267  
 Tel no (011) 026 9288  
 Fax no (011) 854-7409  
Fire and Hazmat Training Academy  
 Station Commander: Vacant  
Rescue and Training Academy  
 Station Commander: S Knoetze  
 Cell no 083 400 3834  
 14. Sandton  
 Station Commander: A Mlangeni  
 Cell no 082 318 5255  
 Tel no (011) 286-6000  
 Fax no (011) 883-4651  
 15. Lonehill  
 Station Commander: Vacant  
 Tel no (011) 465-5792  
 Fax no (011) 465-5794  
 16. Randburg  
 Station Commander: C Nair  
 Cell no 071 299 7799 / 083 786 8777  
 Tel no (011) 789-1351  
 Fax no (011) 789-1186  
 17. Hunters Hill  
 Station Commander: R. Clark  
 Tel no (011) 794-1684  
 Cell no: 082 318 5247  
 Fax no (011) 794-1701  
 18. Midrand  
 Station Commander: SL Lesetla  
 Cell no 072 687 2638  
 Tel no (011) 847-4604  
 Fax no (011) 847-4623  
 19. Florida Park  
 Station Commander: P Cass  
 Cell no 082 309 1297  
 Tel no (011) 758-5100 /5208  
 Fax no (011) 758-5253  
 20. Hodgson Street  
 Station Commander: W Fritz  
 Cell no 082 774 0287  
 Tel no (011) 763-1111

Fax no (011) 763-1260  
 21. Ivory Park  
 Station Commander: A Makua  
 Cell no 081 436 1508  
 Tel no (011) 204 0693  
 Fax no (011) 261-0305  
 22. Alexandra  
 Station Commander: M Hoosen  
 Cell no 081 365 0666  
 Tel no (011) 985 9744  
 Fax no (011) 011 346-2276  
 23. Diepsloot  
 Station Commander: R Nell  
 Cell no 084 504 1314  
 Tel no (011) 021 9530  
 24. Orange Farm  
 Station Commander: A Kok  
 Cell no 082 318 5265  
 Tel no (011) 850-3916  
 Fax no (011) 850-3196  
 25. Modderfontein  
 Station Commander: W Eberhardt  
 Cell no 082 318 5278  
 Tel no (011) 608-2038  
 Fax no (011) 608-2038  
 26. Diepkloof  
 Station Commander: W Msibi  
 Cell no 072 519 5317 / 081 545 4959  
 Tel no (011) 985-9744  
 Fax no (011) 985-9738  
 27. Dobsonville  
 Station Commander: P Mbalane  
 Cell no 081 520 6913 / 084 413 4740  
 Tel no (011) 989-2931/2  
 Fax no (011) 989-0925  
 28. Lawley  
 Station Commander: C Nyathi  
 Cell no 083 414 1060  
 Tel no (011) 855-1005  
 Fax no (011) 211-9621

**LESEDI MUNICIPALITY FIRE AND RESCUE SERVICES**

**(Heidelberg, Devon, Vischuil, Spaarwater, Driemanskaap, Endicott, Blesbokspruit, Bloekomspuit, Jameson Park, iMpumelelo, Kwazandisele, Kwazenzele)**  
 1 HF Verwoerd Street, Civic Centre Building, Heidelberg, Gauteng 1441  
 PO Box 201  
 Heidelberg 1441  
 Switchboard: (016) 330 0400  
 Emergency no (016) 341 4327 / 3116  
 Chief Fire Officer: MC Masinge  
 Tel no (016) 341 4327  
 Cell no 082 564 6817  
 Email: clementm@lesedi.gov.za / firechief@lesedi.gov.za  
 Size of area: 1550 km<sup>2</sup>  
 Population: 111 000  
 Emergency calls per annum: Fire:200  
 Rescue:90 - Veld fires:240 - Motor vehicle accidents:400 - Hazmat Incidents: 40  
 Fire stations: 2 (Heidelberg & Devon)  
 Personnel: 41

**CITY OF TSHWANE METROPOLITAN MUNICIPALITY**

**Tshwane Emergency Services Department**  
 499 Bosman Str Pretoria  
 PO Box 825  
 Pretoria 0001  
 Tel no (emergency) (012) 310-6300 / 310-6400,  
 Tel no (admin) (012) 310-6200

Fax no (012) 310-6267  
 E-mail:E-mail: preving@tshwane.gov.za / johanpi@tshwane.gov.za  
 City Manager: Dr M Mosola  
 Chief of Emergency Services: PD Govender  
 Strategic Executive Support: Deputy Chief : J Breytenbach  
 Special Operations: Deputy Chief MD Malatji  
 Logistics Support: Deputy Chief R. Brenner  
 Compliance: Vacant  
 Staff Officer: Vacant  
 Spokesperson: District Commander J. Pieterse  
 Management & Administration Support: Director E. Malomane  
 Finance Support: Director: S De Klerk  
 Fire and Rescue Operations: Divisional Chief: MP Mosia  
 Deputy Chiefs Fire and Rescue Operations: S Tshabalala, D Modise, Dr S Khale  
 Business Operations: Divisional Chief : T Terblanche  
 Fire Safety: Deputy Chief SL Combrink  
 Disaster Risk Management: Deputy Chief: M Sebola  
 Emergency Planning: Vacant  
 Emergency Communications: Deputy Chief: R Phantshang  
 Training Academy: Deputy Chief: P Motolla  
 Emergency Medical Operations: Divisional Chief: Dr RL Charles  
 Deputy Chiefs Emergency Medical Operations: A Malatji, R Sebela, P Mashikinya  
 Size of area: 6368 sq. kms  
 Population: 3 350 000  
 Emergency calls per annum): Rescues / Vehicle accidents: 4729 - Grass/veld fires: 2538 - Structural fires: 884 - Shacks: 345 - Special service: 1369 Fatalities: 7 - Pedestrian:1144  
 Value property destroyed by fire: R 263 995 000. 00  
 Emergency Services Budget: R 666 916 619.00  
 Operational Personnel: 913 (Inclusive of all ranks)  
 Station1: Cnr Bosman and Minnaar Sts Central  
 Station 2: 3 Piet Rautenbach St Rosslyn  
 Station 3: 246 Basden Ave Centurion  
 Station 4: Fred Davey Lane Silverton  
 Station 5: Cnr Lavender Rd & Borage Sts Wonderboom  
 Station 6: Lanham Street Extension Bronkhorstspuit  
 Station 7: Cnr Morkel & Trans Oranje Rds Philip Nel Park  
 Station 8: 122 Linvelt Road, Wonderboom Airport  
 Station 9: 979 Park Street Hatfield  
 Station 10: South Street Zone 15 Garankuwa  
 Station 11. Cnr Tsitsa and Lois Sts Erasmusklouf  
 Station 12: 24 Wildeperske Avenue, Heuweloord  
 Station 13: 1st Street Hammanskraal  
 Station 14: C/O Oakley & Montrose Streets, Rayton  
 Station 15: Cnr Ben Swart & Fourteenth Ave Innesdale  
 Station 16: Central Business district Mabopane  
 Station 17: Marivate St Saulsville  
 Station 18: 33 Pinaster St Hazelwood  
 Station 19: Soutpan Road Soshanguve  
 Station 20: Stand 452 Dark City, Ekangala  
 Station 21: Serapeng Avenue, Mamelodi  
 Station 23: Satellite Hammanskraal  
 Station 24: Heinrich Avenue, Pretoria North

**WESTRAND DISTRICT MUNICIPALITY (Mogale City, Westonaria, Randfontein, Merafong City)**  
**Directorate Public Safety**  
 Cnr 6th & Park Rd Randfontein  
 Private Bag X033  
 Randfontein 1760  
 Tel no (011) 411-5000  
 Fax no (011) 412-3663  
 Emergencies: 107 / (011) 951 3000  
 Tel no (011) 411-5205  
 Fax no (011) 411-5260  
 Executive Manager: Public Safety & Regional Support: ME Koloï  
 Tel no (011) 411-5203/5281  
 Cell no 083 2676601  
 Email: ekoloi@wrdrdm.gov.za  
 Acting Manager Disaster Management and Community Safety: C Jordaan  
 Tel no (011 ) 411 5166  
 Cell no 083 2892038  
 Email: pmokoto@wrdrdm.gov.za  
 Manager Emergency Services: N Kahts  
 Tel no (011) 411-5099 Cell no 078 203 5226  
 Email: nkahts@wrdrdm.gov.za  
 Fire Risk Management Co-ordinator: J Botha  
 Tel no (011) 411-5284  
 Cell no 083442 3977  
 Email: jbotha@wrdrdm.gov.za  
 Emergency Calls:1132 -  
 Rescue/Recoveries:1003 - Grass/Veld fires:

399 - Vehicle Accidents:42 - Building fires:42  
**Mogale Emergency Services (Magaliesburg; Muldersdrift; Kagiso, Munsiville; Azaadville, Magalies & district management area included)**  
 Cnr Commissioner & Paardekraal Street Krugersdorp  
 PO Box 1703  
 Krugersdorp 1740  
 Tel no (011) 665-2644  
 Fax no (011) 665-2645  
 Regional Commander: G Nieuwoudt  
 Tel no (011) 411-5099  
 Cell no 083 4608467  
 Email: gnieuwoudt@wrdrdm.gov.za  
 Size of area protecting: 1320 sq kms  
 Personnel: - Permanent:53  
**Fochville Emergency Services (Including Wedela)**  
 129 Kerk Street, Fochville  
 Tel no (018) 771 6023 / (018) 771 5506  
 Fax no (018) 771 6025  
 Regional Commander: Bongani Momoza  
 Tel: 018 771 6023 Cell no 078 979 8493  
 Email: bmomoza@wrdrdm.gov.za  
 Size of area protecting: 783.22 sq kms  
 Personnel: - Permanent:22  
**Carletonville Emergency Services (including Khutsong)**  
 Cnr Onyx & Annan Road

PO Box 6192  
 Oberholzer 2502  
 Regional Commander: Bongani Momoza  
 Tel: 018 786 2223/4 Cell no 078 979 8493  
 Email: bmomoza@wrdrdm.gov.za / st69@wrdrdm.gov.za  
 Tel no (018) 786 2223/4  
 Fax no (018) 786 2227  
 Size of area protecting: 1631.7 sq kms  
 Personnel: Permanent:29  
**Westonaria Emergency Services (Including Bekkersdal)**  
 Cnr Malan & Doveton Strs  
 Tel no (011) 753-3925  
 Fax no (011) 753-4035  
 Cell no 083-460-8466  
 Regional Commander: S Terblanche  
 Cell no 083 460 8466  
 Email: sterblanche@wrdrdm.gov.za  
 Size of area: 617 sq kms  
 Personnel:- Permanent:24  
**Randfontein Emergency Services**  
 Relief Str Randfontein  
 Tel no (011) 693-2234  
 Fax No (011) 693-1031  
 Regional Commander: B Mohlabeng  
 Cell no 083 460 8468  
 Email: bmohlabeng@wrdrdm.gov.za  
 Size of area protecting: 442sq kms  
 Personnel: - Permanent:33

# KWAZULU NATAL

**ABAQULUSI MUNICIPALITY (Vryheid)**  
 Cnr Mark & High Sts, Vryheid  
 PO Box 57  
 Vryheid 3100  
 Tel no (034) 982 2133  
 Fax no (034) 980 9637 / 080 020 0102  
 Email: records@abaqulusi.gov.za  
 Fire Brigade tel no (034) 328 4700  
 Public Safety Manager: Vacant  
 Tel no (034) 982-2276  
 Email: publicsafety@abaqulusi.gov.za / information@abaqulusi.gov.za  
 Municipal Manager: B Ntanz  
 Email: municipalmanager@abaqulusi.gov.za  
 Tel no (034) 982-2133  
 Director Community Services: Ms A Mnikathi  
 Acting Director Corporate Services: N Sibisi  
 Tel no (034) 982-2227  
 Manager: Environment Services: N Kunene  
 Tel no (034) 980-7033  
 Manager Social Services: Ms CM Khumalo  
 Chief Disaster Management: M Naicker  
 Tel no (034) 982-2133  
 Size of area: 4185 sq kms  
 Population: 224 546  
 Value of area protecting: R282 113 770  
 Emergency calls: Vehicle accidents:69 - Grass/veld fires:8 - Building fires:3 - Fatalities:2  
 Mileage of vehicles per annum: 160 kms for fires/ 3009 kms for rescue  
 Value of property destroyed by fire: R18 000.00  
 Personnel: Officers: No permanent firefighters  
 Budget: R717 902.00

**ALFRED DUMA LOCAL MUNICIPALITY:DEPARTMENT COMMUNITY SERVICES, PUBLIC SAFETY**  
 221 Murchison Str Ladysmith  
 PO Box 29 Ladysmith 3370  
 Tel no (036) 631-1777  
 Fax no (036) 631-1029  
 Municipal Manager: Ms SS Ngiba  
 Email: ssngiba@alfredduma.gov.za / kramsaroop@alfredduma.gov.za  
 Executive Director Community Services: PBB Simelane  
 Email: pbsimelane@alfredduma.gov.za / bcombrink@alfredduma.gov.za  
 Manager of Public Safety: M Sewparsad  
 Email: msewparsad@alfredduma.gov.za / ipillay@alfredduma.gov.za  
 Assistant Manager: Traffic: TJ Hlatshwayo  
 Email: tjhlatshwayo@alfredduma.gov.za  
 Assistant Manager: Fire Prevention/Security and Disaster Management: BJ Strydom  
 Email: bjstrydom@alfredduma.gov.za  
 Assistant Manager: Licensing: Ms PI Zwane  
 Email: pizwane@alfredduma.gov.za  
 Assistant Manager: Fleet: M Abdool  
 Email: mabdool@alfredduma.gov.za  
 Manager: Fleet: M Abdool  
 Email: mabdool@ladysmith.co.za  
 Size of area: 4010.13 sq kms  
 Population: 345 823  
 Emergency calls:- Grass/Veld fires:47 - Building fires:52 - Vehicle fires:18 - Others: 33  
 Vehicle fatalities:10 - Dwelling fire fatalities:4  
 Estimate Value property destroyed by fire: R60 million  
 Personnel:- Executive Director:1 - Manager

Public Safety:1 - Assistant Manager Fire:1 - Full-time firefighters:4 - Assistant Manager Traffic:1 -Superintendent Traffic:1 - Assistant Superintendents Traffic:2 - Protection officers Traffic:21 - Land Control Officer:1 - Centralised Communication Centre Control Room Operators:10 - Administrative Personnel:6 - CCTV Camera Room Operators:12 - By-law Officers:5  
 Budget: Traffic: R 22 482 915.00  
 Fire Brigade: R 6 442 751.00  
 Licensing: R 3 230 336.00  
 Disaster Management: R 3 898 995.00 - Fleet Management: R 2 334 304.00 - Security: R 1 663 122.00  
 Total Budget: R40 052 423.00

**EDUMBE MUNICIPALITY PROTECTION SERVICES**

**(Paulpietersburg)**  
 10 Hoog Str Paulpietersburg  
 Private Bag X308  
 Paulpietersburg 3180  
 Tel no (034) 995-1650  
 Fax no (034) 995-1192  
 Cell no 082 628 0716  
 Emergency number tollfree 0800 261 261  
 Email: records@edumbe.gov.za  
 Municipal Manager: MP Khathide  
 Chief Fire/Traffic Officer: TR Nkosi  
 Email: nkositr@edumbe.gov.za  
 Cell no 082 772 0523 / 082 628 0716  
 Size of area: 2800 sq kms  
 Population: 82 207  
 Emergency calls: 200

**EMADLANGENI PROTECTION SERVICES**

34 Voor Str Utrecht  
PO Box 11  
Utrecht 2980  
Tel no (034) 331-3041  
Fax no (034) 331-3040  
Email: lensc@emadlangeni.gov.za  
Municipal Manager: LCT Nkosi  
Chief Protection Services/ Disaster Management: AR Reynard  
Cell no 081 018 9767  
Tel no (034) 331-4180  
Fax no (034) 331-4181  
Emergency calls per annum: 30  
Personnel:- Firefighters: 2

**ETHEKWINI MUNICIPALITY FIRE AND EMERGENCY SERVICES**

15 - 18 ML Sultan Rd Durban  
PO Box 625  
Durban 4000  
Emergency no (031) 361-0000  
Tel no (031) 308-7000  
Fax no (031) 309-1050  
E-mail: Fire@durban.gov.za  
Website: www.durbanfire.gov.za  
Chief Fire Officer: PE Mchunu  
Email: Enock.Mchunu@durban.gov.za  
Tel no (031) 308 7000/ 2/ 7104  
Fax no (031) 309-6088  
Cell no 072 033 8786  
Executive Secretary: C Whitehead  
Tel no (031) 322 8744  
Email: Cheryl.Whitehead@durban.gov.za  
Deputy Chief (Senior Manager Operations): Vacant  
Senior Manager Fire Safety: Vacant  
Assistant Chief (Senior Manager Support Services): S Ravidutt  
Email: Lance.Ravidutt@durban.gov.za  
Tel no (031) 308 7000  
Assistant Chief (Training Manager): AM Gloster  
Email: Alex.Gloster@durban.gov.za  
Tel no (031) 322 0911  
Fax no (031) 309 1050  
Cell no 082 874 8000

**Regions:**

**Central Region**  
Assistant Chief Officer (Regional Commander): Z Ngcece  
Tel no (031) 308-7000  
Fax no (031) 309-1050  
Email: Zibuse.Ngcece@durban.gov.za  
Fire stations: Central, Congella, Jacobs, Chatsworth

**Western Region**  
Assistant Chief Officer (Regional Commander): A Newman  
Tel no (031) 322 2966  
Fax no (031) 702-3178  
Email: Alfred.Newman@durban.gov.za  
Fire stations: Pinetown, Queensburgh, Westville, Pinetown South, Gilllits, Hammarsdale, Cato Ridge

**Southern Region**  
Assistant Chief Officer (Regional Commander): S Mkhulisi  
Tel no (031) 903-9000  
Fax no (031) 903-3172  
Email: Sbu.Mkhulisi@durban.gov.za  
Fire stations: Amanzimtoti, Prospecton, Mobenii, Umlazi, Umkomaas

**Northern Region**

Assistant Chief Officer (Regional Commander): R Sewsunker  
Tel no (031) 584-0400/1/2/3  
Fax no (031) 584-0418  
Email: raj.sewsunker@durban.gov.za  
Fire Stations: Durban North, Phoenix, Umhlanga Rocks, Ntuzuma, Tongaat  
Size of area: 2297 sq kms  
Population: 3811167  
Value of area protecting:  
± R540,822,080,400  
Annual operating budget: R 425,233,270.00  
Emergency calls:- Fire related:9412 (incl 4710 grass/bush fires) - Special services:4659 (incl 51 medical calls) - Fatalities fire related:51 - Special service related:239

**INKOSI LANGA LIBALELE LOCAL MUNICIPALITY**

**(Estcourt, Weenen)**  
Victorious Str, Civic Centre Bulding, Estcourt  
Corner of Elisabeth and Subway Rd (Traffic: Albert Str), Estcourt  
PO Box 15  
Estcourt 3310  
Tel no (036) 342 7800  
Fax no (036) 352 5829  
Emergency no (036) 352-6464 / 352-4444  
Email fire@ilm.gov.za  
Municipal Manager: PS Mkhize (Victoria Str, Estcourt)  
Tel no (036) 342-7800  
Fax no (036) 353 6661  
Email: municipalmanager@ilm.gov.za  
Chief Fire Officer: A Phoswa  
Cell no 082 780 3199  
Email: phoswa@ilm.gov.za  
Fire Safety Officer: S Putterill  
Cell no 083 726 7008  
Email: putterill@ilm.gov.za  
Chief Traffic Officer: Vacant  
Tel no (036) 342 7800  
Fax no (036) 352-5237  
Disaster Management Representative: Vacant  
Size of area: 2130 sq kms  
Population: ± 71 446  
Emergency calls: Grass Fires:214 - Building fires:15 - Dwelling Fires:31 - Vehicle Fires:20 - Vehicle Accidents:40 - Other/Special:267  
Mileage of vehicles per annum: 35 000 kms  
Personnel:- Firefighters:4 (2 Vacant) - Retained firefighters:8 - Fire Station Attendant: 1  
Budget per annum: R1 614 165.00

**KOKSTAD, GREATER FIRE AND RESCUE SERVICES**

75 Hope Str Kokstad  
PO Box 8  
Kokstad 4700  
Tel no (039) 797-6600  
Fax no (039) 727-3676  
Email: Info@kokstad.gov.za  
Municipal Manager: L Mapholoba  
Email: lulamile.mapholoba@kokstad.gov.za  
Chief/Fire Disaster Management Officer: Vacant  
Fire Station Officer: TT Ngodwana  
Cell no 073 196 8066  
Tel no (039) 727 5733  
Senior Supt Traffic & Licencing: M Maphanga

Email: mzomuhle.maphanga@kokstad.gov.za  
Traffic Fine Managing Officer: QG Diedrick  
Tel no (039) 039 797 6713  
Cell no 072 034 8584  
Email: Quintus.Diedrick@kokstad.gov.za  
Size of area: 505 sq kms  
Emergency Calls: Vehicle Accidents:274 - Grass/Veld Fires:412 - Motor Vehicle Clients:196 - Building Fires:1 - Dwelling Fires:22 - Fatalities:16  
Value of property destroyed by fire: ± R5 800 000  
Mileage of vehicles per annum: 120 305 kms  
Personnel:- Firefighters:18 - Fire Fighters:1 - Admin:1 - Station Officer:1 - Firefighters seconded by "Working on Fire" programme:27  
Disaster management and fire rescue budget: GKM Budget R4 304 430.00

**KWADUKUZA MUNICIPALITY FIRE & EMERGENCY SERVICES**

**(Dolphin Coast, Stanger, Zinkwazi, KwaDukuza)**  
14 Chief Albert Luthuli Str, KwaDukuza  
PO Box 72  
KwaDukuza 4450  
Chief Fire Officer: Mrs N Mkhwanazi  
Tel no (032) 437 5515 / 072 426 8208  
Email: NonhlanhlaM@kwadukuza.gov.za  
2 Industria Crescent, Lavoipierre Building, KwaDukuza  
Divisional Officer: AV Naidoo  
Tel no (032) 437 5160 / 072 400 8889  
Email: AnashN@kwadukuza.gov.za  
1 Gledhow Mill Road, KwaDukuza Fire Station  
Station Officer: BR Khumalo  
Tel no (032) 437 5160 / 073 143 1359  
Email: RennieK@kwadukuza.gov.za  
1 Gledhow Mill Road, KwaDukuza Fire Station  
Station Officer: D Govender  
Tel no (032) 946 8039 / 072 404 0398  
Email: DevanG@kwadukuza.gov.za  
**Ballito Drive, Ballito Fire Station**  
Station Officer: SW Gabela  
Tel no. (032) 437 5080/072 557 1392  
Email: WonderG@kwadukuza.gov.za  
1 Gledhow Mill Road, KwaDukuza Fire Station  
Station Officer: A Mohanlal  
Tel no. (032) 437 5570 / 078 380 3129  
Email: AshenM@kwadukuza.gov.za  
PO Box 5  
Ballito, 4420  
**Emergency Call Centre**  
Call Centre Supervisor: N Kleinbooi  
Ballito Drive, Ballito Fire Station  
PO Box 5  
Ballito, 4420  
Tel no: (032) 437 5570  
Emergency line: (032) 946 2711  
Email: EmergencyC@kwadukuza.gov.za  
Administrative Clerk: Miss AS Mbonambi  
1 Gledhow Mill Road, KwaDukuza Fire Station  
Tel no (032) 437-5160  
Email MbonambiA@kwadukuza.gov.za  
Tel no (032) 437-5160  
Size of area: 630 sq kms;  
district 3260 sq kms  
Population: Out season 220 000 / In season

280 000 / District 570 000  
Emergency calls:1100 per annum  
Fire stations: 2  
Personnel:- Fire Dept.: Vacant - Chief Fire and Emergency Services:1 - Divisional Officers:1 - Station Officers:2 - Leading Fire Fighters: 15 Senior Fire Fighter: 3 - Fire fighters:19 - Cadet/Junior Fire Fighters: 18 - Admin Clerk / Secretary:1 - General Assistants: 2 - Emergency Call Centre / Disaster Manager:1 - Call Centre Supervisor: 1- Call Centre Operators:8  
Budget per annum: R21 000 000

**MPOFANA MUNICIPALITY TRAFFIC & SAFETY (Mooi River)**

R103 Main Road, Mooi River Testing Grounds  
PO Box 47,Mooi River 3300  
Tel no (033) 263-7750 / 263 1212 / 263 2862  
Fax no (033) 263-2024 / 086 561 3024  
Email: info@mpofana.gov.za  
Manager Traffic & Safety: PJ Greyling  
Cell no 082 888 7232  
Email: greypaul@telkomsa.net  
Superintendent: D Makhoba  
Cell no 079 871 4373  
Size of area: ± 20 sq km  
Population: 4000  
Emergency calls (Traffic): ±20 per month  
Personnel:- Fire fighters:8

**MSUNDUZI MUNICIPALITY FIRE DEPARTMENT (Pietermaritzburg)**

324 Pietermaritz Str Pietermaritzburg 3201  
PO Box 1490  
Pietermaritzburg 3200  
Tel no (033) 392-3700  
Fax no (033) 392-2509  
Tel no (emergency) (033) 845-5911 / 0800 033911  
Fire & Rescue Services: (033) 845-5900/60  
Emergencies: (033) 845-5911 / 0800 033 911  
Disaster Management: (033) 392-2032 / (033) 845-5960  
Public Safety: Tel no (033) 392-2900  
E-mail: kantharuby.moodley@msunduzi.gov.za  
Manager: Fire Rescue & Disaster Management: WG Paton  
Cell no 082 372 1968  
Acting Municipal Manager: M Hadebe  
Chief Fire Officer: WG Paton  
Cell no 082 372 1968  
Email: billy.paton@msunduzi.gov.za  
Deputy Fire Officer: JG Padayachee  
Cell no 082 780 1176  
Email: juggle.padayachee@msunduzi.gov.za  
Coomunications Officer: Essack Khan  
Tel no (033) 392 3735  
Email: essack.khan@msunduzi.gov.za  
Size of area: 11 311 sq kms  
Population: 800 000  
Emergency calls:- Fire calls - building, transport, veld, grass etc:1603 - Special service calls:489  
Personnel:- Full-time fire fighters:97 - Operational Fire Officers:12 - Support Fire Staff:19 - Support Fire Staff:21 - Support Admin Staff:11

**MTUBATUBA FIRE DEPARTMENT**

Lot 105, INkosi Mtubatuba Rd, Mtubatuba  
PO Box 52  
Mtubatuba 3935  
Tel no (035) 550-0069  
Fax no (035) 550-0060  
Cell no 079 369 4206  
Email: info@mtubatuba.gov.za  
Municipal Manager: JA Mngomezulu  
Email: mm@mtubatuba.gov.za  
General Manager Community Services: MJM Mbatha  
Tel no (035) 550 0069  
Fax no (035) 550 0060  
Fire Protection: Tel no (035) 550 3368  
Manager Traffic / Fire Dept: Mrs NB Dlomo  
Cell no 082 519 4184  
Tel no (035) 550 0168  
Fax no (035) 550 4257  
Email: dlomobongi127@gmail.com  
Chief Public Service (All Enquiries): Mrs NB Dlomo  
Size of area: ± 250 sq kms  
Population: 175 425  
Emergency calls: 60  
Personnel:- Fire fighters: 05

**NEWCASTLE LOCAL MUNICIPALITY DEPARTMENT OF COMMUNITY SERVICES COMMUNITY SAFETY DIRECTORATE**

**Section: Newcastle Fire & Disaster Management**  
3 Albert Wessels Drive, Newcastle  
Private Bag X6621, Newcastle 2940  
Tel no. (034) 328 4700  
Emergency no. (034) 312 1222  
Fax no (034) 328 4746  
Email: Joyce.Gama@newcastle.gov.za  
Municipal Manager: Mr BE Mswane  
Tel no (034) 328-7600 - Fax no (034) 312-7089  
Email: mm@newcastle.gov.za  
Acting Chief Fire Officer: SL Botha  
Tel no (034) 328 4700  
Cell no 079 443 2833  
Email: Stef.Botha@newcastle.gov.za  
**Fire Safety & Disaster Management**  
Divisional Commander: Disaster Management & Fire Prevention: MN Mpeko  
Tel no (034) 328 4700  
Cell no 072 421 8939  
Email: Nelson.Mpeko@newcastle.gov.za  
Strategic Executive Director: Community Services – Mr DB Nkosi  
Tel no (034) 328 7600  
Email: Chiwa.Tshabalala@newcastle.gov.za  
Size of area: 1 894 sq kms  
Population: 363,236  
Emergency calls:- Rescues/Recoveries:155 - Grass/Veld fires:506 - Building fires:18 - Vehicle fires:82 - Dwelling fires:497 - Special service calls:155 - Miscellaneous:43  
Value of property destroyed by fire: R1 851 430.00  
Mileage of vehicles per annum: 547 293 kms  
Personnel:-  
Officers:6 - Full-time Fire Fighters:40 - Control Room Operators:4  
Budget:- Annual Budget: R28 405 609

**OKHAHLAMBA LOCAL MUNICIPALITY FIRE DEPARTMENT**

**(Bergville, Winterton, Cathkin Park)**  
1 Golf St, Bergville  
PO Box 71  
Bergville 3350  
Tel no (036) 448-8000  
Emergency Call Centre no: 0800 111 455 (24 hrs)  
Fax no (036) 448-1986  
Director Social Services: T Mazibuko  
Email: thulani.mazibuko@okhahlamba.org  
Acting Municipal Manager: Y Joyi  
Manager Protection Services: TN Langa  
Tel no (036) 448 1092  
Email: langa3350@yahoo.com  
Superintendent: Disaster Management and Emergency Services: Supt FEA Halgreen  
Cell no 071 168 3260  
Email: feahalgreen@okhahlamba.org  
Size of area: ± 2980 sq kms  
Population: ± 123 106  
Emergency Calls: 120  
Mileage of vehicles per annum: 75000  
Personnel:- Senior Officers:1 - Junior Officers:2 - Fire Fighters:6  
**Winterton Substation**  
Church St Winterton  
PO Box 242 Winterton 3340  
Tel no (036) 488-1620  
Fax no (036) 488-1194

**RAY NKONYENI MUNICIPALITY FIRE DEPARTMENT & DISASTER SERVICES (Hibberdene, Port Shepstone, Margate, Impenjati/Southbroom, Umtumvuna/Port Edward, Margate Airport Management Company)**

Edward, Margate Airport, Ezingoloni )  
Allesund Rd Oslo Beach Port Shepstone  
PO Box 5  
Port Shepstone 4240  
Tel no (039) 688-2000  
Fax no (039) 688-2101  
Municipal Manager: SM Mbili  
Cell no 083 648 7721  
Chief Fire Officer/Chief Disaster Management: S Naidoo  
Cell no 0824182830  
Tel no (039) 688-2095  
Fax no (039) 688-2101  
Email: Selwyn.Naidoo@RNM.gov.za  
Superintendent Traffic Officer: MJ Mzindle  
Cell no 073 180 3190  
Superintendent Traffic Officer: S Ngcaku  
Cell no 078 330 1131  
Size of area: 1200 sq kms  
Population: 460000  
Emergency calls: Rescues/recoveries:61 - Special service calls:93 - Grass/veld fires:981 - Vehicle accidents:728 - Building fires:93 - Dwelling fires:168 - Fatalities:58  
Value property destroyed by fire: ± R8 300 000.00  
Personnel:- Officers:6 - Fulltime fire fighters:61  
Sub Stations: 2  
Airport:CAT 4  
Budget: R34 521 000

**UBUHLEBEZWE MUNICIPALITY FIRE****DEPARTMENT - (IXOPO FIRE****DEPARTMENT**

29 Margaret Str, Ixopo  
PO Box 132  
Ixopo 3276  
Tel no (039) 834-7700  
Fax no (039) 834-1168  
Cell no 082 532 4558  
Email: admin@ubuhlebezwe.gov.za  
Municipal Manager: GM Sineke  
Tel no (039) 834 7700  
Cell no 076 794 7046  
Email: mm@ubuhlebezwe.gov.za /  
zkhumalo@ubuhlebezwe.gov.za  
Chief Disaster Management and Fire Officer  
MW Dlamini  
Tel no (039) 834 2211  
Cell no 0760628953  
Email: wdlamini@ubuhlebezwe.gov.za  
Occupational Health and Safety Officer:  
A Best  
Email: abest@ubuhlebezwe.gov.za  
Tel no (039) 834 7700  
Cell no 0735037177  
Size of area: 1604 sq kms  
Population: 101691  
Emergency calls per annum:138

**UMDONI DISASTER MANAGEMENT FIRE & RESCUE****(Scottburgh Fire Unit: Voluntary)**

Cnr Williamson & Braamfischer Str,  
Scottburgh  
PO Box 19  
Scottburgh 4180  
Tel no (039) 976-1202  
Fax no (039) 976-2194  
Call Centre: (039) 974-1061  
Email: communications@umdoni.gov.za  
Municipal Manager: Acting. T Mhlongo  
Email: mmoffice@umdoni.gov.za  
Chief: Disaster Management Fire & Rescue:  
B Ntebeshe  
Tel no (039) 974-6200  
Cell no 083 879 2095  
Fax no 039 974 1130  
E-mail: bonganin@umdoni.gov.za  
Communications Officer: Z Gcaba  
Cell no 082 930 4753  
E-mail: communications@umdoni.gov.za  
Size of area: 234 sq kms  
Population: 90800  
Fire stations:1  
Emergency calls: approx 1120 P/Annum  
Personnel: Fire Fighters:10 - EPWP Fire  
Fighters Volunteers:13 - Senior Fire fighters:2  
- Control room operators:6

**UMHLATHUZE FIRE AND RESCUE SERVICES****(Richards Bay, Empangeni, eSikhaleni / Vulindlela, Nseleni, Ngwelezane, Felixton, Ntambanana and 4 x Traditional Authority Areas)**

10 Duralumin Duct,  
Alton Richards Bay, 3900  
Private Bag X1004  
Richards Bay 3900  
Tel no (035) 797-4411/2/3 or  
035 797 3314/5 or (035) 9075722/3  
Emergency no (035)797-3911 /  
(035) 797 3313,  
EMRS (Emergency Medical Rescue

**Services)**

Tel no 10177 / (035) 787-6000/1/2/3/4  
Netcare Office tel no: 0800 333 444  
SAPS Control room Tel no: 10111 /  
(035) 9012475  
Traffic Control Room tel no (035) 907 5760/1  
RTI (Road Traffic Inspectorate):  
Tel no (035) 7871464/5  
Municipal Manager: NJ Sibeko  
Tel no (035) 907-5100  
E-mail: SibekoNJ@umhlathuze.gov.za  
Deputy Municipal Manager Community  
Services: T. Mathebula  
Tel No (035) 907-5167  
E-mail: MathebulaT@umhlathuze.gov.za  
Head of Section Public Health and Safety  
Z. Masango  
Tel no (035) 907-5713  
Email:  
Zilindile.Masango@umhlathuze.gov.za  
Manager: Fire Services: AP Vumba  
Tel no (035) 907-5724  
Deputy Manager Fire Services: OM Makgaka  
Tel no (035) 907-5731  
Email:  
Oscar.Makgaka@umhlathuze.gov.za  
Chief Disaster Management Officer: LE  
Dladla  
Tel no (035) 907-5728  
Email: DladlaLE@umhlathuze.gov.za  
Manager: Public Safety and Security: J  
Plaatjies  
Tel no (035) 907-5663  
Email: Johan.Plaatjies@umhlathuze.gov.za  
Chief Traffic Officer: ME Ndlovu  
Tel no (035) 907-5613  
Email: NdlovuME@umhlathuze.gov.za  
Size of area: 795 sq kms  
Population: 334 459  
Total Emergency Incidents:1095  
Emergency Incidents - Fire Related  
Incidents:574 - Rescues and Medical  
Emergencies:454 - Hazardous Materials  
Incidents:1 - Special Services:66 - Fatalities  
at Rescues and Emergencies:57 - Fatalities  
at Fires:3 - Fire Prevention Inspections:1917  
Value of property destroyed by fire:  
R 30 242 500.00  
Value of property threatened by fire:  
R 678 749 200.00  
Mileage of vehicles per annum: 249 556 kms  
Fire stations:5  
Main Fire Stations: Alton, Richards Bay  
Sub-Stations: Empangeni,  
eSikhaleni/Vulindlela, Nseleni and  
Ntambanana  
Airport Fire Houses: 1  
Personnel - Officers: 12 - Full-time  
Fire Fighters:85 - Control Room Operators:4  
Budget: R 71 796 500.00

**UMLALAZI MUNICIPALITY PROTECTION SERVICES****(Eshowe, Mtunzini, Gingindlovu)**

Head Office: Hutchinson Rd Eshowe  
Protection Services: Butcher Str Eshowe  
PO Box 37  
Eshowe 3815  
Tel no (035) 473 3474  
Tel no (035) 474 2909  
Gingindlovu Tel no (035) 473 3470  
Mtunzini Tel no (035) 473 3460  
Municipal Manager: RP Mnguni  
Email: mm@umlalazi.org.za

Tel no (035) 473-3337  
Director Corporate Services: Mr Zulu  
Tel no (035) 473-3315  
Director Community Services: BC Sithole  
Tel no (035) 473-3407  
Senior Manager Protection Services: X Blose  
Tel no (035) 473 3425  
Email: xolani@umlalazi.org.za  
Fire stations: 3 Personnel:- Fire fighters:11

**UMNGENI LOCAL MUNICIPALITY (Howick)**

Cnr Somme & Dicks Str Howick  
PO Box 5  
Howick 3290  
Tel no (033) 239 9284  
Fax no (033) 330-4183  
Control room tel no (033) 239-9244  
Municipal Manager: S Buthelezi (Acting)  
Email: sandile.buthelezi@umngeni.gov.za  
Tel no (033) 239-9266  
Fax no (033) 330-4183  
Chief Traffic Officer: B Smith (Acting)  
Tel no (033) 239 9231  
Cell no 082 303 8392  
Email: Blake.Smith@umngeni.gov.za  
Manager Disaster Services: JT Nzimande  
Tel no (033) 339 9252  
Cell no 083 537 2048 / 079 874 4974  
E-mail: Jerome.Nzimande@umngeni.gov.za  
Size of area: ±300 sq kms  
Population: 100 000  
Emergency calls: 1400  
Personnel:- Firefighters:18 - Divisional  
Officer:1

**UMUZIWABANTU MUNICIPALITY (Ngabeni to Ingeli)**

Murchison Str  
Private Bag X 1023,  
Harding 4680  
Tel no (039) 433-3500  
Fax no (039) 433-1208  
Emergency Fire: 083 301 2528 /  
083 499 2220 / 073 322 8043  
Chief Fire/Traffic Officer: KR Ndlovu  
Tel no (039) 433 1849  
Cell no 083 668 5341  
Municipal Manager: SD Mbhele  
Email: sazi@umuziwabantu.gov.za

**UMVOTI MUNICIPALITY (Greytown)**

41 Bell Str Greytown  
PO Box 71  
Greytown 3250  
Tel no (033) 413-9100  
Fax no (033) 417-1393  
Fire Brigade tel no (033) 417 2911  
Email: info@umvoti.gov.za  
Municipal Manager: TN Ngiba  
Email: mmpa@umvoti.gov.za /  
kmaharaj@umvoti.gov.za  
Head Admin: Ms. Kajal Maharaj  
Tel no (033) 413-9101  
Fax no (033) 417-1393  
Email: Sanele.Shezi@umvoti.gov.za /  
Dudu.mazeka@umvoti.gov.za  
Fire Chief Officer: F Aboobaker  
Tel no (033) 413 9134  
Cell no 079 491 9938  
Disaster Manager: BO Vilakazi  
Tel no (033) 413 1322  
Fax no 033 413 9134

Cell no 082 810 6006  
Email: bhukumuzi.vilakazi@umvoti.gov.za  
Manager of Communications: IJ Archer  
Tel no (033) 413-9161

**UMZINYATHI DISTRICT RURAL METRO EMERGENCY MANAGEMENT SERVICES (Glencoe, Dundee)**

8 Diaz Str  
Dundee 3000  
Tel no (034) 212-2222  
Fax no 086 521 8009  
All hours control room (034) 212-2222  
Municipal Manager: S Ndabandaba  
Tel no (034) 219 1500  
Email:  
siphon.ndabandaba@umzinyathi.gov.za /

**BA-PHALABORWA MUNICIPALITY PROTECTION SERVICES FIRE & RESCUE OPERATIONS****(Phalaborwa to Strydom tunnel)**

Mopani District Municipality Fire & Rescue  
Services  
Cnr Palm and Sealene St Phalaborwa  
Private Bag x 9687  
Giyane 0826  
Tel no (015) 781-7081/781-7008  
Emergency no (015) 781-1333  
Fax no (015) 781-7082  
Cell no 061 887 1208  
Municipal Manager: Ml Moakamela  
Tel no (015) 811 6300  
Email: KgatlaQ@mopani.gov.za  
Director Community Services: DD Shitlangu  
Chief Fire Officer: JD Visser  
Cell no 082 802 3837  
Divisional Officer: Fire: NM Letsoalo  
Station Commander Ambulances: SS Sambo  
Tel no (015) 769-4011  
Disaster Manager: KJ Mphahlele  
Tel no (015) 780-6300  
Chief Traffic: HZ Bezuidenhout  
Tel no (015) 780-6300  
Size area: ± 299 975sq kms  
Population: ± 129134  
Emergency calls:- Rescues/Recoveries:164 -  
Grass/Veld fires:46 - Building fires:35 -  
Fatalities:288 - Vehicle fires:20 - Hazmat calls:3  
- Special services:84 - Electrical fires:5  
Value of property destroyed by fire:  
R1.8 million  
Mileage of vehicles per annum: 56 288 kms  
Personnel:- Officers:2 - Full-time Fire fighters:8  
- Clerk:1 - Volunteers:5

**BELA-BELA MUNICIPALITY FIRE DEPARTMENT****(Warmbaths)**

59 Chris Hani Drive Warmbaths  
Private Bag X1609  
Bela Bela 0480  
Tel no (014) 736-8000  
Fax no (014) 736-3288  
Manager: MS Makhubela  
Email: makhubelams@belabela.gov.za  
Divisional Manager: Protection and  
Emergency: I Monare  
Cell no 079 875 6777

mm@umzinyathi.gov.za  
Station Officer: Z Mhlungu  
Email: zamani.mhlungu@umzinyathi.gov.za /  
zamanimhlungu001@gmail.com  
Population: 35 000  
Personnel:- Officers:1 - Firefighters:8

**UPHONGOLO LOCAL MUNICIPALITY**

61 Martin St, Pongola  
PO Box 191 Pongola 3170  
Tel no (034) 413-1223  
Fax (034) 413-1706  
Email: info@uphongolo.gov.za  
Traffic Department: Tel no (034) 413 2497  
Municipal Manager: WM Nxumalo  
Tel no (034) 413-1223  
Fax no (034) 413-1706

**LIMPOPO**

Population: 40 000 Emergency calls: 50  
Personnel: Part-time Firefighters: 10

**ELIAS MOTSOLEDI LOCAL MUNICIPALITY FIRE DEPARTMENT**

2 Grobler Ave Groblersdal  
PO Box 48  
Groblerdal 0470  
Tel no (013) 262-3056  
Fax no (013) 262-4883  
Fire no (013) 262 7300  
Emergency: 013 262 3024  
Email: amotha@emlm.gov.za  
Municipal Manager: Mrs RM Maredi  
Email: rmaredi@emlm.gov.za  
Director: Community Services:  
GE Kegopotsemang  
Manager: Traffic & Licensing: C Coetzee  
Email: ccoetzee@emlm.gov.za  
Cell no 082 494 0890  
Population: approx 320 000  
Emergency calls: ±10  
Personnel:- Fire fighters:6

**EPHRAIM MOGALE LOCAL MUNICIPALITY**

Traffic / Fire / Rescue and Disaster  
13 Ficus Str Marble Hall  
PO Box 111  
Marble Hall 0450  
Website: www.ephraimmogalelm.gov.za  
Tel no (013) 261-8400  
Fax no (013) 261-2985  
Municipal Manager: Ms MM Mathebela  
Email: rkekana@emogalelm.gov.za  
Manager Community Services:  
C Badenhorst  
Email: omogamedi@emogalelm.gov.za  
Cell no 082-695-5326  
Leeuwfontein Office: Tel no (013) 266-7025  
Elandskraal Office: Tel no (013) 368-0204  
Traffic Divisional Manager: C Baker  
Cell no 082 465 7018  
Email: cbaker@emogalelm.gov.za  
Medical Fire Rescue Officers:  
CJJ Beirowski Cell no 082 576 0528  
K O'Connell Cell no 082 575 8134  
Size of area: 80 59 sq kms  
Population: ± 172 000  
Emergency calls:- Building fires:3 - Vehicle  
accidents:86 - Vehicle fires:0 - Medical  
emergencies:6 - Trauma:14

E-mail: mm@uphongolo.gov.za  
Manager Community Services: SP Simelane  
Tel no (034) 413-1223  
Chief Protection Officer: SD Sithole  
Cell no 082 832 9454  
Superintendent Traffic: Vacant  
Tel no (034) 4132497  
Cell no 072 232 0679  
Safety Officer: N Phakathi  
Ambulance Service; 10177 / (034) 413 1323  
Size of area: 157 sq kms  
Population: Trust:147000 - Sugar Mill:2000 -  
Farmers:2000 - Pongola Town:6800  
Personnel:- Permanent staff:8 - Admin:4 -  
Reserves:3

Value of property destroyed by fire:  
±R100 500.00  
Mileage of vehicles per annum:  
± 10 000 kms  
Personnel:- Volunteer fire fighters: 5

**MOGALAKWENA MUNICIPALITY FIRE DEPARTMENT/MOKOPANE (Potgietersrus)**

32 Nelson Mandela Dr Mokopane  
PO Box 34  
Mokopane 0600  
Switchboard no (015) 491 9600  
Tel no (015) 491-9800  
Fax no (015) 491-9755  
Cell no 082 300 1414  
Municipal Manager: MM Mthombeni  
Tel no (015) 491-9604  
Manager: Traffic & Emergency Services: MM  
Mthombeni  
Tel no (015) 491 9813  
Size of area: ± 30 kms radius  
Population: ± 600 000  
Emergency calls: 420  
Personnel:- Officers:4 - Fire fighters:6 -  
Control Room attendance:4 - Control Room  
Supervisor:1 - Total personnel for Fire  
Service:14

**MOOKGOPHONG FIRE DEPARTMENT (Naboomspruit, Roedtan)**

Mandela Drive, Mookgophong  
Private Bag X340  
Mookgophong 0560  
Tel no (014) 743-6600  
Fax no (014) 743-2434  
Email: admin@mookgophong.gov.za  
Municipal Manager: OP Sebola (Acting)  
Head Communications: Lerato Makomene  
Tel no (014) 743 6600  
Email: ajdotraf@gmail.com  
Community Services Manager: NS  
Monyamane  
Social Development Manager: MR Boloka  
Cell no 074-516-3137  
Size of area: ± 568 km radius  
Population: 32000  
Fire calls: 89 - Ambulance: 2300  
Personnel:- Firefighters:16

**MOPANI DISTRICT MUNICIPALITY**  
**(Giyani, Letaba, Tzaneen, Ba-Phalaborwa, Maruleni)**

Old Parliament Building  
Government Building, Main Road, Giyani  
Private Bag x 9687, Giyani, 0826  
Tel no (015) 811 6300  
Fax no (015) 812 4302  
Email: tim@mopani.gov.za  
Municipal Manager: Q Kgatla  
Chief Fire Officer: JD Visser  
Cell no: 082 802 3837  
Email: kobusvisser@yahoo.com  
Assistant Chief Fire Officer: V v/d Westhuizen  
Station Commanders:  
*Tzaneen Fire Station*  
Acting Station Commander: L Stemmett  
Tel no (015) 307 8000  
*Modjadjiskloof Fire Station:*  
M Rakomana  
*Giyani Fire Station:*  
P Tshidavuhula (Acting)  
*Ba-Phalabora: MN Letsoalo*  
*Maruleng Fire Station:*  
MJ Mohale (Acting)  
Disaster Management Centre Manager:  
JJ Steyn  
Personnel: Officers:7 - Fire Fighters:48 -  
Admin:4

**MUSINA EMERGENCY SERVICES**  
**(Vhembe)**

National Road Musina  
Private Bag x 611  
Musina 0900  
Switchboard tel no (015) 534-6100  
Tel no (015) 534-0061  
Emergency no (015) 534-0270 / 0061  
Fax no (015) 534-3133  
Email: info@musina.gov.za  
Chief Fire Officer: M Budeli  
Email: BudeliM@vhembe.gov.za  
Tel: 015 961 6944 / 6913  
EMS Coordinator: Mrs JM Jordan  
Fire Divisional Officer: K Van Der Walt  
Tel no (015) 534 0270 / 3642  
Cell no 082 481 3930  
Email: vanderwalk@vhembe.gov.za  
Municipal Manager: C Phiri  
Tel no (015) 534-6181  
Fax l no (015) 534-2513  
Email: info@musina.gov.za  
Head of Communications: W Dzebu  
Tel no (015) 534-6132  
Fax no (015) 534-2513  
Cell no 083 457-2187  
Email: info@musina.gov.za  
Acting General Manager: NP Demana  
Chief Traffic Officer: J Roos  
Lt Colonel: VR Mashego  
Tel no (013) 764 1211 ext 33 / 082 828 1210  
Size of area: ± 12 000 sq kms  
Population: 60 000  
Emergency calls:- Rescues/Recoveries:52 -  
Grass/Veld fires:48 - Building fires:25 -  
Vehicle accidents:82 - Dwelling fires:10 -  
Hazmat spills:21  
Value of property destroyed by fire:  
R900 000.00  
Mileage of vehicles: 180 000 kms  
Personnel:4

**POLOKWANE MUNICIPALITY FIRE & EMERGENCY SERVICES**

**(Pietersburg, Mankweng, Seshego, Moletji, MajaChuene, Seabajeng)**  
Vermiculite Str Laboria Pietersburg  
PO Box 111  
Polokwane 0700  
Tel no (015) 290-2000  
Fax no (015) 290-2450  
Emergency no (015) 293-1111  
Fire Department (015) 290 2403/5  
Municipal Manager: D Makobe  
Tel: 015 290 2102  
Email: MakobeD@polokwane.gov.za  
Manager: Disaster and Fire Services: P Kabe  
Tel no (015) 290 2405  
Email: KabeP@polokwane.gov.za  
Manager: Environmental Health: Johan Swanepoel  
Tel no (015) 290 2350  
Email: SwanepoelJ@polokwane.gov.za  
Size area: 10,000 sq kms  
Population: ± 60 000  
Emergency calls: 212  
Fire stations: 2  
Personnel:- Firefighters:33

**THABAZIMBI MUNICIPALITY PROTECTION SERVICES**

**(Northam, Rooiberg, Leeupoort, Dwaalboom)**  
7 Rietbok Str Thabazimbi  
Private Bag X530  
Thabazimbi 0380  
Tel no (014) 777-1525  
Fax no (014) 777-1531  
Email: info@thabazimbi.gov.za  
Emergency standby cell no 083 687 1883  
Limpopo Province Emergency Medical Services Tel no 10117  
Mr. GC Booysen  
Email: info@thabazimbi.gov.za  
Head of Communications: J Motsamane  
Email: motsomanej@thabazimbi.gov.za

**TZANEEN, GREATER MUNICIPALITY**

PO Box 24  
Tzaneen 0850  
Tel no (015) 307-8000  
Fax no (015) 307-8049  
Fire Department Tel no (015) 306-7051  
EMS tel no (015) 307 7077  
Disaster no (015) 306 7010  
Email: mandy.arjoon@tzaneen.gov.za  
/Winnie.baloyi@tzaneen.gov.za  
Municipal Manager: B Mathebula  
Tel no (015) 307-8246  
Cell no 079 692 3719  
Station Officer Prevention: L Stemmett  
Chief Fire Officer: JD Visser  
Tel no (015) 306 7051  
Cell no: 082 802 3837  
Email: kobusvisser@yahoo.com  
Acting Disaster Management:  
MM Rabothata  
Disaster Management Centre Manager:  
JJ Steyn  
*Mopani Sub-station*  
Emergency tel no (015) 307 5555 / 6666  
Disaster Centre tel no (015) 306 7000  
Size of area: 3240 sq kms

Population: 484 053 000  
Emergency calls: 1015  
Value property destroyed by fire:  
± R18 000 000  
Personnel:- Officers:1 - Fire fighters:13  
Acting Chief fire Officer: 1

**VHEMBE DISTRICT MUNICIPALITY FIRE BRIGADE**

**(Louis Trichardt)**  
Private Bag X5006  
Thohoyandou 0950  
Tel no (015) 961 6944 / 6913  
Municipal Manager: M Rambado  
Tel no (015) 960 2009  
Chief Fire Officer: M Budeli  
Email: BudeliM@vhembe.gov.za  
Tel no (015) 961 6944 / 6913  
Safety Officer: S Sibara  
Email: SibaraS@vhembe.gov.za  
Training Officer: S Mphuma  
Email: MphumaS@vhembe.gov.za  
General Manager Emergency Services:  
M Nnditsheni  
Email: Mathulen@vhembe.gov.za  
*Makhado Fire Station* (Louis Trichardt)  
Divisional Officer: MJ Ramalatsso  
Tel no (015) 516 55 88 / 083 694 7031  
*Vuwani Fire Station*  
Tel no (015) 961 6944 /6916  
*Obed Mashaba Fire Station* (Musina)  
Tel no (015) 534 0270  
*Ramushwana Fire Station* (Thohoyandou)  
Tel no (015) 962 4155/0972  
*Mutale Fire Station*  
Tel no (015) 967 0123/0121  
Population: ±532 085  
Size of area: 16 000 sq kms  
Emergency calls: Fire calls:233 - Grass/veld fires:168 - Building/vehicle & other fires:65  
Motor vehicle accidents:112  
(patients/deceased victims extricated:46)  
Special services:98  
Value of property destroyed by fire:  
R4 638 500 (excluding grass/veld fires)  
Value of risk involved during fires (property protected): R75 572 000  
Mileage of vehicles per annum: 31 539 kms  
Personnel:- Officers:1 - Fire fighter:13 -  
Part-time fire fighters:2 - Others:1

**WATERBERG DISTRICT MUNICIPALITY**

Harry Gwala Street, Modimolle  
Private Bag X1018  
Modimolle, 0510  
Te no (014) 718 3300  
Fax no (014) 717 2931  
Municipal Manager: M Samuel Mabotja  
Tel no (014) 718 3321 / 3320  
Fax no (014) 717 2931  
Head of Communications: P Maletle  
Tel no (014) 718 3324  
Fax no (014) 717 3689  
Cell no 082 441 1218  
E-mail: pmaletle@waterberg.gov.za  
Fire Chief: D Mokonyama  
Cell no 082 664 1159  
Fax no (014) 717 2931  
Email: dmokonyama@waterberg.gov.za

# MPUMALANGA

**CHIEF ALBERT LUTHULI MUNICIPALITY FIRE, RESCUE AND DISASTER MANAGEMENT**

**(Carolina, Emanzana, Empuluzi, Elukwatini, Ekulindeni)**  
28 Kerk Str Carolina  
PO Box 24  
Carolina 1185  
Head Office Tel no (017) 843-4000 ext 236  
Fax no 086 639 4001  
Municipal Manager: MS Dlamini  
Tel no (017) 843-4026  
Email: : mandla@albertluthuli.gov.za  
Head of Communications: SD Nhlabathi  
Tel no (017) 843 4037  
Email: nhlabathisd@albertluthuli.gov.za  
Department: Community and Public Safety  
Directorate: WS Shabangu  
Tel no (017) 843 4071  
Email: shabangujw@albertluthuli.gov.za  
*Fire Station*  
1016 Pearce Street  
Fire, Rescue & Disaster Management  
Sectional Head: FS Gumede  
Tel no (017) 843 4033  
Cell no 082 4392 785  
Fax no 086 6178 817  
Email: gumedefs@albertluthuli.gov.za  
Emergency no (017) 843 4011  
Stand by no 078 80 1975  
Personnel: Fire Fighters:13 - Leading Fire  
Fighter:1 - Disaster Coordinator:1  
Population: ± 208812  
Emergency calls: 30566

**DR PIXLEY KA ISAKA SEME LOCAL MUNICIPALITY FIRE BRIGADE SERVICES**  
**(Volksrust, Amersfoort, Wakkerstroom, Perdekop, Daggakraal)**

Cnr Adelaide Tambo & Dr Nelson Mandela Drive Volksrust  
Private Bag X9011  
Volksrust 2470  
Tel no (017) 734-6100/6101  
Fax no (017) 735-3004/086-630-2209  
Email: records@pixleykaseme.gov.za  
Municipal Manager: PB Malebye  
Tel no (017) 734 6101  
Email: faith@pixleykaseme.gov.za  
Head of Communications: S Ndlela  
Tel no (017) 734-6159  
Cell: 072-186-2483  
Email: sibonelon@pixleykaseme.gov.za  
Manager Public Safety: S Ngwenya  
Tel no (017) 7346334  
Email: sam@pixleykaseme.gov.za  
Tel no (017) 734 6334  
Fax no 086 630 2209  
Cell no 082 780 3232  
Size of area: 50 sq kms  
Population: 80 737  
Emergency calls:- Rescues/Recoveries:17 -  
Grass/Veld fires:135 - Building fires:28 -  
Vehicle accidents:146 - Dwelling fires:52 -  
Value of property destroyed by fire:  
R547 000.00  
Mileage of vehicles per annum: 429 000 kms  
*Volksrust Fire Station*  
C/O Laingsnek and Joubert Street

Volksrust 2470  
*Offices:*  
*Perdekop Office*  
Tel no (017) 785 1197  
*Wakkerstroom Office*  
Tel no (017) 730 0069  
*Amersfoort Office*  
Tel no (017) 753 1006  
Personnel:- Officers:1 Vacant post of Chief  
Fire Officer:1 - Fire Fighters:7  
Budget: R386 700.00

**EMAKHAZENI MUNICIPALITY FIRE DEPARTMENT**

**(Belfast, Dullstroom, Machadodorp, Waterval-Boven, Wonderfontein)**  
25 Scheeper Str Belfast  
PO Box 17  
Belfast 1100  
Tel no (013) 253-7600  
Fax no (013) 253-1889  
Fire Dept tel no (013) 253 7643  
Municipal Manager: EK Tshabalala  
Email: tshabalalaek@emakhazeni.gov.za  
Infrastructure, planning, social Development:  
M Mamaleka  
Email: mamalekam@emakhazenilm.co.za  
Deputy Manager: Enforcement, Security  
and Public Safety: VSH Mnisi  
Cell no 072 344 9308  
Email: mnisiv@emakhazenilm.co.za  
Chief Fire Officer: JD Mokoeni  
Tel no (013) 253 7643/ 7630  
Cell no 072 584 5907  
Email: mokonenij@emakhazeni.gov.za  
Chief Traffic Officer: TG Aucamp  
Cell no 083 232 3816  
Deputy Manager: Public Participation  
Coordinator: S Maseko  
Email: masekos@emakhazeni.gov.za  
Size area: 100 km radius  
Population: approx 42 000  
Emergency calls: Grass/Veld fires:64 -  
Building fires:4 - Vehicle accidents:45 -  
Dwelling fires:2 - Others:15  
Value of property destroyed by fire:  
R4 000 000  
Mileage of vehicles per annum: 20 000 kms  
Fire stations: 2 firehouses  
Personnel:- Permanent:3 - Part Time:10 -  
Volunteer fire fighters:6  
Budget: R45 000.00  
*Offices / Fire Stations:*  
*Siyathuthuka Office:*  
Tel no (013) 253 7668  
*Waterval Boven Office:*  
Tel no (013) 253 7680  
*Dullstroom Office:*  
Tel no (013) 253 7687  
*Emthonjeni Office:*  
Tel no (013) 253 7694  
*Entokozweni Office:*  
Tel no (013) 253 7686

**EMALAHLENI LOCAL MUNICIPAL COUNCIL FIRE DEPARTMENT**  
**(Witbank, Kriel, Ogies)**

*Witbank Emergency Services*  
Cnr Beaty and OR Tambo Streets,

Emalahleni  
PO Box 3, Emalahleni 1035  
Switchboard: Tel no (013) 690-6911  
Fax no (013) 690-6380  
Emergency no (013) 690-6222/6333/6444  
Municipal Manager: T Jansen Van Vuuren  
Email: admin@emalahleni.gov.za  
Tel no (013) 690-6911  
Fax no (013) 690-6207  
Chief Fire Officer: PE Khanye  
Tel no (013) 690-6391  
Email: khanyep@emalahleni.gov.za  
Assistant Manager: D Ground  
Tel no (013) 653 5754  
Assistant Disaster Manager: A Magale  
Tel no (013) 653 5758  
Disaster Co-Ordinators: RE Tsuka and  
C Cindi  
Tel no (013) 653 5753  
Snr Divisional Officer: Fire Prevention Officer:  
D Ground  
Tel no (013) 653-5756  
*eMalahleni*  
Snr Divisional Officer: LM Skosana  
Tel no (013) 653 5753  
*Ga-Nala*  
Snr Divisional Officer: S Tsotetsi  
*Phola/Ogies*  
Snr Divisional Officer: JJ Khoza  
Size of area: 2 800 sq kms  
Population: ± 400 000  
Emergency calls :- Rescues:16 - Vehicle  
accidents:247 - Grass/veld fires:88 - Building  
fires:37 - Dwelling fires:33 - Other fires:78 -  
Vehicle fires:97 -  
Value of property destroyed by fire:  
R2 180 000.00  
Budget: Budget: R17 250 000.00

**GOVAN MBEKI MUNICIPALITY**  
**(Secunda, Bethal, Emzinoni, Trichardt, Embalenhle, Evander, Kinross, Thistle Grove, Lebogang, Leandra, Charl Celliers)**

Central business Area Horwood St, Secunda  
Private Bag X1017  
Secunda 2302  
Tel no (017) 620-6000  
Fax no (017) 634 8019  
Email: callcentre@govanmbeki.gov.za  
Executive Mayor: Cllr YT Ngxonono  
Tel no (017) 620-6280  
Fax no (017) 634-5041  
Municipal Manager: Mr. SF Mndebele  
Tel no (017) 620-6279  
Fax no (017) 634-8818  
Head of Communications: BE Soko  
Tel no (017) 620-6254  
Fax no (017) 634-8818  
Email: benzi.s@govanmbeki.gov.za  
Acting Director Community Services: H Van de  
Merwe  
Email: hendrik.v@govanmbeki.gov.za  
Head of Disaster Risk Management:  
VP Dlangalala  
Email: vusi.d@govanmbeki.gov.za  
Chief Fire Traffic: PC Malebye  
Email: phindi.m@govanmbeki.gov.za  
Chief Fire Officer: SS Shabalala  
Email: shelly.s@govanmbeki.gov.za  
Office tel no: (017) 620 6306  
Cell no 082 742 3847  
*Bethal & Emzinoni Fire Stations*  
Acting Senior Station Officer – N Khumalo  
Cell no 082 704 6660

Senior Firefighters:4 - Firefighters 11 - Junior firefighter: 4  
*Secunda Fire Station*  
 Senior Station Officer: D Botha  
 Cell no 076 706 9044  
 Senior firefighter:4 - Firefighter:4 - Junior Firefighter:4  
*Embalenhle Fire Station*  
 Senior Station Officer: D Dhludhlu  
 Cell no 082 682 5917  
 Senior Firefighters:3 - Firefighters:4 - Junior Firefighter: 2  
*Evander Fire Station*  
 Acting Senior Station Officer: T Maseko  
 Cell no 082 745 5428  
*Leandra Fire Station*  
 Senior Station Officer U Funani  
 Cell no 073 475 4040  
 Senior Firefighters:3 - Firefighters:5 - Junior Firefighters:4  
 Size of area: 2958 sq kms  
 Population: 494 538  
 Fire stations: 6  
 Total personnel- 69  
 Emergency calls: Vehicle accidents:261 - Grass/veld fires:331 - Structural fires:78 - Shack fires:95 - Vehicle fires: 23 -Truck fires:6 - Electrical fires:42 - Rescues:3 - Hazmat Incidents:4 - Special service:13 - Fire Fatalities:18 - Accidents Fatalities:67 - Other calls:26  
 Fire prevention inspections:456  
 Building plans:66  
 Value of property destroyed by fire: ±18 million  
 Mileage of vehicles per annum: 99 326 kms

**LEKWA MUNICIPALITY FIRE & RESCUE SERVICE**

**(Standerton, Morgenson)**  
 Cnr Dr Beyers Naude & Mbonani Mayisela Streets, Standerton  
 PO Box 66  
 Standerton 2430  
 Switchboard: (017) 712 9600  
 Fax no (017) 712 6808  
 Municipal Manager: GPN Mhlongo-Ntshangase  
 Tel no (017) 712 9628  
 Email: mbalenhledl@gmail.com / mgovu.com@gmail.com  
 Communications Officer: T Mtshiselwa  
 Tel no (017) 712-9614  
 Fax no (017) 712-6808  
 Chief Disaster Management: NJ Kock  
 Email: nkock@lekwalms.gov.za  
 Tel no (017) 712-1065 ext 104  
 Cell no 082 855 3497  
 Executive Manager: Community Services and Safety: Ms M Radebe  
 Tel: 017 712 1184 / 86 Fax: 017 712 6808  
 Email: mmphuthi@lekwalms.gov.za  
 Size of area: 11 640 sq kms  
 Population: 280 000  
 Emergency calls:- Rescues/Recoveries:123 - Grass/Veld fires:149 - Building fires:90 - Fatalities:17 - Dwelling fires:90 - Hazmat incidents:17 - Fire calls:255 - Motor vehicle accidents: 123 - Motor Vehicle Fire: 16  
 Value property destroyed by fire: R18 785 000.00  
 Mileage of vehicles per annum: 55 000 kms  
 Fire station: 1 - Satellite station:1  
*Standerton Station*  
 Tel no (017) 712-5458

Emergency (017) 712-5551 / (017) 7125458  
 Station Officer: JW Mkhwanazi  
*Morgenzon Sub-Station*  
 Tel/Fax no (017) 793-3520  
 Cell no 079 894 8487  
 Tel no 24 hours (017) 712-5551 / 017 793 3496  
 Fax no (017) 712-6808  
 Station Officer Morgenzon: EJ Le Roux  
 Personnel:- Officers:2 - Full-time Senior Fire-fighters: 2 - vacant position:3 - firefighters:24 - Volunteer fire fighters:0

**MBOMBELA MUNICIPALITY FIRE & RESCUE SERVICES & EMERGENCY SERVICES**

**(Barberton, Nelspruit, White River, Hazeyview, Nsikazi)**  
 150 Henshall Str  
 PO Box 45  
 Nelspruit 1200  
 Switch Board no (013) 759-9111  
 Tel no (013) 759 2129 / 31  
 Fax no (013) 753-3018/9  
 Cell no 082 446 8672  
 Emergency No (013) 753 3331  
 Acting Municipal Manager: N Diamond  
 Email: Nompumelelo.Khumalo@mbombela.gov.za  
 Tel no (013) 759-2231  
 Fax no (013) 759-2274  
 Acting Head of Communications: J Ngala  
 Tel no (013) 759-2180  
 Fax no (013) 759-2331  
 Cell no 071 460-5246  
 Email: joseph.ngala@mbombela.gov.za  
 Chief Fire Officer: P Mthiyane  
 Email: Petrus.Mthiyane@mbombela.gov.za  
 Chief Disaster Management: Mrs L Mkhabela  
 Email: lynciam@mbombela.gov.za  
 Size area: ± 70 000 sq kms  
 Population: ± 600 000  
 Emergency calls:- Rescues: 298 - Grass/veld fires:266 - Building fires:181 - Dwelling fires:75 - Vehicle Accidents:431  
 Fire stations: 3  
 Personnel:- Officers:7 - Full-time fire fighters:52 - Volunteer fire fighters:20 - Dispatchers:10

**MKHONDO MUNICIPALITY FIRE DEPARTMENT**

**(Piet Retief, Amsterdam, Dirkiesdorp)**  
 Municipality: 33 Mark Street Piet Retief  
 PO Box 23  
 Piet Retief 2380  
 Fire Station: Cnr Market & De Wet St, Piet Retief 2380  
 Tel no (017) 826-8100  
 Fax no 086 242 2148  
 Email: info@mkhondo.gov.za  
 Municipal Manager: M Kunene  
 Tel no (017) 826-8101  
 Email: mmabuza@mkhondo.gov.za  
 Chief Fire Officer/Disaster Officer: AH Nortje  
 Cell no 079 872 8989 / 083 494 7540  
 Email: anortje@mkhondo.gov.za  
 Platoon Comander: C Zungu  
 Email: zungurescue@gmail.com  
 Fax no 086 242 2148  
 Chief Traffic Officer: MVG Msibi  
 Cell no 082 977 0307  
 Population: 160 000  
 Size of area: 4868,153 sq kms

Emergency calls:- Rescues/Recovers:97 - Special service calls:62 - Grass/Veld fires:36 - Vehicle accidents:182 - Building fires:37 - Dwelling Fires:46 - Fatalities at Rescues /Recoveries:22  
 Value of property destroyed by fire: R950 000.00  
 Mileage of vehicles per annum: 30 000 kms  
 Personnel:-Chief Fire Officers: - 2 Platoon Commanders- 3 Senior Fireman: - 3 Firemen: - Junior Firemen: 0  
 Budget: R900 000.00

**MSUKALIGWA LOCAL COUNCIL DEPARTMENT OF PUBLIC SAFETY (Breyten, Ermelo, Davel, Lothiar, Chrissiesmeer, Sheepmoor, Warburton, New Scotland)**

Church Str, Ermelo 2350  
 PO Box 48  
 Ermelo 2350  
 Tel no (017) 801-3851  
 Fax no (017) 801-3851  
 Switchboard: 017 801 3500  
 Municipal Manager: GJ Majola  
 Tel no (017) 801-3504  
 Fax no (017) 801-3851  
 Email: gjmajola@msukaligwa.gov.za  
 Head of Communications: MAJ Zwane  
 Tel no (017) 801-3576  
 Fax no (017) 801-3660  
 Cell: 082 809 8296  
 Email: mzwane@msukaligwa.gov.za  
 Director Public Safety: Vacant  
 Tel no (017) 801 3402/5  
 Fax no (017) 801 3424  
 Cell no 082 747 3013  
 Chief Fire Officer: J Johnstone  
 Tel no (017) 801 3402  
 Fax no (017) 801 3424/3417  
 Cell no 072 546 0454  
 Email: jjohnstone@msukaligwa.gov.za  
 Chief Disaster/Security Officer: F Maseko  
 Tel no (017) 801 3412  
 Cell no 071 489 3432 / 083 262 1018  
 Email: fmaseko@msukaligwa.gov.za  
 Chief Traffic Officer: C Enock  
 Tel no (017) 801 3409  
 Cell no 072 311 9833  
 Email: cenock@msukaligwa.gov.za  
 Chief Licensing Officer: CMM Magagula  
 Tel no (017) 801 3430  
 Cell no 083 760 6718  
 Email: mumagagula@msukaligwa.gov.za  
 Fire stations:2 - Substations:2  
*Breyten Sub-Station Section*  
 Breytenbach Str Breyten  
 PO Box 48  
 Ermelo 2350  
 Tel no (017) 819-2472  
 Fax no (017) 819-2472  
 Size of area: 8,0 sq kms  
 Population: 23 000  
 Fire calls per annum: 128  
*Ermelo Fire Section*  
 Cnr Border & Wedgewood Strs 2350  
 PO Box 48  
 Ermelo 2350  
 Tel no (017) 819 2472  
 Fax no (017) 819-2472  
 Size of area: 51 sq kms  
 Population: 83 000  
 Emergency calls :- Accidents:62 - Rescues:22 - Train accidents:3 -

Grass fires:221 - Vehicle fires:6 - Dwelling fires:23 - Building fires:2 - LAPA:1 - Power box:3 - Tyre fires:7 - Garbage fires:12 - Fire alarms:4 - False alarms:9 - Special service:300 - Hazardous incidents:3 - Petrol spill:5 - Petrol & diesel wash aways:8 - Fatalities at fires:2 - Fatalities at rescues:32 - forestry fires 6  
 Value property destroyed by fire: R80 000 000.00  
 Mileage of vehicles per annum: 30 000 kms  
 Personnel:- Officers:2 Full-time fire fighters:17

**STEVE TSHWETE LOCAL MUNICIPALITY FIRE & RESCUE SERVICES (Hendrina)**

Lilian Ngoyi Street  
 PO Box 14  
 Middelburg 1050  
 Switchboard: Tel no (013) 249-7000  
 Fire Dept: Tel no (013) 243-2222 / (013) 249-7222  
 Fax no 086 204 2123  
 E-mail: amashiloane@stevetshwetelm.gov.za  
 Municipal Manager: B Khenisa  
 Tel no (013) 249-7263  
 Fax no (013) 243-2550  
 Email: smmnguni@stevetshwetelm.gov.za  
 Head of Communicatios: P Magutle  
 Tel no (013) 249-7053  
 Fax no (013) 243-2550  
 Cell no 082 338 3821  
 Email: pmagutle@stevetshwetelm.gov.za  
 Chief Fire Services: A Mashiloane  
 Tel no (013) 249-7322  
 Email: amashiloane@stevetshwetelm.gov.za  
 Executive Director: Community Services: C Zulu

Tel no (013) 249-7306  
 Email: czulu@stevetshwetelm.gov.za  
 Disaster Management Officer: LF Monareng  
 Tel no (013) 249-7270  
 Director: Traffic & Security Services: P Nkosi  
 Tel no (013) 249 7030  
 Email: pnkosi@stevetshwetelm.gov.za  
 Size of area: 3 997 sq kms  
 Population: 230 000  
 Emergency calls: Building Fires: 215 - Grass/veld fires: 375 - Vehicle accidents: 1135 - Fatalities at fires: 0 - Fatalities at rescues/recoveries: 100 - Special Services: 121 - Dwelling fires: 109  
 Value property destroyed by fire: R68 000 000.00  
 Mileage of vehicles per annum: 67 000  
 Personnel:- Officers:10 - Fire fighters:42 - Admin:2- Other:3 - Control Room:24 - Contract positions: 4  
*Hendrina Fire Station*  
 Arnot Road, Hendrina  
 Tel no (013) 293-0011  
 Station Officer: K Kleinhans  
 Personnel:- Officers:1 - Fire fighters:12  
 Budget: R35,743,869.000

**THABA CHWEU MUNICIPALITY FIRE DEPARTMENT**

**(Lydenburg, Sabie, Graskop, Pilgrims Rest, Moremela, Leroro, Matibidi)**  
 Cnr Viljoen & Central Str Lydenburg  
 PO Box 61  
 Lydenburg 1120  
 Tel no (013) 235-7300  
 Fax no (013) 235 1108  
 24 hour Emergency and Disaster Management *Control Centre:*  
*Thaba Chweu - Lydenburg*

Tel no (013) 235 1788 / 7370  
*Sabie, Graskop, Moremela, Leroro, Matibidi, Mashishing*  
 Email: lucasmahlake14@gmail.com  
 Municipal Manager: S Matsi (Acting)  
 Email: mm@thabachweumun.gov.za  
 Director Community and Social Services: Ms S Matsi  
 Tel no (013) 235 7300  
 Chief Fire & Emergency Services: P Mkhonto  
 Tel no (013) 235 7300  
 Cell no 082 493 7013  
 Email: pmkhonto@thabachweumun.gov.za  
*Graskop Fire Station*  
 Main Street Graskop  
 PO Box 18  
 Graskop, 1270  
 Station Officer: L Mahlake  
 Cell no 083 459 3248  
*Lydenburg Fire Station*  
 Tel no (013) 235 1788  
 Fax no (013) 235 2227  
 Chief Fire Officer and Disaster management: P Mkhonto  
 Cell no 082 493 7103  
 Email: pmkhonto@thabachweumun.gov.za  
*Sabie Fire Station*  
 6th Avenue, Sabie  
 PO Box 61  
 Lydenburg 1120  
 Fire & Rescue Officer: J Masina  
 Fax no (013) 764 2249  
 Cell no 072 670 3600  
*Thaba Chweu Fire Station*  
 Tel no (013) 235 1788  
 Population: 160 000  
 Size of area: 5500sq kms

**NORTHERN CAPE**

**DAWID KRUIPER MUNICIPALITY FIRE & RESCUE (Upington, Mier)**

Cnr Anton Lubowski & Dakota Rd  
 Upington  
 Private Bag X6003  
 Upington 8800  
 Tel no (054) 338 7405  
 Fax no (054) 332-4524  
 Municipal Manager: E Ntoba  
 Tel no (054) 338 7001  
 Fax no (054) 332 4526  
 E-mail: manager@kharahais.gov.za  
 Manager of Communications: P Williams  
 Tel no (054) 338-7008  
 Fax no (054) 338-7350  
 Email: communications@kharahais.gov.za  
 Director Community Services: MG Bovu  
 Tel no (054) 338 7047  
 Fax no (054) 331 1857  
 Cell no 076 672 3484  
 Email: devsec@kharahais.gov.za  
 Manager Fire & Disaster Management: J De Monk  
 Tel no (054) 338 7401  
 Fax no (054) 332-4526  
 Cell no 082 335 8642 / 084 299 8466  
 Email: fire@kharahais.gov.za  
 Manager Traffic: WCJ Andrews

Tel no (054) 338 7421  
 Fax no (054) 332 1563  
 Email: trafficadmin@kharahais.gov.za  
 Manager Security Services: G Titus  
 Tel no (054) 3387174  
 Fax no (054) 332 1870  
 Email: sekadmin@kharahais.gov.za  
 Size of area: 471 769 sq kms  
 Population: 100 000  
 Emergency calls:- Rescues:151 - Recoveries:11 - Grass/Veld fires:104 - Building fires:44 - Vehicle fires:61 - Others:88 - Special service calls:311  
 Risk: R4,5 million  
 Mileage of vehicles per annum: 12 000 kms  
 Personnel:- Officers:2 - Full-time fire fighters:18 - Disaster Management Assistant:2 - Control Room Officials:8 - Other staff:4  
 Budget: R48 000 000.00

**EMTHANJENI MUNICIPALITY (De Aar, Hanover, Britstown)**

45 Voortrekker St, De Aar  
 PO Box 42  
 De Aar 7000  
 Tel no (053) 632-9100  
 Fax no (053) 631-0105  
 Fire Brigade tel no: 082 904 8614 / 8543/ 8517

Emergency / After hours tel no: 082 887 4024 / 20 / 28  
 Municipal Manager: I Visser  
 Cell no 082 802 2319  
 Email visser@emthanjeni.co.za  
 PA to MM: T Salman  
 Director Corporate Services: T Msengana  
 Email: tmsengana@emthanjeni.co.za  
 Supt Traffic Officer: A Bourcher  
 Chief Traffic Officer: XG Stonga  
 Tel no (053) 632-9100  
 Email: xsthonga@emthanjeni.co.za  
 Email: mayor@emthanjeni.co.za  
 Size of area: 13 000 sq kms  
 Emergency calls:26  
 Fire stations: 2  
*Hanover Fire Station:*  
 Tel no (053) 643-0026  
*Britstown Fire Station:*  
 Tel no (053) 672-0202  
 Personnel:- Volunteer Fire fighters:11

**GAMAGARA MUNICIPALITY (Kathu)**

Cnr Hendrik Van Eck & Frikkie Meyer Road,  
 Kathu, 8446  
 PO Box 1001  
 Kathu 8446  
 Tel no (053) 723-6000

Fax no (053) 723-2021  
Email: info@gamagara.gov.za  
Municipal Manager: C Itumeleng  
Email: clementi@gamagara.co.za  
Chief Disaster Manager: G Loeto  
Cell no 082 368 3839  
Chief Fire Officer: P Moolman  
Email: paulm@gamagara.co.za

**GA-SEGONYANA MUNICIPALITY FIRE DEPARTMENT**

**(Batharo Ba Ga Motlhwane, Ga Mohana, Gathlose, Kudumane, Kuruman Part 1, Kuruman Part 2, Mothibistad)**

Cnr Voortrekker & School Str Kuruman  
Private Bag X1522  
Kuruman 8460  
Tel no (053) 712-9300  
Fax no (053) 712-3581  
Fire Emergency tel no: 083 448 9223  
Email: kurmun@ga-segonyana.gov.za /  
/ registry@ga-segonyana.gov.za  
Municipal Manager: E Ntefang  
Tel (053) 712-9301  
Email: ntefang@ga-segonyana.gov.za  
Head of Corporate Services: M Tsatsimpe  
Tel no (053) 712-9302  
Cell no 082 727 3823  
Email: tsatsimpe@ga-segonyana.gov.za  
Chief Traffic Officer: L Lungile  
Director Community Services:  
P Sampson  
Deputy Director Community Development:  
P Sampson  
Disaster Management Officer: T Moshweu  
Size of area: 91 4 sq kms  
Emergency calls: 8  
Personnel:- Volunteer fire fighters:14  
Mileage of vehicles per annum: 500 kms  
Budget: R135 541.00

**KAI! GARIB MUNICIPALITY FIRE DEPARTMENT**

**(Kakamas, Keimoes, Kenhardt)**  
9 11th Ave Kakamas  
Private Bag X6  
Kakamas 8870  
Tel no (054) 461 6700  
Fax no (054) 431 6338  
Municipal Manager: G Lategan  
Tel no (054) 431 6328  
Email: mm@kaigarib.gov.za  
Director Planning and Development: J MacKay  
Tel no (054) 461 6406  
Email: mackayj@kaigarib.gov.za  
Director Technical Services: M Clarke  
Tel no (054) 461 6309  
Email: clarkem@kaigarib.gov.za  
Personnel:- Fire fighters:1  
*Keimoes Substation*  
Hoos St Keimoes  
PO Box 8  
Keimoes 8860  
Tel no (054) 461 6700  
*Kenhardt Office*  
Tel no (054) 651 6500

**NAMAKWA DISTRICT MUNICIPALITY FIRE DEPARTMENT**

Van Riebeeck Str Springbok  
Private Bag X 20  
Springbok 8240  
Tel no (027) 712-8000  
Fax (027) 712-8040

Email: info@namakwa-dm.gov.za  
Municipal Manager: C Fortuin  
Tel no (027) 712 8000  
Fax no (027) 712 8040  
Email: chrisf@namakwa-dm.gov.za  
Senior Disaster Fire and Incident  
Manager: LJ Vermeulen  
Tel no (027) 712 8000  
Cell no 084 511 7481  
Fax no (027) 712 8040  
Email: leonv@namakwa-dm.gov.za  
Senior Disaster Fire and Incident  
Manager: C Nero  
Tel no (027) 712 8000  
Cell no 074 922 1331  
Fax no (027) 712 8040 / 086 484 9772  
Email: neelsn@namakwa-dm.gov.za  
*Nama Khoi Municipality Fire Department*  
4 Namakwa Str Springbok  
PO Box 17 Springbok 8240  
Tel no (027) 718 8100  
Fax no (027) 712 1635  
After hours emergency Cell: 079 924 3092 /  
082 899 6766  
Municipal Manager: S Titus  
Tel no (027) 718 8100  
Cell no 082 899 6684  
Fax no (027) 712 1635  
Email:  
municipal.manager@namakhoi.gov.za  
Fire and Disaster Management Officer:  
V Swartbooi  
Tel no (027) 718 8106  
Cell no: 082 899 6923  
Fax no 086 486 0246  
E-mail: vernon.swartbooi@namakhoi.gov.za

**SIYATHEMBA MUNICIPALITY FIRE DEPARTMENT**

**(Prieska, Marydale, Niekershoop)**  
Victoria Str Prieska  
PO Box 16  
Prieska 8940  
Tel no (053) 353-5300 (a/h) 084 991 6740  
Fax no (053) 353-1386  
Email: mmsec@siyathemba.gov.za  
Municipal Manager: IJJ Stahouer  
Fire / Technical Manager: J Basson  
Email: jakobbasson@yahoo.com  
Tel no (053) 353-5312  
Fax no (053) 353 1386  
Cell no 082 804 2374  
Chief Traffic Officer: Vacant  
Tel no (053) 353 5327  
Chief Disaster Management: JJ Badenhorst  
Size of area: 175 sq kms  
Population: ± 17517  
Emergency calls: 0  
Mileage of vehicles per annum: 120 kms  
Personnel:- Fire fighters:12  
Budget: R498 500.00  
*Marydale Fire Station*  
Van Wyk Str Marydale  
PO Box 33 Marydale 8910  
Tel no (054) 871-0007  
Fax no (054) 871-0035

**SOL PLAATJIE MUNICIPALITY EMERGENCY SERVICES**

**(Kimberley)**  
21 Lyndhurst Rd Kimberley  
PO Box 1532  
Kimberley 8300  
Emergency Tel no (053) 832-4211/2/3/4/5

(053) 832-2222  
Tel no (053) 832 4214/5  
Fax no 086 536 4721  
City Manager: GH Akharwaray  
Tel no (053) 830-6100  
Senior Manager: Emergency Services (&  
Disaster Management) MW Pretorius  
Cell no 082 415 6010  
Tel no (053) 832-4233  
Fax no 086 536 4721  
Email: mpretorius@solplaatje.org.za  
Manager: Emergency Services:  
R Janse van Vuuren  
Cell no 082 415 5817  
Email rjvuuren@solplaatje.org.za  
Senior Manager Traffic Services:  
CFM Langford  
Tel no (053) 831-4348  
Size area: ± 1876.92 sq kms  
Population: ± 350 000  
Value of area: ± R2 billion  
Emergency calls: 1300  
Value of property destroyed by fire:  
R1 120 000.00  
Fire stations: 3 plus one seasonal  
Fire fighters: 87

**THEMBELIHLE MUNICIPALITY FIRE DEPARTMENT**

**(Hopetown, Strydenburg)**  
Church Str Hopetown  
Private Bag X3  
Hopetown 8750  
Tel no (053) 203-0008/5  
Fax no (053) 203-0490  
Fire Brigade Tel no (053) 203 0951  
Email:  
cmogalie@thembelihlemunicipality.gov.za  
Municipal Manager: M Mogale  
Email:  
mmogale@thembelihlemunicipality.gov.za  
Corporate Services Manager: M Mguye  
Technical Services Manager: S Marufu  
Email:  
smarufu@thembelihlemunicipality.gov.za  
Size of area: 60 sq kms  
Population: 15 000  
Emergency calls:- Vehicle accidents:49 -  
Dwelling fires:2 - Industrial fires:1 -  
Vehicle fires:2  
Value of property destroyed by fire:  
R2 000 000.00  
Mileage of vehicles per annum: 85kms  
Personnel:- Part-time fire fighters:0

**TSANTSABANE MUNICIPALITY FIRE DEPARTMENT**

**(Postmasburg)**  
13 Springbok Str Postmasburg  
P O Box 5  
Postmasburg 8420  
Tel no (053) 313-7300  
Fax no (053) 313-1602  
Emergency Services: Tel no (053) 313 7331  
Fire: Tel no (053) 311 6666  
Email: mm@tsantsabane.gov.za  
Municipal Manager: GH Mathobela  
Director Community Services:  
J Theys  
Email: julius.theys@tsantsabane.gov.za  
Traffic / Fire Officer: D Louw  
Tel no (053) 313-7300  
Fax no (053) 313-0353  
Email: dlo@live.co.za

**UMSOBOMVU MUNICIPALITY FIRE DEPARTMENT**

**(Colesberg, Noupoot, Norvalspont)**  
21A Church St Colesberg  
Private Bag X6  
Colesberg 9795  
Tel no (051) 753-0777

**BOJANALA PLATINUM DISTRICT MUNICIPALITY**

**(Rustenburg)**  
Cnr Fatima Bhayat & Beyers Naude  
Rustenburg  
PO Box 1993  
Rustenburg 0300  
Tel no (014) 590-4500  
Email: info@bojanala.gov.za  
Municipal Manager: P Shikwane  
Tel no (014) 590-4502  
Fax no (014) 597 0306  
Email: pogisos@bojanala.gov.za /  
tsholofelod@bojanala.gov.za  
Head of Communications: A Babelle  
Tel no (014) 590-4531  
Fax no (014) 592-6085  
Acting Director Community Development  
Services: G Mahlangu  
Tel no (014) 592 4303  
Email: gladyss@bojanala.gov.za  
Head District Disaster Management:  
G Mahlangu  
Tel no (014) 592 6321 / 4495  
Fax no (014) 592 4393  
Cell no 083 639 8750  
Email: gladyss@bojanala.gov.za  
Manager Fire & Rescue Services:  
PL Dirapelo  
Telefax no (014) 543 4537  
Cell no 082 351 1734  
Email: dirapelo.pat@gmail.com  
*Koster sub-station*  
4 Patent Street, c/o Patent & Robinson,  
Koster  
Chief Fire Officer: PDS Mosito  
Telefax no (014) 543 4537  
Cell no 082 351 1734  
Email: dirapelo.pat@gmail.com  
Assistant Chief Fire Officer: AM Mphahlele  
Cell no 082 432 1546  
Email: thusgun@vodamail.co.za  
*Mogwase sub-station*  
No 2 Second Street, Bodirelo Industrial  
Township,  
Chief Fire Officer: FJ Mogale  
Telefax no (014) 558 2779  
Cell no 083 315 9918  
Assistant Chief Fire Officer: NF Tsitsi  
Cell no 073 172 6272  
Email: mmudubu@gmail.com  
*Moretele Fire Station*  
Moretele office Park, Makapanstad  
Chief Fire Officer: RR Motshegwa  
Cell no 083 458 3262  
Fax no 086 618 0836 / (012) 714 3938  
Assistant Chief Fire Officer: DS Khunou  
Cell no 072 618 0939  
Email: blackrhinosec@vodamail.co.za  
Emergency calls per annum: Rescues/RTA  
recoveries:77 - Special service calls:49 -

Fax no (051) 753-0574  
Manager: Corporate Services: BJ Kapp  
Email: birtus@umsobomvumun.co.za  
Section Head: Community Development  
Services: G Mgcineni  
E-mail:  
gmgcineni@umsobomvumun.co.za

Municipal Manager: AC Mpela  
Email: mpela@umsobomvumun.co.za  
HR Officer: C Asiya  
Email: clifford@umsobomvumun.co.za  
Chief Fire Officer / Traffic Officer:  
CT Pasmeni  
Cell no 084 286 1134  
Personnel: Resevists:2

# NORTH WEST

Grass/veld fires:39 - Other Fire: 39 - Dwelling  
fires:40  
Mileage of vehicles per annum: 365 790 kms

**DITSOBOTLA LOCAL MUNICIPALITY FIRE DEPARTMENT**

**(Lichtenburg, Coligny, Itsoseng)**  
Cnr Nelson Mandela Dr & Transvaal St  
Lichtenberg  
PO Box 7  
Lichtenburg 2740  
Tel no (018) 633 3800  
Regional control centre no (018) 632-1474  
Municipal Manager: L Ralekgetho  
Tel no (018) 632-3800  
Email: info@ditsobotla.gov.za  
Divisional Fire Officer: GG Kwena  
Tel: 018 381 9400/55  
Cell: 083-468-5884  
Email: kwenag@nmdm.gov.za  
Population: ± 200 000  
Emergency calls: Grass/Veld fires:67 - Vehicle  
accidents/rescues:11 - Dwelling fires:7 -  
Others:10 - Special services:15 - Other  
buildings:8 - Rescue false alarms (good  
intent):51 - False alarms:5  
Personnel:- Officers:32 - Fire fighters:3 -  
Other staff:2 - Volunteers:1  
*Coligny substation*  
Tel no (018) 632 1474  
*Itsoseng substation*  
Tel no (018) 338 1007

**DR RUTH S MOMPATI DISTRICT MUNICIPALITY**

**(Lekwa-Teemane, Greater Taung, Kagisano/Molopo, Mamusa)**  
50 Market Str Vryburg  
PO Box 21  
Vryburg 8600  
Tel no (053) 928 4700  
Fax no (053) 927-2401  
E-mail: keoagileo@bophirima.co.za  
Acting Municipal Manager: J Mononela  
Email: mononelaj@bophirima.co.za  
Manager Fire & Disaster Management:  
H Bezuidenhout  
Tel no (053) 927-3235  
Fax no (053) 927-3256  
Email: bezuidenhouth@bophirima.co.za  
Heads of Fire Stations:  
*Mamusa: D/O Moheta*  
Cell no 072 628 2786  
*Lekwa-Teemane: D/O Tong*  
Cell no 079 821 3634  
*Kagisano / Molopo: D/O Mabila*  
Cell no 076711 8976  
*Greater Taung D/O M Picoyakgosi*  
Cell no 084 784 8672  
Head: Ambulance: M Mothupi  
Tel no (053) 927 0456

Disaster Management: M Ikaneng  
Cell mo 072 828 9210  
Fire Prevention: D/O Godhlo  
Cell no 072 333 9591

**KGETLENG RIVIER MUNICIPALITY**

**(Koster, Derby, Swartruggens)**  
Cnr De Wet & Smuts Strs Koster  
PO Box 66  
Koster 0348  
Fire Department tel no (014) 543 4537  
Tel no (014) 543-2004  
Fax no (014) 543 4086 /2480  
Email jdubruy@kgetlengrivier.gov.za  
Acting Municipal Manager: TB Mothogoane  
Email: info@kgetlengrivier.gov.za  
Director Community Services: R Mavhungu  
(Acting)  
Email: mavhungur@kgetlengrivier.gov.za  
Population: 38 000  
Size of area: 5320 sq kms  
Emergency calls: 25  
Value of property destroyed by fire:  
R7 500.00  
Mileage of vehicles per annum 39 kms  
Personnel:- Fire fighters:5

**JB MARKS MUNICIPALITY - DEPARTMENT PUBLIC SAFETY FIRE BRIGADE SERVICES SECTION**

Cnr Luiting & Poortman Strs Industria  
Potchefstroom  
PO Box 113  
Potchefstroom 2520  
Tel no (018) 299-5343  
Fax no (018) 293-1113  
Emergency no (018) 293-1111/2/22  
Manager Public Safety: LJ Nkhumane  
Tel no (018) 299-5341  
Cell 079 2577 686  
E-mail: lesiban@tlokwe.gov.za  
Chief Fire Officer: DI Semase  
Tel no (018) 299 5343 /49  
Cell 083 438 3266  
Fax no 086 212 9375  
E-mail : ditabas@tlokwe.gov.za  
Fire Training Centre Co-ordinator:  
SJ Mahlangu  
Tel no (018) 299 5374 / 5343  
Email: johannesm@tlokwe.gov.za  
Asst Chief Fire Officer: Fire Brigade Services:  
AJ Booysen  
Tel no (018) 299 5343/5811  
Cell 079 949 5599  
Email: attieb@tlokwe.gov.za  
Divisional Officer Fire Safety: S Mabena  
Tel no (018) 299 5343  
Cell no 078 143 9608  
Fax no 086 771 7981  
Email: surprisem@tlokwe.gov.za  
Divisional Officer Operations: PL Pretorius

Tel no (018) 299 5343  
 Cell no 083 755 5233  
 Email: leroypt@tlokwe.gov.za  
 Security Manager: MISS: TS Maluleke  
 Tel no (018) 299 5396  
 Cell no 072 952 0556  
 Fax no 086 664 0813  
 Head Disaster Management Centre:  
 VT Khupari  
 Tel no (018) 299 5540  
 Cell no 073 218 0204  
 Email: thabok@tlokwe.gov.za  
 Disaster Management Public Awareness  
 Officer: T Moumakwa  
 Tel no (018) 299 5810  
 Cell no 071 111 4958  
 Email: TMoumakwa@tlokwe.gov.za  
 Crisis Control Officer (Disaster  
 Management): N Jakole  
 Tel no (018) 299 5826  
 Cell no: 083 670 2568  
 Email: nkosinathij@tlokwe.co.za  
 Occupational Health & Safety Officer:  
 A Ntlhane  
 Tel no (018) 299 5219  
 Dispatch Centre Enquiries:  
 Tel no (018) 299-5347  
 On-duty Station Officers:  
 Tel no (018) 299-5348  
 Size of area: 6 434.66 sq kms  
 Population: 301 396  
 Emergency calls: Rescues/Recoveries:154 -  
 Aviation:0 - Animal in distress:7 - Structural  
 Collapse:0 - Sewer:0- MVA:139 - Water  
 Rescues:6 - Other:0 - Fires:950 - Grass/Veld  
 fires:625 (162 Fire Breaks prepared) -  
 Building fires:12 - Dwelling fires:228 (132  
 informal housing) - Vehicle fires:56 - Other:29  
 - Vehicle accidents:512 - Special Services:  
 228 - Assist families during disasters:53 -  
 Management of events:32- Hazmat  
 Incidents:0 - Other Special services:41  
 Value of property destroyed by fire:  
 R107 000 000.00  
 Mileage of fire vehicles per annum:  
 32 390 kms  
 Personnel: Management:2 - Fire  
 Operational:33 - Fire Safety:3 - Training:2 -  
 Volunteer:44 - Reservist fire fighters:16

**LEKWA-TEEMANE LOCAL MUNICIPALITY  
 FIRE DEPARTMENT  
 (Bloemhof, Christiana)**

Cnr Dirkie Uys & Robyn St Christiana  
 PO Box 13  
 Christiana 2680  
 Tel no (053) 441-2206/3952  
 Fax no (053) 441-3735  
 Email: registry@lekwa-teemane.co.za  
 Municipal Manager: T Leslie  
 Tel no (053) 441 2206/7/8  
 Email: lesiet@lekwa-teemane.co.za  
 Director: Corporate Services: O Letebele  
 Tel no (053) 433 1018  
 Cell no 082 302 9470  
 Email: letebeleo@lekwa-teemane.co.za  
 Director Community Services: T Leslie  
 Tel no (053) 443 1018  
 Cell no 082 719 0331  
 Email: lesiet@lekwa-teemane.co.za  
 Divisional Officer: MG Tong  
 Dr. RSM District Municipality  
 Cell no 079 821 3634

**MADIBENG LOCAL MUNICIPALITY FIRE  
 DEPARTMENT  
 (Brits)**

Cnr Hendrik Verwoerd and Crocodile Str,  
 Brits  
 PO Box 106  
 Brits 0250  
 Tel no (012) 250 2222  
 Fax no (012) 250 1221  
 Cell no 083 228 2784  
 Emergency no - 24 hours (012) 250-2222 /  
 250-2127  
 Municipal Manager: G Magole  
 Email: munman@madibeng.gov.za  
 Tel no (012) 318 9212  
 Public Safety and Social Services: P Dilinga  
 Tel no (012) 318 9410  
 Chief Traffic Officer: AW Januarie  
 Email andrewjanuarie@madibeng.gov.za  
 Chief Fire Officer: G Mafatlhe  
 Tel no (012) 250 2222  
 Email: Gordon.mafatlhe@telkomsa.net  
 Head Disaster Management Centre: P  
 Dilinga  
 Email: Pumla.Dilinga@madibeng.gov.za  
 Size of area: 3832 sq kms  
 Population: 342799  
 Emergency calls: 455  
 Total mileage of vehicles per annum:  
 22 000 kms  
 Personnel:- Fire fighters:25  
 Satellite Station: Lethlabile  
 Personnel:- Firefighters:30 - Volunteers:15

**MAMUSA MUNICIPALITY FIRE  
 DEPARTMENT  
 (Schweizer-Reneke)**

28 Schweizer Str Schweizer-Reneke  
 PO Box 5  
 Schweizer-Reneke 2780  
 Fire station: Corner Swart and Buiten Street,  
 Schweizer-Reneke  
 Tel no (053) 963-1331  
 Fax no (053) 963-2474  
 Municipal Manager: MJ Ratlhogo  
 Email: ratlhogom@mamusalm.gov.za  
 Manager of Communications: J Maine  
 Cell no - 072 151 9127  
 Email: mainej@mamusalm.gov.za  
 Director Technical Services: T Marumole  
 Cell no 072 117 5467  
 Email: marumolet@mamusalm.gov.za  
 Community Services Manager: ED Mokoma  
 Cell no 082 374 6467  
 Email: mokomae@mamusalm.gov.za  
 Manager Ambulance : Mrs R Maseng  
 Cell no 083 437 7540  
 Size of area: ±100 sq kms  
 Population: ± 70 000  
 Emergency calls:- Grass/veld fires:7 -  
 Building fires:2 - Ambulance: 1750  
 Mileage of vehicles per annum: 5 000 kms  
 Mileage of ambulances per annum:  
 95 000 kms  
 Fire stations/store: 1  
 (Cnr Pauw & Cameron Str)  
 Personnel:- Volunteer firefighters:11-  
 Ambulance attendants:2 - Other staff:1  
 Budget: Fire: R109 024.00  
 Ambulance: R582 470.00

**MAQUASSI HILLS LOCAL MUNICIPALITY/  
 PUBLIC SAFETY DIVISION  
 (Volmaransstad, Leeudoringstad,  
 Makwassie, Witpoort)**

21 Fell Str Wolmaransstad  
 Private Bag X3  
 Wolmaransstad 2630  
 Fire Department tel no (018) 596 2546  
 Disaster Management tel no (018) 406 7000  
 Stand by cell no 083 320 0133  
 E-mail: barista1511@gmail.com  
 Municipal Manager: S Lehloenya  
 Tel no (018) 596-1064  
 Email: admin@maquassihills.org  
 Head of Communications: S Lehloenya  
 Divisional Head Public Safety & EMS/Traffic:  
 S Mokoto  
 Divisional Head Community Services: BV  
 Sebekedi  
 Tel no (018) 596 1064  
 Size of area: 4644 sq kms  
 Population: 108 000  
 Fire calls: 10  
 Mileage of vehicles per annum: 600 kms  
 Fire fighters: 4  
 Fire stations: 2  
 Leeudoringstad sub-station  
 51 Paul Kruger Str Leeudoringstad  
 Private Bag X3  
 Wolmaransstad  
 Tel no (018) 596 1064  
 Fax no (018) 596 1555

**CITY OF MATLOSANA FIRE DEPARTMENT  
 (Klerksdorp, Orkney, Hartebeesfontein,  
 Stilfontein)**

**Klerksdorp Fire Department**  
 Cnr Viljoen & Voortrekker Strs Klerksdorp  
 PO Box 99  
 Klerksdorp 2570  
 Tel no (018) 464-8027 / 8060 / 8029  
 Fax no (018) 462-9648  
 Email: ljaca@klerksdorp.org  
 Municipal Manager: TSR Nkhumise  
 Tel no (018) 487-8009  
 Fax no (018) 462 1652  
 Cell no 082 658 1525  
 Email: dnkosi@klerksdorp.org  
 Head of Communications: N Makgetha  
 Tel no (018) 487-8567  
 Fax no (018) 464-1780  
 Email: ntwaki@klerksdorp.org  
 Acting Chief Fire Officer/Disaster Manager:  
 PS Mpato  
 Tel no (018) 464 8046  
 Fax no (018) 462 9648  
 Cell no 082 403 9124  
 Email: smpato@klerksdorp.org  
 Divisional Officer Fire Safety: PS Mpato  
 Email: smpato@klerksdorp.org  
 Tel no (018) 464 8030  
 Cell 082 403 9124  
 Divisional Officer Operations:  
 I Eggberry  
 Email: leggberry@klerksdorp.org  
 Cell no 082 672 6601  
 Divisional Officer: Control room: W Nortje  
 Email: wnortje@klerksdorp.org  
 Tel no (018) 464 8020  
 Cell no 076 868 5712  
 Senior Disaster Officer: LW Mothupi  
 Email: wmothupi@klerksdorp.org  
 Tel no (018) 464 8052

Fax no (018) 462 9648  
 Cell no 073 553 5115  
 Station Officer Operations Officer:  
 SE Thakamakhoa  
 Email: ethakamakhoa@klerksdorp.org  
 Cell no 072 584 7634  
 Station Officer Operations: W Van Zijl  
 Tel no (018) 464 8046  
 Fax no (018) 462 9648  
 Cell No 083 287 5302  
 Email: wvanzijl@klerksdorp.org  
 Station Officer: Fire Safety: M Mmusi  
 Tel no (018) 464-8050  
 Cell no 083-981-4870  
 Email: mmmusi@klerksdorp.org  
 Platoon Commander Fire Safety: M Kruger  
 Tel no (018) 464-8076  
 Cell no 073 184 7881  
 Email: mkruger@klerksdorp.org  
 Platoon Commander Fire Safety: RC Mpato  
 Email: rmpato@klerksdorp.org  
 Tel no (018) 464 8025  
 Cell no 073 184 7881  
 P O Box 1404  
 Klerksdorp 2570  
 Size of area: 3652 sq kms  
 Population: 518 000  
 Emergency calls:- Fire suppressions: 249 -  
 Grass/Veld fires:283 - Building  
 Inspections:842 - Vehicle accidents:137 -  
 Pre burns : 7  
 Mileage of vehicles per annum: 189 650 kms  
 Fire stations: 3  
 Orkney Sub-station  
 Kingsley Ave, Orkney  
 Tel no (018) 473-9524  
 Hartebeesfontein Sub-Station  
 Voortrekker Street  
 Tel no (018) 431 0357 ext 219  
 Personnel:- Officers:7 - Full-time fire  
 fighters:48  
 Budget: R15 512 600

**NGAKA MODIRI MOLEMA DISTRICT  
 MUNICIPALITY  
 Fire & Rescue Services Unit**

Modiri Molema Rd, Mafikeng  
 Private Bag X2167  
 Mafikeng 2745  
 Switchboard: 018 381 9400  
 Fax no (018) 381 4300  
 Cell no 083 468 5884  
 Municipal Manager: MD Dambuza (acting)  
 Tel no (018) 381-9405  
 Fax no (018) 381-4300  
 Email: municipalmanager@nmmdm.gov.za  
 Manager Communications: L Matsose  
 Tel no (018) 381-9424  
 Chief Fire Officer: AK Appolos  
 Tel no (018) 381 9455 / 8069  
 Fax no 086 613 9485  
 Cell no 083 377 6545  
 Email: appolosa@nmmdm.gov.za  
 Assistant Chief: Fire Safety: GG Kwena  
 Cell no 083 352 5847  
 Unit Manager: Fire & Rescue Services:  
 GG Kwena  
 Tel no (018) 381 9400/55  
 Email: kwenag@nmmdm.gov.za

**RAMOTSHERE MOILWA LOCAL  
 MUNICIPALITY**

Lehurutshe Fire Station  
 Mangope Highway  
 Private Bag x 2015  
 Lerato, 2880  
 Email: info@ramotshere.gov.za  
 Fire Dept Tel no (018) 363 3978  
 Emergency no (018) 363 3977 / 8  
 Switchboard no (018) 642 1081  
 Fax no (018) 363-3172  
 Cell no 083 284 7238  
 Municipal Manager: AS Ahmed  
 Email: neo.sebogodi@ramotshere.gov.za  
 Tel no (018) 018-642-1081 ext 202  
 Fax no (018) 642-6175  
 Community Development Services: T Seleka  
 Email: info@ramotshere.gov.za  
 Chief Fire officer: AK Appolos  
 Email: appolosa@nmmdm.gov.za  
 Assistant Chief Fire Officer: MC Modisa  
 Tel no (018) 363 3977  
 Cell no 078 098 9320  
 Email: modisam@nmmdm.gov.za  
 Size area: ± 16 720 sq kms  
 Population: ± 160 000  
 Emergency calls: 50  
 Personnel:- Volunteers:8

**RUSTENBURG LOCAL MUNICIPALITY  
 FIRE DEPARTMENT**

Cnr Nelson Mandela & Bethlehem drive,  
 Rustenburg  
 PO Box 16  
 Rustenburg 0300  
 Municipality: Tel no (014) 590-3111  
 Tel no (014) 590-3232 / 3333 / 4  
 Fax no (014) 597-3924  
 Email: fire@rustenburg.gov.za /  
 Imekgwe@rustenburg.gov.za  
 Municipal Manager: N Sithole  
 Head of Communications: M Matebesi  
 Unit Manager: Emergency & Disaster  
 Management: BE Mfolwe  
 Cell no 083 274 3745  
 Email: emfolwe@rustenburg.gov.za  
 Divisional Commander: Fire Safety &  
 Training: DS Setshedi  
 Cell no 064 757 4989 / 083-346-3653  
 Email: ssetshedi@rustenburg.gov.za  
 Divisional Commander Operations : BO  
 Setshogoe  
 Cell no 064-753-5208 / 076 716 1258  
 Email: osetshogoe@rustenburg.gov.za  
 Section Manager: FJ Heystek  
 Cell no 083 377 5074  
 Email: disaster@rustenburg.gov.za  
 Disaster Management Co-ordinator: JG Phiri  
 Cell No 076 028 2747  
 Email: gphiri@rustenburg.gov.za  
 Director: Public Safety: S Kotsedi  
 Cell no 082 261 1735  
 Email: skotsedi@rustenburg.gov.za /  
 evokazi@rustenburg.gov.za  
 Size of area: 3 300 sq kms  
 Population: 910 000  
 Emergency calls: 1942 - Grass/Veld fires:909  
 - Special services:842 - Motor Vehicle  
 Accidents:1619 - Structural / Building /

Dwelling fires:307 - Fatalities:27 - Others  
 fires:1525  
 Value of property destroyed by fire:  
 ± R7 320 000.00 - R9 875 000.00  
 Mileage of vehicles per annum: ±9994 kms  
 Fire stations: 1  
 2 x Substations (Phatsima & Marikana)  
 Personnel:57 - Officers:6 - Full-time  
 firefighters:42 - Volunteer Fire fighters:48 -  
 Other staff: 6 - Personnel for substations:86  
 Budget: Opex: R29 520 973  
 Capex: R14 378 244.00

**TSWAING LOCAL MUNICIPALITY  
 (Delareyville, Sannieshof, Ottosdal)**

PO Box 24  
 Delareyville 2770  
 Tel no (053) 948-0900 / 9400  
 Fax no (053) 948-1500  
 Fire Department: Tel no: (053) 948 1666  
 Acting Municipal Manager: MD Morwe  
 Email: info@tswaing.gov.za  
 Disaster Management:  
 Tel no (053) 948-9400 ext 9416  
 Assistant Fire Chief: M Chuma  
 Disaster Management Officer: M Lesenyego  
 Community Services Director: S Mokgetho  
 Size of area: ± 450 sq kms  
 Population: 300 000  
 Emergency calls: - Grass/veld fires:110 -  
 Building fires:22  
 Personnel:- Part time firefighters:6 - Full time  
 ambulance personnel:6  
 Sannieshof Fire Station  
 Generaal De La Rey Str Sannieshof  
 PO Box 19  
 Sannieshof 2760  
 Tel no (018) 683-0019  
 Fax no (018) 683-0642  
 Ottosdal sub-station  
 Voortrekker Str Ottosdal  
 PO Box 57  
 Ottosdal 2610  
 Tel no (018) 871-0002  
 Fax no (018) 571-0448

**VENTERSDORP FIRE DEPARTMENT  
 (JB MARKS MUNICIPALITY)**

35 Wolmarans St, Potchefstroom, 2531  
 Private Bag X1010  
 Ventersdorp 2710  
 Tel no (018) 299 5111  
 Ventersdorp Fire Department  
 Tel no (018) 264 8534  
 Fax no (018) 264-8567/2052  
 Ventersdorp Disaster Management:  
 Tel no (018) 264 8534  
 After hours (071) 860 7619  
 Potchefstroom Fire Department  
 Tel no (018) 293 1111  
 Potchefstroom Disaster Management  
 Tel no (018) 299 5347

# WESTERN CAPE

## **BEAUFORT WEST LOCAL MUNICIPALITY FIRE DEPARTMENT**

01 Loch Street Beaufort West  
Private Bag X582  
Beaufort West 6970  
Switchboard: Tel no (023) 414-8100 /8176/4464  
Fire Department: Tel no (023) 414 8176 / 073 099 0508  
Emergency no 10177  
Fax no (023) 415 1373  
Email: admin@beaufortwestmun.co.za  
Municipal Manager: K Haarhoff (Acting)  
Senior Fire Fighter: B Motsoane  
Email: fire@beaufortwestmun.co.za  
Manager Corporate Services: AC Makendlana  
Acting Director Community Services: R. Klink  
Emergency calls: 24  
Personnel:- Firefighters:11

## **BERGRIVIER LOCAL MUNICIPALITY FIRE DEPARTMENT**

### **(Piketberg, Porterville, Velddrif, Aurora, Redelinghuys, Eendekuil)**

Church Str Piketberg  
PO Box 60  
Piketberg 7320  
Tel no (022) 913-6000 / (022) 433 8700  
Fax no (022) 913-1406  
Municipal Manager: H Linde  
Email: mm@bergmun.org.za/  
bergmun@telkomsa.net  
Community Services Manager: D Josephus  
Email: josephusd@bergmun.org.za  
Head: Disaster Management & Fire Service: D Alberts  
Tel no (022) 913 2372  
Cell no 083 272 3714  
Email: albertsd@bergmun.org.za  
Velddrif  
Tel no (022) 783-1112  
Fax no (022) 783-1422  
Porterville  
Tel no (022) 931-2100  
Fax no (022) 931-3047  
Aurora  
Tel no (022) 952-1720  
Fax no (022) 952-1720  
Eendekuil  
Tel no (022) 942-1780  
Fax no (022) 942-1687  
Redelinghuys  
Tel no (022) 962-1605  
Fax no (022) 962-1605  
Size of Bergrivier Municipal area: 4400 sq kms,  
Total mileage of vehicles per annum: 1500 kms  
Budget: R1200 000.00

## **BITOU LOCAL MUNICIPALITY PUBLIC SAFETY**

**(Plettenberg Bay)**  
**Fire & Emergency Services / Disaster Management**  
Cnr Marine Way & Flying Cloud Ave  
Private Bag X 1002  
Plettenberg Bay 6600

Tel no (044) 501 3230/1/2/3  
Fax no (044) 533-3443  
Emergency 044 533 5000  
Manager Public Safety: T Ndlovu  
Tell no (044) 501-3240  
Email (PA): sarsefilinganoholoza@plett.gov.za  
Chief Fire Officer: H Venter  
Cell no 083 443 0120  
Email: hventer@plett.gov.za  
Station Officer: Vacant  
Senior Fireman: A Swanepoel  
Cell no 073 227 9437  
Email: aswanepoel@plett.gov.za  
Senior Fireman: D Davids  
Cell no 072 502 8051  
Email: ddavids@plett.gov.za  
Senior Fireman: Vacant  
Size of area: 1 200 sq kms  
Population: 60 000 + triple during seasonal periods  
Emergency calls:554 - Fire Related Calls:352  
- Grass/veld fires:226 - Building fires:2 - Vehicle accidents:125 - Dwelling/shack fires:56 - Vehicle fires:7 - Utility Fires:7 - Industrial Fires:0 - Others:40 - False Alarms:14 - Hazmat Incidents:2 - Miscellaneous:9 - Water Deliveries:57 - Incidents with loss of Life:9  
Mileage of vehicles per annum: 109 000 kms  
Training sessions and Public Awareness:10  
Fire stations:2  
Main Fire Station (Plettenberg Bay)  
Kurland Fire Station (Plett East)  
Personnel:- Volunteer firefighters:2 - Chief Fire Officer:1 Officers:0 - Senior Fire fighters:2 - Fire fighters:9 - Learner Fire fighters:12 - EPWP Firefighters:10 - Control Room Operators:5

## **BREED VALLEY MUNICIPALITY FIRE AND RESCUE SERVICE**

### **(Worcester, Touwsriver, De Doorns, Rawsonville)**

*Fire Brigade Headquarters:* 1 Mercer Street, Worcester 6850  
Private Bag X3046  
Worcester 6849  
24 Hours Emergency: (023) 342 2430  
Free from landline: 107  
Free from cellphone: 112  
Senior Management:  
Tel no (023) 348 9062/4  
Website: www.bvm.gov.za  
Twitter: @bvfdceoc  
Facebook: Breede Valley Fire Department  
SARL Call Sign: ZS1 BVF  
Municipal Manager: D McThomas  
Tel no (023) 348 2602  
Fax no (023) 348 2667  
Email: mm@bvm.gov.za  
Chief Fire Officer: TC Botha  
Tel no (023) 348-9062  
Fax no (023) 347-1653  
Cell no 082 924 6514  
Email: tbotha@bvm.gov.za / fdbv@bvm.gov.za  
PA Office of the Chief: S Fox  
Tel no (023) 348 9062

Fax no (023) 347 1653  
Email: sfox@bvm.gov.za / : fireadmin@bvm.gov.za  
Operations Division Secretary: F Titus  
Tel no (023) 348 9064  
Fax no (023) 347 1653  
Email: ffitus@bvm.gov.za  
Duty Officer: 24 Hours (023) 348 9068  
Email: fireofficer@bvm.gov.za  
Fire Safety & Risk Management:  
Tel no (023) 348 9060/9071  
Email: firesafety@bvm.gov.za / firerisk@bvm.gov.za  
Training Section: Tel no (023) 348 9078  
Email: firetraining@bvm.gov.za  
*Support Services Section:*  
Tel no (023) 348 9067  
Email: firesupport@bvm.gov.za  
*Disaster Risk Management Section:*  
Tel no (023) 348 9065  
Email: firerisk@bvm.gov.za  
*Emergency Communication Section:*  
Tel no (023) 348 9060 /1  
Email: firecomm@bvm.gov.za  
Population: ±150 000  
Emergency calls: 726  
Personnel:- 62

## **CAPE WINELANDS DISTRICT MUNICIPALITY**

### **(Stellenbosch, Drakenstein, Witzenberg, Breede Valley and Langeberg Local Municipalities within its area of jurisdiction.)**

C/o Langenhoven and Bird Street, Stellenbosch, 7600  
PO Box 100  
Stellenbosch 7600  
Tel (021) 888-5100  
Fax (021) 886-6206  
Municipal Manager: M Mgajo  
Email mm@capewineland.gov.za  
Chief Fire Officer: DH Wilds  
Tel no (021) 888 5826, Fax no (021) 886 6206  
Email daniew@capewineland.gov.za  
Deputy Chief Fire Officer: W Josias (Training and Development & Operations Western Region)  
Cell no 082 300 4544  
Email: josias@capewineland.gov.za  
Tel no (021) 888 5310  
Cell 082 300 4544  
Fax no (021) 886 6206  
Head of Disaster Management Centre: SP Minnies  
Cell no 082 779 9823  
Email: shaun@capewineland.gov.za  
Size of area protecting: 22 309 sq kms  
Population: 685 786  
Emergency calls per annum: 1700  
Personnel:- Manager Support Services:1 - Regional Commanders:7 – Station Commanders:19 - Senior fighters, Fire fighters, Cadet fire fighters:36 - Control Centre operators:4 - Reservist Firefighters:60  
Fire Service Budget: R53 000 000

## **CITY OF CAPE TOWN FIRE & RESCUE SERVICE**

All Emergencies: 107 from a landline: (021) 480 7700 from a cellphone  
Fire & Rescue Service Command & Control Centre: Tel no (021) 590 1900  
Fax no (021) 590 4115  
Enquiries: Tel no (021) 590 1714  
*Head quarters: Goodwood*  
Goodwood Fire Station Hugo Street Goodwood 7460  
Private Bag X4  
Parow 7499  
Tel no (021) 590 1722  
Fax no (021) 590 1749 / 0733  
Chief Fire Officer: I Schnetler  
Tel no (021) 590-1738  
Cell 084 2200 214  
Fax no 086-201-2152  
Email: ian.schnetler@capetown.gov.za  
Secretary to Chief Fire Officer: G Espin  
Tel no (021) 590 1714  
Email: Gail.espin@capetown.gov.za  
Administrative Officer to Chief Fire Officer: L Paulsen  
Tel no (021) 590- 1702  
Fax no 086-201-2150  
Email: laetitia.paulsen@capetown.gov.za  
Head: Fire & Life Safety: I Smart  
Tel no (021) 590-1975  
Fax no 086-538-7981  
Cell no 084 209 0033  
Head: Training: C Manuel  
Tel no (021) 534-7608  
Cell 071 687 8721  
Email: clinton.manuel@capetown.gov.za  
*District West*  
Head: Operations District West: B Alers  
Tel (021) 444 8963  
Cell 084 225 1957  
Fax no (021) 461-9562 / 2456  
Specialist Clerk: L Brock  
Tel no (021) 444 8963  
Fire Stations (Enquiries)  
Roeland Street Tel no (021) 444 8963  
Sea Point Tel no (021) 434 0030  
Salt River Tel no (021) 444 0830  
Ottery Tel no (021) 444 3500  
Wynberg Tel no (021) 444 9621  
Constantia Tel no (021) 794 1128  
Hout Bay Tel no (021) 791 7960  
Lakeside Tel no (021) 788 9541  
Fish Hoek Tel no (021) 782 9082  
Simonstown Tel no (021) 786 3662  
*District North*  
Head Operations: C Cairncross  
Tel (021) 444 8270  
Cell 084 505 7826  
Fax no (021) 918 2067  
Clerk N Madela Tel no (021) 444 8271  
*Fire Stations (Enquiries)*  
Goodwood Tel no (021) 590 1722  
Epping Tel (021) 534 1387  
Durbanville Tel no (021) 444 7290  
Bellville Tel no (021) 444 8279  
Brooklyn Tel no (021) 510 5180  
Kraaifontein Tel no (021) 980 6177  
Milnerton Tel no (021) 550 1332  
Melkbos Tel no (021) 444 7308  
Atlantis Tel no (021) 444 4260  
Brackenfell Tel No: (021) 417 0151  
*District East*  
Head Operations - SF Martin

Tel no (021) 444 9101  
Cell 084 225 1963  
Fax no (021) 953-0312  
Clerk: A Ruiters Tel no (021) 444 9112  
*Fire Stations (Enquiries)*  
Belhar Tel no (021) 444 9111  
Lansdowne Tel no (021) 444 0438  
Mfuleni Tel no (021) 909 9660  
Strand Tel no (021) 444 7601  
Macassar Tel no (021) 444 6790  
Somerset West Tel no (021) 444 2700  
Mitchells Plain Tel no (021) 444 3085  
Khayelitsha Tel no (021) 444 8959  
Guguletu Tel no (021) 444 5481  
Head: Logistics & Planning: G Cilliers  
Tel no (021) 444 0392  
Cell no 084 225 1960  
Head Finance: T Ackerman  
Tel no (021) 590-1731  
Fax no 086 576 0691  
Cell no 084 220 0209  
Billing: Tel no (021) 590-1744  
*Workshops*  
SP Dano Tel (021) 444 8963  
Cell 084 610 7853  
Emergency Incidents 2016: Fire Related: 14523 - Special Service:12111  
Area of coverage: 2455 sq kms  
Population: 3.9 Million  
Personnel: 1190 (Uniformed and support)

## **DRAKENSTEIN LOCAL MUNICIPALITY FIRE AND RESCUE**

### **(Paarl)**

Berg River Boulevard Paarl  
PO Box 1  
Paarl 7620  
Switchboard Tel no (021) 807-4500 /4799  
Fire Tel no (021) 872-1404/6  
Emergency Tel no (021) 872-2323  
Fax no (021) 872 8054  
Municipal Manager: Dr J Leibbrandt  
Head of Communications: Ms M Haasbrook  
Email: records@drakenstein.gov.za  
Chief Fire Officer: DA Damons  
Cell no 082 807 4853  
Email: derick@drakenstein.gov.za  
Deputy Chief Fire Officer: D Pecour  
Chief Disaster Management: S Warren  
Size of area: 1537 sq kms  
Population: 186 188  
Value of area protecting: R35 000 000  
Emergency calls:- Grass/Veld fires:200 - Building fires:10 - Fatalities:12 - Vehicle fires:6 - Informal Dwelling fires :150 - Dwelling fires:12 - Other:20  
Value of property destroyed by fire: R11 300 000.00  
Mileage of vehicles per annum: 20 000 kms  
Personnel:- Senior firefighters:9 - Volunteer firefighters:50

## **GARDEN ROUTE DISTRICT MUNICIPALITY**

**(George LM, Knysna LM, Mossel Bay LM, Oudtshoorn LM, Bitou LM, Kannaland LM, Hessequa LM)**  
54 York Street, George  
PO Box 12  
George 6530  
Tel no (044) 803-1300  
Cell no 083 6302602  
Fax no 086-614-4228  
Email: info@gardenroute.gov.za

Executive Mayor: Cllr M Booysen  
Tel no (044) 803 1301  
Email: pa.mayor@gardenroute.gov.za  
Municipal Manager: M Stratu  
Tel no (044) 803-1300  
Email: pa.mm@gardenroute.gov.za  
Head of Communications: H Pieters  
Email: communications@gardenroute.gov.za  
Chief Fire Officer: F Thaver  
Cell no 061 443 7393  
Somerset West Tel no (021) 444 2700  
Deputy Chief Fire Officer: D van Wyk  
Cell no 084 782 2287  
Email: emergency@gardenroute.gov.za  
Chief Disaster Manager: G Otto  
Cell no 083 630 2602  
Size of area: 23 323 sq kms  
Population: ±613 124  
Emergency calls: ± 4500 per month  
Fire stations: 3  
Emergency Call Centre number: 044 805 5071 (24/7 availability)

## **GEORGE LOCAL MUNICIPALITY FIRE DEPARTMENT COMMUNITY SERVICES**

### **(George, Wilderness, Harolds Bay, Uniondale)**

Mitchell Str George  
PO Box 19  
George 6530  
Tel no (044) 801 6300  
Acting Chief Fire Officer: CJJ Barnard  
Tel no (044) 801 6377  
Cell no 083-233-6352  
Email: cijbarnard@george.gov.za  
Municipal Manager: T Botha  
Tel no (044) 801 9069  
Director: SB Erasmus  
Tel no (044) 801 6382  
Email: sberasmus@george.gov.za  
Law Enforcement Supervisor: R Von Willigh  
Tel no (044) 801-6350  
Size of area: 5190.43 sq kms  
Population:220 000  
Value of area: R946 million  
Emergency Calls:- Formal House Fires:79 - Informal House Fires:170 - Veld Fires:523 - Building Fires:23 - Motor Vehicle Fires:43 - Motor vehicle Accidents:443 – Other:342 - False Alarms:33 - Evacuation drills:10  
Mileage of vehicles per annum: 17 000 kms  
Personnel:- Officers:5 - Full-time Fire fighters:26 - Other staff:6 – Contract:5

## **HESSEQUA LOCAL MUNICIPALITY FIRE AND RESCUE SERVICES**

### **(Riversdal, Albertinia, Stilbaai, Heidelberg, CP Witsand, Jongensfontein, Melkhoufontein, Gouritzmond & Slangrivier)**

Van den Berg Str Riversdal  
PO Box 29  
Riversdal 6770  
Tel no (028) 713-7817 / 8000  
Fax no 086 4015 118  
Email: collab@hessequa.gov.za  
Municipal Manager: J Jacobs  
Tel no (028) 713-8001  
Email: mm@hessequa.gov.za  
Director Community Services: C Onrust  
Tel No (028) 713-8015  
Email: chris@hessequa.gov.za



**Department Protection Services**  
 Mulder Street, Riversdale Industrial  
 Manager Protection Services: A Voss  
 Tel no (028) 713 7817 / 7822  
 Emergency no 084 014 1828  
 Email: vossie@hessequa.gov.za  
 Size of area: 54000 sq kms  
 Value of area protecting: R80 000 000,00  
 Emergency calls:- Recoveries:15 -  
 Rescues:12 - Vehicle accidents:24 -  
 Grass/Veld Fires:41 - Building Fires:14 -  
 Dwelling Fires:12 - Fatalities:5  
 Mileage of vehicles per annum: 1173 kms  
 Personnel:- Officers:2 - Part-time firefighters:0  
 - Volunteer firefighters:0 - Contractual Fire  
 Fighters: 20 Awareness: Schools:26

**KNYSNA LOCAL MUNICIPALITY FIRE DEPARTMENT**

**(Knysna, Knoetzie, Rheenendal, Karatara, Sedgfield, Buffelsbaai, Jodenskal)**

35 Waterfront Rd Knysna  
 PO Box 21  
 Knysna 6570  
 Tel no (044) 302 8911  
 Fax no (044) 302-8922  
 Acting Municipal Manager: JB Douglas  
 Tel no (044) 302 6300  
 Email: mm@knysna.gov.za  
 Acting Chief Fire Officer: W Sternsdorf  
 Tel no (044) 302 8907  
 Email: wsternsdorf@knysna.gov.za  
 Station Officer: I Bezuidenhout  
 Tel no (044) 3028911  
 Email: ibezuidenhout@knysna.gov.za  
 Chief Disaster Manager: R Meyer  
 Email: rmeyer@knysna.gov.za  
 Cell no 082 922 8605  
 Chief Traffic Officer: A Bans  
 Tel no (044) 3026551  
 Cell no 060 998 7040  
 Email: abans@knysna.gov.za  
 Size of area: 105 934 sq kms  
 Population: 59440  
 Emergency calls:- Rescues/Recoveries:1 -  
 Grass/Veld fires:363 - Building fires:3 -  
 Vehicle accidents:118 - Dwelling fires:81 -  
 Special Service Calls:341 - Fatalities:3  
 Value of property destroyed by fire:  
 ± R4 500 000  
 Mileage of vehicles per annum: 35738kms  
 Fire stations: 3 + 2 rural fire crews (Knysna,  
 Sedgfield substation, Joodsekamp  
 substation)  
 Personnel:- Officers:2 - Full-time fire  
 fighters:30 - Volunteer fire fighters:20  
 Budget: R 17 000 0000

**LANGE BERG MUNICIPALITY**  
**(Ashton, Bonnievale, McGregor, Montagu, Robertson)**

28 Main Rd Ashton  
 Private Bag X2  
 Ashton 6715  
 Tel no (023) 615-8000  
 Fax no (023) 615-1563  
 Email: admin@langeberg.gov.za  
 Municipal Manager: S Mokweni  
 Director Corporate Services: AWJ Everson  
 Manager Disaster Management: Vacant  
 Population: 67 737  
 Size of area: 3335,3 sq kms  
 Emergency calls: Veld fires:72 - Dwelling  
 fires:38

Mileage of vehicles per annum: 3 237 kms  
 Personnel:- Full-time firefighters:2 -  
 Volunteer  
 firefighters:4  
 Budget: R64 000  
**Montagu sub-station**  
 Piet Retief Str Montagu  
 Private Bag X2  
 Ashton 6715  
 Tel no (023) 614-8000  
 Fax no (023) 614-1841  
 Acting Manager Disaster Management: A  
 Eyssen  
 Director Community Services: Ms C  
 Liebenberg

**MATZIKAMA LOCAL MUNICIPALITY**  
**(Vredendal, Van Rhynsdorp, Klawer, Doringbaai, Strandfontein, Ebenhaeser, Koekenaap)**

37 Kerk Str Vredendal  
 PO Box 98  
 Vredendal 8160  
 Tel no (027) 201-3300  
 Fax no (027) 213-3238  
 E-mail: jans@matzikamamun.co.za  
 Cell no 083 320-5949  
**Klawer Office** Tel no (027) 201 3423/4  
**Lutzville Office** Tel no (027) 201 3441/2  
**Van Rhynsdorp Office** Tel no (027)  
 201 3431/2  
**Ebenhaeser Office** Tel no (027) 201 3446/7  
**Doringbaai Office** Tel no (027) 201 3445  
**DMA Office** Tel no (027) 642 7017  
 Fax no (027) 642 7144  
 Acting Municipal Manager: J Pekeur  
 Cell no 083-231-1708  
 Office no (027) 201 3401  
 Fax no (027) 213 1504  
**Piketberg Fire Station**  
 Reiger Street, Piketberg  
 Station Commander: M Badenhorst  
 Tel no (022) 913 3316  
 Cell no 074 283 0999

Email: piketbergfire@gmail.com  
**Vredendal Fire Station**  
 Sirkeleet Street, Vredendal  
 Tel no (027) 213 1428  
 Acting Station Commander: SO Du Preez  
 Email: vrendendalfire@gmail.com  
 Acting Chief Disaster Management:  
 Mrs Visser  
 Email: jans@matzikamamun.co.za  
 Tel no (027) 201-3411  
 Fax no 086-645-1487  
 Cell no 083 320 5949  
 Size of area: ± 5500 sq kms  
 Population: ± 55 000  
 Emergency calls:- Grass/Veld fires:25 -  
 Building fires:55 - Vehicle accidents:6 -  
 Dwelling Fires:25  
 Value of property destroyed by fire:  
 R2 000 000.00  
 Mileage of vehicles per annum: 2 000 kms  
 Personnel:- Officers:12 - Fire fighters:6 -  
 Reservists:3  
 Budget: R40 000

**MOSSEL BAY LOCAL MUNICIPALITY FIRE & RESCUE SERVICES**

PO Box 25  
 Mossel Bay 6500  
 Tel no (044) 606-5031/2  
 Emergency no (044) 691-3722

SAPS: Tel no (044) 606 2800 / 2200/ 5600  
 Provincial Traffic Department: Assistant  
 Director: R Sarikakis  
 Tel no (044) 6934545  
 Fax no (044) 6934549  
 Email: Reinet.Srikakis@westerncape.gov.za  
 Municipal Manager: T Giliomee  
 Email: admin@mosselbay.gov.za  
 Director Community Services: E Nel  
 Tel no (044) 606 5000  
 Email: enel@mosselbay.gov.za  
 Chief Fire Officer: J Johnston  
 Tel no (044) 606 5035/6  
 Fax no (044) 691 1480  
 Cell no 082 424 4098  
 Email: jjohnston@mosselbay.gov.za  
 Chief Disaster Management: J Johnston  
 WC Provincial Ambulance: W Farao  
 Tel no (044) 691-1911  
 Size of area: 2 380 sq kms  
 Population: ± 140 000  
 Emergency calls: Grass/Veld fires:560 -  
 Building fires:6 - Vehicle accidents:243 -  
 Vehicle fires:11 - Fatalities:15 - False Alarms  
 Malicious:3 - False Alarms with Good Intent:  
 87- Special service calls:342 - Formal  
 Dwelling fires:38 - Informal Dwelling Fires:70  
 - Others:95  
 Value of property destroyed by fire:  
 R 6 060 888.70  
 Personnel:- Chief Fire Officers:1 - Station  
 Commander:2 - Officers:3 - Full-time fire  
 fighters:41 - Other staff:2 - Security  
 Officers:12  
 Budget: Capital R 1 570 070  
 Operating R 4 690 090  
**Main Fire Station: Mossel Bay Fire Station**  
 c/o Louis Fourie Road & Schoeman Street,  
 Mossel Bay,  
 Tel no (044) 606 5031  
**Fire House: Great Brak River sub-station**  
 Charles Str, Great Brak River 6525  
 Tel no (044) 620-2100

**OUTDSHOORN LOCAL MUNICIPALITY FIRE STATION**

**Fire Brigade Office:** Church Str Oudtshoorn  
 Municipality: Cnr Voortrekker & Langhoven  
 Sts, Oudtshoorn, 6625  
 PO Box 255  
 Oudtshoorn 6620  
 Tel no (044) 203-3000  
 Fax no (044) 203 3104  
 After hours Tel no (044) 203 3133  
 Municipal Manager: A Paulse  
 Tel no (044) 203 3004  
 Email: mm@oudtmun.gov.za /  
 suerhete@oudtmun.gov.za  
 Chief Fire Officer: JD Meintjies  
 Cell no 078 457 0751  
 Email: meintjies@oudtmun.gov.za  
 Chief Disaster Management: MW Konnie  
 Cell no: 082 907 8128  
 Traffic Chief: Provincial Traffic Oudtshoorn:  
 GAP Becker  
 Tel no (044) 272-4197  
 Fax no (044) 272-2297  
 Cell no 083 414 2001  
 Size of area: ± 3535 sq kms  
 Population: ± 100 000  
 Emergency calls: 250  
 Personnel:- Fire fighters:21

**OVERBERG DISTRICT MUNICIPALITY FIRE AND RESCUE**

**Greater Overberg Fire Protection Association**

**(Theewaterskloof, Swellendam, Cape Agulhas)**  
 22 Long Street Bredasdorp  
 Private Bag X22  
 Bredasdorp 7280  
 Head Fire & Disaster Management: R  
 Geldenhuys  
 Email: rgeldenhuys@odm.org.za  
 Tel (Office) (028) 425 1157 / 1690  
 Cell no: 083 273 8234  
 Fax no: 086 661 6067  
**Bredasdorp Sub District**  
 Platoon Commander: M Arends  
 Email: marends@odm.org.za  
 Tel no (028) 425 1157  
 Fax no 086 661 6067  
 Emergency calls tel no (028) 425 1690  
**Grabouw Sub District**  
 Divisional Commander: MR Abrahams  
 Email: mabrahams@odm.org.za  
 Tel no (021) 859 5525  
 Cell no 083 293 5327  
 Fax no 086 506 3737  
 Emergency calls tel no (028) 425 1690  
**Caledon Sub District**  
 Divisional Commander: G Haggard  
 Email: ghaggard@odm.org.za  
 Tel no (028) 212 3727 cell no 083 368 4189  
 Emergency calls tel no (028) 425 1690  
**Swellendam Sub District**  
 Divisional Commander: C Pieterse  
 Email: cpieterse@odm.org.za  
 Tel: 028 514 3980/90  
 Cell no 083 274 9322  
 Emergency calls tel no (028) 425 1690  
**Villiersdorp Sub District**  
 Divisional Commander: P Jambo  
 Email: pjambo@odm.org.za  
 Tel no (028) 840 0305  
 Cell no 073 440 0879  
 Emergency calls tel no (028) 425 1690

**OVERSTRAND LOCAL MUNICIPALITY**  
**(Gansbaai, Hermanus, Stanford, Kleinmond)**

Magnolia Ave Hermanus  
 PO Box 20  
 Hermanus 7200  
 Fire Brigade 24 hrs switchboard  
 Tel no (028) 313 8980  
 Tel no emergencies (028) 312 2400  
 Municipal Manager: C Groenewald  
 Email cgroenewald@overstrand.gov.za  
 Tel no (028) 313 8003  
 Director Protection Services: N Michaels  
 Tel no (028) 313-8054  
 Email: nmichaels@overstrand.gov.za  
 Chief Fire Services: L Smith  
 Tel no (028) 313 5041  
 Email: lestersmith@overstrand.gov.za  
 Size of area: ± 1708 sq kms  
 Population: 90 000  
 Emergency calls:- Grass/Veld fires:206 -  
 Residential:32 - Commercial structures:5 -  
 Informal housing:59 - Other fires:50 - Vehicle  
 accidents:121 - Special service:39 -  
 Rescues:13  
 Fire stations:3  
 Personnel: Chief Fire Officer:1 - Secretary:1

- Assistant Chief:3 - Divisional  
 Commander:1 - Senior Firefighters: 3 -  
 Assistant Disaster Management Officer :1 -  
 Administrator: Disaster Risk Management:1 -  
 Chief Clerk: Disaster Risk Management  
 Logistical Support:1 - Learner Firefighter: 31  
 - Reservists:11 - Community Firefighters:12

**SALDANHA BAY LOCAL MUNICIPALITY**  
**(Vredenburg, Saldanha, Paternoster, St Helena Bay, Hopefield, Langebaan, Jacobs Bay)**

12 Main Str Vredenburg, 7380  
 Private Bag X12  
 Vredenburg 7380  
 Switchboard: 022-701-7000  
 Fax no (022) 715-1518  
 Fire Call Centre 24 hrs: (022) 433 8700 /  
 713 1815 / 10177  
 Acting Municipal Manager: G Louw  
 Tel no (022) 701-7098  
 Email: mun@smb.gov.za  
 PA to MM: B Rossouw  
 Email: Benice.Rossouw@smb.gov.za  
 Traffic and Law Enforcement: M Jacobs  
 Tel no (022) 701 6900  
 Email: Mario.Jacobs@smb.gov.za  
 Size of area: 2015 km<sup>2</sup>  
 Population: 99 193 (2011 Census)  
 Emergency calls:- Rescues/Recoveries:175 -  
 Grass/Veld fires:228 - Building fires:7 -  
 Dwelling fires:46 - Informal settlements:48 -  
 Transport:16 - Medical:11 - Special  
 Services: 9 -  
 Value of property destroyed by fire: +/- R4  
 Million  
 Mileage of vehicles per annum: 90 000 kms  
 Fire stations: 1 (Vredenburg)  
 Personnel:- Officers:1 - Personnel:19  
 Operational Budget: R 3 800 000.00  
 Capital Budget: R600 000.00

**STELLENBOSCH LOCAL MUNICIPALITY FIRE AND RESCUE SERVICES**

Cluver Str Stellenbosch  
 PO Box 17  
 Stellenbosch 7599  
 Tel no (021) 808-8890  
 Email: Control.room@stellenbosch.gov.za  
 Chief Fire Officer / Manager: Fire and  
 Rescue Services & Disaster Management:  
 W Smith  
 Cell no 071 443 7337  
 Email: wayne.smith@stellenbosch.gov.za  
 Assistant Chief Fire Officers: BJ Brandsen,  
 (Fire Safety), A Steyn, C Murtz and C van  
 Reenen (Operations)  
 Senior Disaster Coordinator: S Seigels  
 Email:  
 shezayd.seigels@stellenbosch.gov.za  
 Municipal Manager: G Mettler  
 Municipal.manager@stellenbosch.gov.za  
 Tel no (021)808 8025  
 General (Municipal Switchboard)  
 Tel no (021) 808 8111  
 Tel no (021) 808 8878  
 Cell no 082 050 4834  
 Emergency calls: 957

**SWARTLAND LOCAL MUNICIPAL FIRE & EMERGENCY SERVICES**

**(Malmesbury, Moorreesburg, Riebeeek West, Riebeeek Kasteel, Darling, Yzerfontein, Koringberg)**  
**Main Station Malmesbury:**  
 Traffic Office Address: Piketberg Str  
 Malmesbury  
 Municipality Address: Church Street,  
 Malmerbury  
 Private Bag X52  
 Malmesbury, 7299  
 Emergency no (022) 487 9479  
 Tel no (022) 487-9400  
 Fax no (022) 487-9440  
 Cell no 082 771 4009  
 E-mail: swartlandmun@swartland.org.za  
 Director Protection Services:  
 PAC Humphreys  
 Chief Fire Officer/Disaster Management:  
 J Smith Email: smithj@swartland.org.za  
 Head Traffic and Law Enforcement Services:  
 R Steyn  
 Email: steynr@swartland.org.za  
 Size of area: 3700 sq kms  
 Population: 113 762  
 Emergency calls: Rescues/Recoveries:4 -  
 Grass/Veld fires:322 - Building fires:34 -  
 Fatalities:5 - Vehicle accidents:16- Others:23  
 Mileage of vehicles per annum: 4 000 kms  
 Personnel:- Officers:1 - Volunteer  
 firefighters:36  
 Fire stations: 7  
**Darling Sub Station**  
 Tel no (022) 492-2237  
 Tel no after hours (022) 487 9479  
**Koringberg Sub Station**  
 Tel no (022) 423 8024  
 Tel no after hours (022) 487 9479  
**Malmersburg Sub Station**  
 Tel no (022) 487 9400  
 Tel no after hours (022) 487 9479  
**Moorreesburg Sub station**  
 Tel no (022) 433-2246  
 Tel no after hours (022) 487 9479  
**Riebeeek Kasteel sub-station**  
 Tel no (022) 448-1258  
 Tel no after hours (022) 487 9479  
**Riebeeek West Substation**  
 Tel no (022) 461 2324  
 Tel no after hours (022) 487 9479  
**Yzerfontein Sub Station**  
 Tel no (022) 451-2366  
 Tel no after hours (022) 487 9479

**SWELLEN DAM LOCAL MUNICIPALITY**

49 Voortrek Str Swellendam  
 PO Box 20  
 Swellendam 6740  
 Tel no (028) 514-8500 / 8529  
 Fax no (028) 514-2694  
 Municipal Manager: A Groenewald  
 Email: info@swellenmun.co.za /  
 records@swellenmun.co.za  
 Traffic Officer: D Blauw  
 Email: blauwd@swellenmun.co.za  
 Director Corporate Services: D du Plessis  
 Email: duplessisd@swellenmun.co.za  
 Director Community Services: K Stuurman  
 Email: stuurmank@swellenmun.co.za  
 Tel no (028) 514-8500

**THEWATERSKLOOF TRAFFIC AND LAW ENFORCEMENT SERVICES**

Fire emergency services is rendered by the Overberg District Municipality  
6 Plein Str Caledon  
PO Box 24  
Caledon 7320  
Tel no Caledon (028) 214-3300  
Fax no (028) 214-1289  
Email: twkmun@twk.org.za  
Municipal Manager: Vacant  
Email: annettesw@twk.org.za  
Director Operations: J Barnard  
Email: janba@twk.org.za  
Chief Traffic and Law Enforcement Officer: S Jacobs  
Cell no 083 469 5948  
Email: saulja@twk.org.za  
Size of area: 3 231 sq kms  
Population: 108 790

**WEST COAST DISTRICT MUNICIPALITY (Matzikama, Cederberg, Bergrivier, Saldanha Bay, Swartland)**

58 Long Street Moorreesburg 7310  
PO Box 242  
Moorreesburg 7310  
Website: www.westcoastdm.co.za  
Email: westcoastdm@wcdm.co.za  
Tel no (022) 433-8400  
Fax no (022) 433-8484 / 086 692 6113  
Municipal Manager: D Joubert

Tel no (022) 433 8410  
Email: mm@wcdm.co.za  
Director: Administration and Community Services: W Markus  
Tel: 022 433 8410  
Email: wmarkus@wcdm.co.za  
Chief Fire Officer: B Senekal  
Tel no (022) 433 8702  
Cell no 083 236 4588  
Fax no (022) 433-8875  
Email: bsenekal@wcdm.co.za  
Size of area protecting: 31 099 sq kms  
Population 391 766  
Emergency Calls: - Industrial: 2 -  
Warehouses: 11 - Electrical: 11 -  
Rescues/recoveries:97- Grass/Veld fires:321  
- Mountain Fires: 54 - Hazmat:5 - Vehicle accidents:535 - Office/Shop Fires: 7 -  
Residential Fires: 54 - Informal Structures:83  
- Vehicle Fires:26

**WITZENBERG MUNICIPALITY PROTECTION SERVICES (Ceres, Prince Alfred, Hamlet, Op Die Berg, Tulbagh, Wolseley)**

Pine Forest Resort, Carson Str Ceres  
PO Box 44  
Ceres 6835  
Tel no (023) 316-8196  
Fax no (023) 316-1877  
Emergency number (023) 316-1997/8  
Email: admin@witzenberg.gov.za

Municipal Manager: D Nasson  
Tel no (023) 316-1854  
Fax no (023) 316-1877  
Cell 084 448 2802  
Email david@witzenberg.gov.za  
Director Community Services: Ms J Krieger  
Email: jo-ann@witzenberg.gov.za  
Manager: Fire & Disaster Management Services: H Visser  
Email hermie@witzenberg.gov.za  
Tel no (023) 316 1854  
Size of area: 2851 sq kms  
Population: ± 83 566  
Emergency calls: Rescues / Recoveries:62 -  
Special service calls:16674 - Grass/Veld fires:247 - Building fires:2 - Informal Housing:57 - Fatalities:5 - Vehicle accidents:80 - Dwelling fires:8  
Value of property destroyed by fire: R 260 000  
Mileage of vehicles per annum: 20520 kms  
Fire stations: 4 satellite fire stations (Wosley, Tulbagh, Prince Alfred's Hamlet, Op Die Berg)  
Personnel:- Fire fighters:2 - Volunteers: 24  
Budget: R879 551.00  
*Wolseley sub-station*  
Voortrekker Str Wolseley  
PO Box 44  
Ceres 6835  
Tel no (023) 316 1854  
Fax no 023 316 1877

Fax no (054) 3326502  
Private Bag X5936 Upington 8800  
Manager Airfield Services: C Willemse  
Email: conwill.willemse@airports.co.za  
Cell no 082 829 0862  
Assistant Manager Fire and Rescue Services: M Valla  
Cell no 079 512 3396  
Fax no 054 332 6502  
Email: Marius.Valla@airports.co.za  
**Airports Training Academy**  
New Operations Building, Gate 14 Bonaero Drive, Bonaero Park, 1620  
PO Box 75480,  
Gardenview, 2008  
Manager Technical Training: B Naidoo  
Tel no 011-921-1617  
Fax no 011-921-6661  
Cell no 082-960-3709  
Chief Training Officer: T Mangweni  
Tel no 011 921-6419  
Cell no 082 312 1081  
Fax no 011-921-6661  
Email: Thomas.Mangweni@airports.co.za  
ARFF Manager: S Msibi  
Tel no 032-4366568  
Cell no 082-959-4678  
Email: Stanley.Msibi@airports.co.za  
Training Coordinator: Eddie Van Rooyen  
Tel no 011-921-6418  
Fax no 086 661 2110  
Email: Eddie.vanRooyen@airports.co.za

**ALGOABAY FIRE SERVICES CC**

(Outsourcing of Fire Services)  
PO Box 6090  
Port Elizabeth 6000  
55 Gavin Drive, Scheepers Hoogte, Uitenhage  
Head office Tel no: (041) 9226539  
Executive Director - Wimpie Kruger  
Cell 071 790 6979  
Email: wsk@zawebs.com  
Operations Manager - Vaughan Marshall  
Cell 083 554 4613  
Email: vaughan@algoabayfire.co.za  
www.algoabayfire.co.za

**ANKER COAL & MINERAL HOLDINGS**

(Mining)  
PO Box 33 Clewer, 1036  
Tel no (013) 659 9900  
Safety, Health & Environmental Manager: B Moeketsi  
Email: bridgee.ntha@gmail.com

**ANGLO AMERICAN CORPORATION OF SA LTD**

(Mining)  
PO Box 8208, Rustenburg, 0300  
Tel no (014) 598 1085  
Safety Officer: L Erasmus  
Cell no 071 857 6174  
Email: Lawrence.Erasmus@angloamerican.com

**ANGLO AMERICAN THERMAL COAL**

(Mining Coal)  
PO Box 61587  
Marshalltown 2017  
Tel no (011) 638 2732  
Fax no (011) 638 2645  
Head of Safety and Sustainable Development: Leslie Martin

Email: leslie.martin@angloamerican.com  
Risk Manager: PJ Goosen  
Tel no 0136915220  
Cell no 083 414 7011  
Email: johan.goosen@angloamerican.com

**ANGLO AMERICAN COAL MOZAMBIQUE INTERNATIONAL**

(Mining)  
Comandante Moura Braz Rua No 27 R/c Maputo  
Tel no 00258 21 403142  
Fax no 00258 21 403144  
SHE Manager: ME Engels  
Tel no 00258 82 3077662  
Email: mengels@anglocoal.co.za

**ANGLO AMERICAN KUMBA IRON ORE MINE**

(Sishen Iron Ore Mine)  
Hendrik van Eck St, Kathu  
Private Bag X506 Kathu 8446  
Tel no (053) 739-2911  
Fax no (053) 739-2000  
Head Fire Prevention: E Mokoa  
Email: ezeziel.mokoa@angloamerican.com  
Tel no (053) 739-2111  
Cell no 083 304 0252  
Emergency Response Officer: J Zietsman  
Tel no (053) 739-2111  
Cell: 082-318-4435  
Personnel: 24 fire fighters, 4 Senior Fire Fighters

**ANGLO AMERICAN OPERATIONS LIMITED**

(Mining)  
21 Main St, Postmasburg, 8420  
SHE Manager: JM Esterhuizen  
Tel no (053) 313 9016  
Cell no 076 419 9339  
Email: Johan.Esterhuizen@angloamerican.com

**ANGLO AMERICAN - FUNCTIONAL CENTRE POLOKWANE**

(Mining)  
Private Bag X2463 Mokopane 0600  
Tel no (015) 418 2248  
Fax no 086 760 0834  
SHE Designator: P de Bruin  
Tel no: 015 293 4559  
Email: patsy.debruin@angloamerican.com

**ANGLO AMERICAN THERMAL COAL - NEW VAAL COLLIERY**

(Mining)  
New Denmark Colliery  
Private Bag x 2022, Standerton, 2430  
Tel no 017 749 0902 / 017 749 0109  
Safety Manager: R Mokaila  
Email: Rachel.mokaila@angloamerican.com  
Personnel: 35 volunteer firemen  
1 doctor, 3 nurses

**ANGLOGOLD ASHANTI LIMITED**

(Mining)  
PostNet Suite 1051 Private Bag X1007 Lyttelton 0140  
Tel no 011 637 6736  
Cell no: 0824181392  
Fax: 086 619 2018  
Vice President Safety: GH Coetzee  
Email: GHCoetzee@AngloGoldAshanti.com  
**Moab Khotsong Mine**

PO Box 8044 Western Levels 2501  
SHEQ Manager: Vacant  
Tel no (018) 478-1983  
**Tau Lekoa Mine**  
Private Bag X800, Stilfontein  
Tel no (018) 473-7063  
Admin: Anita Savvas  
Email: anitas@taulekoa.co.za  
SHE Officer: Francois Matthee  
Tel no (018) 473-7057  
Email: francoism@taulekoa.co.za  
**Tau Tona Mine**  
Tafelberg Ext 9 Tau Tona Mine  
PO Box 8104 Carltonville 2501  
SHEQ Officer: ZO Steven  
Tel no (018) 700 6275  
Email: zosteven@anglogoldashanti.com  
**Vaal Reef Mine**  
Private Bag X5010 Vaal Reefs 2621  
HSE Officer: Vacant  
Tel no (018) 478-6108

**ASSMANG LIMITED BLACK ROCK**

(Mining)  
PO Box 104 Santoy 8491  
Occupational Hygienist Officer: Wayne G Scott  
Tel no (053) 7515227/4071  
Cell no 0825759899  
Email: waynes@brmo.co.za

**ASSMANG IRON ORE**

(Mining)  
Private Bag X503 Kathu 8446  
Tel no (053) 723 8021  
Fax no (053) 311 4310/ 086-650 6317  
Superintendent Management Systems: JD Louw  
Cell no 072 225 7790  
Email: John.Louw@assmang.co.za

**BARPLATS MINE LTD**

(Platinum mining)  
Old Zandfontein Road Brits, 0250,  
PO Box 513 Brits 0250  
Tel no (012) 381-1800  
Fax no (012) 381-1893  
Fire Safety Officer: George Mohapi  
Tel no (012) 381-1800  
Email: gmohapi@eastplats.co.za  
Mine Rescue Services: Robert Jardine  
Tel no (012) 3811800  
Email: rjardine@eastplats.co.za  
Manager Operations: LJ Berrange  
Tel no (012) 3811840  
Cell no 082 3017260  
Email: lberrange@eastplats.co.za

**BHP BILLITON (PTY) LTD (SOUTH 32) - HOTAZEL MANGANESE MINES**

(Mining)  
PO Box 1  
Hotazel 8490  
HSE Co-ordinator: SA Le Roux  
Tel no (053) 742-2481  
Cell no 0828551230  
Email: Stephanus.leroux@south32.net

**BHP BILLITON (SOUTH 32) ENERGY COAL SOUTH AFRICA**

(Mining)  
PO Box 12162 Leraatsfontein Emalahleni 1038  
HSEQ Manager: Derick Rex

# INDUSTRIAL FIRE SERVICES

**AFRICAN RAINBOW MINERALS /ARM COAL**

(Mining)  
ARM House, 29 Impala Rd, Chislehurst, Sandton  
PO Box 786136 Sandton 2146  
Admin Tel no: (011) 011 779 1300  
Email: Alyson.doyley@arm.co.za  
Procurement Manager: M Naidoo  
Tel no: (011) 011 779 1000  
Email: magen.naidoo@arm.co.za  
SHEQ Manager: Joe Schoeman  
Tel no: (011) 011 779 1000  
Email: Joe.Schoeman@arm.co.za

**AIRPORTS COMPANY SOUTH AFRICA SOC LIMITED**

PO Box 75480 Gardenview 2047  
Tel no (011) 921 6242  
Fax (011) 453-9354  
Occupational Health & Safety Co-ordinator: A Shachar Tel: 011 921 6587  
Cell no 082 374 5576  
Email: Adi.Shachar@airports.co.za  
**Bram Fischer International Airport Fire Department**  
Airport Tel: (051) 407 2200  
Tel no: Manager Airfield - (051) 407-2221  
Assistant Manager: Fire & Rescue - (051) 407-2217  
Fax no 0866072779  
Private Bag X20562 Bloemfontein 9300  
Manager Airfield: C Oberholzer  
Tel: 051 407 2221  
Cell no 082 749 3914  
Email: colin.oberholzer@airports.co.za  
Assistant Manager: Fire & Rescue: M Seroto

Cell no 0796431030  
Email: Moses.Seroto@airports.co.za  
**Cape Town International Airport Fire Department**  
Private Bag x1, Suite 57, Brackenfell, 7561  
Tel no (021) 937-1200 /1211  
Fax no 086 607 6347  
Manager Airfield Services: M Nefdt  
Tel no (021) 937-1249  
Email: Mervyn.Nefdt@airports.co.za  
Training Officer: Tel no (021) 937 1365  
**East London Airport**  
Tel no (043) 706-0359  
Fax no 043-706-0313  
Private Bag X109 East London 5200  
Manager Airfield Services: Vacant  
**George Airport Fire Department**  
Tel no (044) 876-9310  
Fax 044 876 9027  
PO Box 10000 George 6530  
Chief Fire and Rescue: E Booi  
Tel no (044) 876 9310  
Cell no 081 347 3678  
Email: eric.booi@airports.co.za  
**Kimberley Airport Fire Department**  
Tel no (053)830-7107  
Fax no (053) 851-7110  
Private Bag X5052 Kimberley 8300  
Fire & Rescue: Jaco Ferreira  
Email: Jaco.Ferreira@airports.co.za  
**King Shaka International Airport Fire Department**  
PO Box 57701, King Shaka International Airport, 4407  
Tel no (032) 436-6000 /6568  
Fire Station Tel no (032) 436 7175 / 6722  
Chief Fire Officer: S Mckenzie

Email: clint.mckenzie@airports.co.za  
Training Officer: Musa Dube  
Email: Musa.Dube@airports.co.za  
Fire & Rescue Training Officer: Sean Govender  
Email: sean.govender@airports.co.za  
Tel no 032 436 4968  
Cell no 082 457 8591  
**OR Tambo International Airport Fire Department**  
Private Bag X1 OR Tambo International Airport 1627  
Tel no (011) 921 6596 / (011) 921-6598  
Fax no 086 607 1724  
Fire Chief Officer: C Naidoo  
Cell no 082 462 3013  
Email: clive.naidoo@airports.co.za  
**Pilansberg International Airport Fire Department**  
Peter Wagner Ave Mogwase  
Private Bag X1016 Mogwase 0314  
Tel no (014) 552-1261  
Assistant Fire Chief: Morgan Matshele  
Cell: 073-324-7965  
Email: mmatshele@nwpg.gov.za  
**Port Elizabeth Airport Fire Department**  
PO Box 5787 Walmer 6065  
Tel no (041) 507-7314/5  
Chief Fire Officer: Vacant  
Tel no (041) 507-7323  
Cell no 079 898 5160  
Fax no (041) 507- 7358  
Email: Mava.Mazwi@airports.co.za  
**Upington International Airport Fire Department**  
Tel no (054) 337 7900 Switchboard  
Fire Dept Tel no (054) 337 7908

Tel no (013) 689 4047  
Email: derick.rex@south32.net

**BOMBELA OPERATING COMPANY**

(Railway Operator)  
PO Box 1309 Kelvin 2054  
Tel (011) 253 0026  
Fax no (011) 253 0099  
Safety Specialist: Hubert Luvalo  
Hubert.luvalo@bombelaop.co.za

**BP SOUTH AFRICA**

(Refining fuels and lubricants)

**BP Waterfront**

Merchant House, Dock Rd, Portwood Ridge  
V&A Waterfront Cape Town 8000  
P O Box 50736 V&A Waterfront  
Cape Town 8002  
Tel no (021) 408-2911  
Head of Safety: Willemina Potgieter

**BMW OF SOUTH AFRICA**

Service supplied by Algoabay Fire Services cc

6 Frans du Toit Street, Rosslyn, Pretoria  
Tel no (012) 522 3000  
Fax no (012) 522 2347  
Tel no Algoabay Fire Services cc  
Wimpie Kruger: Tel no (041) 373 0335  
Cell: 071 790 6979  
Email: wsk@zawebs.com

**CHEVRON SOUTH AFRICA (PTY) LIMITED**

(Petrochemical Refinery)

Platteklouf Rd Milnerton  
PO Box 13 Milnerton 7435  
Tel no (021) 508-3911  
Chief Fire Officer: Michael Clarke  
Tel no (021) 508 3445  
Cell no 083 709 2374  
E Mail: clarkemichael@chevron.com  
Safety Specialist: KP Tshangana  
Tel no (021) 508 3296  
Email: KTXD@chevron.com  
Tel no (021) 508 3445  
Cell no 083 701 7646  
Fire Specialist: Xolani Maseti  
Tel no (021) 508 3308  
Email: xmas@chevron.com  
Fire Protection Officer: D Jacobs  
Tel no (021) 508 3428  
Email: DJBV@chevron.com  
Fire Instructor: S Mbebe  
Tel no (021) 508 3911

**DE BEERS CONSOLIDATED MINES**

(Mining)

**Venetia Diamond Mine**

1 National Road, Musina  
PO Box 668 Musina 0900  
Tel no (015) 575 2054  
Mine Safety Manager: Lawrence Maswanganyi  
Tel no (015) 575 2712  
Email: Lawrence.Maswanganyi@debeers-group.com  
Chief Fire Officer: D van der Walt  
Tel no (015) 575-2054  
Cell no 083 501 8306  
Fax: 015-575-2043  
Email: dries.vanderwalt@debeersgroup.com  
Chief Safety Officer: Eric Khoza  
Tel no (015) 575-2104  
Email: Eric.Khoza@debeersgroup.com

Chief Safety Officer: Pheonah Salani  
Tel no (015) 575-2405  
Email: Pheonah.Salani@debeersgroup.com  
Occupational Hygienist: T Mofokeng  
Tel no (015) 575-2373  
Email:  
Tebello.Mofokeng@debeersgroup.com  
Cell no 072 765 7167

**Finsch Mine**

PO Box 7 Lime Acres 8410  
Fire Safety Manager & ER24: AC Douglas  
Tel no (053) 385-2513  
Cell no 082 890 0152  
Email: Andy.Douglas@petradiamonds.com

**DENEL INDUSTRIAL PROPERTIES**

*Kempton Park Campus*

PO Box 15504 Impala Park 1472  
Kempton Park Campus  
Chief Fire Officer: Anna Malope  
Tel no (011) 927-2345  
Fax no (011) 927-2345  
Cell no 078 226 2845  
Email: annam@denprop.co.za  
Station Officer: A Malope  
Tel no (011) 927-2338  
Fax no (011) 927-2902  
Cell no 0782262845  
Email: annam@denprop.co.za

**DUNLOP INDUSTRIAL PRODUCTS**

*(Industrial Products Division)*

(Manufacturer conveyor belts, automotive components, rubber)  
Induna Mills Rd Howick  
PO Box 29 Howick 3290  
Tel no (033) 239-7200  
Fax no (033) 239 7291  
Manager SHE: Vinothan Perrimal  
E-mail: vonothanp@dunlopindustrial.co.za

**ENGEN PETROLEUM LIMITED**

(Sale of petroleum products)

**Durban**

171 Blairatholl Rd Westville  
PO Box 136  
Durban 4060  
Tel no Head Office: (021) 403-4911 / (031) 250-2911  
Fax no (031) 250-2929  
Engineering Service Manager: Barry Sitharam  
Email: Barry.Sitharam@engenoil.com  
Training Officer: Vacant  
Tel no (031) 250 2911  
Personnel: 5 person proto-team fire fighter  
**Cape Town**  
PO Box 35 Cape Town 8000  
Tel no (021) 403 4911 /4155  
Fax no (021) 403 4067  
HSE Manager: Sandra Redelinghuys  
Tel no (031) 250 2777  
Email: Sandra.redelinghuys@engenoil.com

**ENGEN REFINERY**

*A division of Engen Petroleum Limited*

(Oil refining)

465 Tara Rd Wentworth Durban  
PO Box 956 Durban 4000  
Tel no (031) 460-3302  
Fax no (031) 460-3213  
Cell no 074 354 7505  
Chief Fire Officer: Lenny Naidoo  
Email: Lenny.Naidoo@engenoil.com

Emergency Response Co-ordinator:

John Isaacs  
Tel no 031 460 2409  
Email: John.Isaacs@engenoil.com  
Personnel: 5 Fire Officers, 10 Fire Fighters  
Fulltime, 1 emergency Response co-ordinator, 50 auxiliary fire crew, 1 doctor (Part time), 3 nurses

**ESKOM**

**Eskom Megawatt Park Fire Risk and Emergency Management**

PO Box 1091 Johannesburg 2000  
Senior Advisor Fire Risk & Emergency Management: Marius Atterbury  
Tel no (011) 897 6285  
Email: AtterBM@eskom.co.za  
Senior Advisor Fire Risk & Emergency Management: Peter May  
Tel no (011) 800-5390  
Fax no 086 536 5373  
Email: Peter.May@eskom.co.za  
**Kendal Power station**  
Private Bag X7272 Witbank 1035  
Cell no 083 998 6093  
Fire Officer: Lawrence Magadla  
**Kriel Power Station**  
Private Bag X5009 Kriel 2271  
Tel no (017) 615 -2399  
Fire Officer: P Mulder

**Koeberg Nuclear Power Station**

Private Bag X10 Kernkrag 7440  
Tel no (021) 550-4610  
Fire Officer: R Barnes  
**Komati Power Station**  
Private Bag Blinkpan 2250  
Tel no (013) 295-9497  
Fire Officer: M Mononyane  
**Lethabo Power Station**  
Private Bag x415 Viljoensdrift 1930  
Tel no (016) 457-5518  
Assist Officer Fire Risk Management: Siphon Themba Msimanga  
**Majuba Power Station**  
Private Bag 9001 Volksrust 2470  
Tel no (017) 799-3192  
Fire Officer: W Volker

**FOODCORP RCL FOOD CONSUMER (PTY) LTD**

(Grocery)  
(A division of Foodcorp (Pty) Ltd)  
2 Desert Str Homelake  
PO Box 72 Randfontein 1760  
Tel no (011) 411-5400  
Fax no (011) 692-1665  
Cell no 083 441 2402  
HR Business Partner: Ayanda Dlamini  
Tel no (011) 411 5512  
Email: ayanda.dlamini@rclfoods.com  
Training Officer: Ayanda Dlamini  
Tel no (011) 411-5526

**FOREST FIRE ASSOCIATION - KISHUGU**

(Government funded job creation programme)  
**Head Office:**  
1 Club Street Working on Fire / Kishugu  
Building Nelspruit Airfield Mpumalanga  
Tel (013) 741 6400  
Manager: Willemien Hodgkinson  
Email: Willemien.Hodgkinson@kishugu.com  
**National Office:**  
Winter House, Kirsten Bosch Gardens

Tel no (017) 779 8594  
Senior Advisor – Fire Risk Management:  
Roggers Mamaila  
E-mail: MamailR@eskom.co.za  
**Hendrina Power Station**  
Private Bag X1003 Pullen's Hope 1096  
Cell 076 128 4085  
Fire Officer: Nkosinathi Sibiyi  
**Peaking (Head Office)**  
PO Box 3487 Tyger Park 7536  
Tel no (021) 949-1360  
Safety: L Jacobs  
Tel no (021) 941-5800

**Site and contract people:**

**Drakensberg**  
Bernard Schirge Tel no (036) 438-2030  
**Palmiet**  
Shawn Hurling Tel no (021) 859-2580  
**Vanderkloof**  
Edwin Silika Tel no (051) 754 0400  
**Gariep**  
Elias Mokwena Tel no (053) 6640002  
**Acacia (Cape Town)**  
Ishmael Mogotlane Tel no (021) 558 7266  
**Port Rex (East London)**  
Eric Adams - Tel no (043) 731 2045  
**Gourikwa (Mossel Bay)**  
James Classen Tel no (044) 606-3410  
**Ankerlig (Atlantis)**  
Rodney Booth Tel no (021) 573 6002

**FINE CHEMICALS CORP (PTY) LTD**

(Manufacturer Active Pharmaceutical Ingredients)  
15 Hawkins Ave Epping No 1  
PO Box 253 Eppindust 7460  
Tel no (021) 530 8100  
Fax no (021) 531 1458  
Emergency Telephone no (021) 530 8130  
OHSE Risk Officer: Shafiek Faure  
Email: sabels@aspennpharma.com  
HOD HR Manager: Shonel Abels  
Tel: 021 530 8165  
Email: sabels@aspennpharma.com  
Personnel: 10 man factory fire team

**FOODCORP RCL FOOD CONSUMER (PTY) LTD**

(Grocery)  
(A division of Foodcorp (Pty) Ltd)  
2 Desert Str Homelake  
PO Box 72 Randfontein 1760  
Tel no (011) 411-5400  
Fax no (011) 692-1665  
Cell no 083 441 2402  
HR Business Partner: Ayanda Dlamini  
Tel no (011) 411 5512  
Email: ayanda.dlamini@rclfoods.com  
Training Officer: Ayanda Dlamini  
Tel no (011) 411-5526

**FOREST FIRE ASSOCIATION - KISHUGU**

(Government funded job creation programme)  
**Head Office:**  
1 Club Street Working on Fire / Kishugu  
Building Nelspruit Airfield Mpumalanga  
Tel (013) 741 6400  
Manager: Willemien Hodgkinson  
Email: Willemien.Hodgkinson@kishugu.com  
**National Office:**  
Winter House, Kirsten Bosch Gardens

Rhodes Avenue, Newlands,  
Cape Town 7700  
Tel no (021) 797-5787  
Contact Person: Liane Truter  
Email: comms@kishugu.com

**FOSKOR LTD**

(Mining)  
27 Selati Rd, Phalaborwa  
PO Box 1 Phalaborwa 1390  
Tel no (015) 789-2000  
Fax no (015) 789-2066  
Superintendent Emergency Services:  
Bulelwa Mpfu  
Email: bulelwam@foskor.co.za  
Training Officer: D Ledwaba  
Tel no (015) 789 2345  
Email: dorothea@foskor.co.za  
Personnel: 24 Fire Fighters, 1 doctor, 10 paramedics, 4 nurses, 6 first aid instructors  
95% of Foskor staff are in possession of valid Red Cross Mining first aid certificates

**GLENCORE**

(Manufacturer ferrochrome)  
On the Ohrigstad Rd North of Lydenburg  
PO Box 195  
Lydenburg 1120  
Tel no (013) 230-6000  
Fax no (013) 230-6002  
Sustainable Development Manager:  
B Beeming  
Tel no (013) 230 6016  
Email: gcp@glencore.com  
Security Co-Ordinator: J Engelbrecht  
Tel no (012) 318-0758  
Cell no: 079-523-2586  
Email: Jacques.Engelbrecht@glencore.co.za  
Personnel: 24 firemen

**GOLD FIELDS LTD - SOUTH DEEP GOLD**

**MINE**

(Gold Mining)  
PO Box 776 Westonaria 1780  
Safety Officer: Braam van der Berg  
Tel no (011) 411 1768  
Email: braam.vanderberg@goldfields.com  
Emergency Response Team Co-ordinator:  
F Joubert  
Tel no (011) 411-1196  
Email: Francois.Joubert@goldfields.com

**GOODYEAR SOUTH AFRICA (PTY) LTD**

Service supplied by Algoabay Fire Services cc  
Algoa Road Uitenhage  
PO Box 126 Uitenhage 6230  
Tel no (041) 994 6290  
Fax no (041) 992-6306  
Chief Fire Officer: Mlungiseleli Ciko  
Tel (041) 994 6338  
Email: mlungiseleli\_ciko@goodyear.com

**HARMONY GOLD MINING CO LTD**

(Gold mine)  
Cnr Ward & Main Reef Rd Randfontein  
PO Box 2  
Randfontein 1760  
Tel no (011) 411-2000  
Fax no (011) 692 3879  
Fire Officer: Louis Botha  
Tel no (011) 411 2143  
Email: louis.botha@harmony.co.za  
Training Officer: Antony Michaels

Tel no (011) 411 2060  
Email: antony.michaels@harmony.co.za  
Personnel: 10 firemen

**IDWALA INDUSTRIAL HOLDINGS**

(Producer of lime and industrial minerals)

**Head Office**

First Floor Block F Wild Fig Office Park  
Cranberry Road Honeydew 2040  
Private Bag x 10  
Honeydew, 2040  
Tel no (011) 795-4900  
Fax no (011)795-4923  
Chief Operating Officer: R Ramthol  
Tel no (011) 795 8000  
Cell no 083 556 9981  
Email: ram@idwala.co.za  
Group SHEQ Manager: Justin Dell  
Tel no 011 795 4900  
Cell no 082 927 0966  
Email: JDell@idwala.co.za  
Managing Director: Wayne Brown  
Email: bro@idwala.co.za  
Cell no 083 264 7226

**Idwala Lime**

**Danielskuil:** Ouplaas Factory Industrial Area  
Danielskuil 8405  
PO Box 89  
Danielskuil 8405  
Tel no (053) 384 8599  
Fax no (053) 384 0671  
Risk Manager: LJ du Plessis  
Cell no 083 234 0468  
Email: dps@idwala.co.za  
General Manager: Jaco Swanepoel  
Cell no 083 252 0343  
Email: swa@idwala.co.za

**Idwala Lime**

Vereeniging: Cnr Kelvin and Rosherville  
Street Powerville Vereeniging 1930  
Tel no (011) 795 4900  
General Manager: Godfrey Mangotlo  
Tel no (016) 455 1180  
Cell no 071 869 8239  
Email: man@idwala.co.za

**Idwala Carbonates**

Port Shepstone  
Tel no (039) 687-8000  
Fax: 039 687 8027  
General Manager: Andy Ogle  
Tel no (039) 687 8000  
Email: ogl@idwala.co.za

**Idwala Industrial Minerals**

36 Commissioner street,  
Benoni Industrial Sites 1501  
P O Box 6056  
Dunswart  
Tel: 011-914-2600,  
Fax: 011 914 1293  
General Manager: Atang Maboe  
Tel no (011) 914 2600  
Cell no 083 842 5976  
Email: mab@idwala.co.za  
**Idwala Magnetite**  
C/o Foskor Mine Phalaborwa 1390  
P O Box 1914  
Phalaborwa, 1390  
Tel no (015) 781-3736 / 5591  
Fax: 015 781 7789  
Manager: Peter Adonis  
Tel: 011 795 4900  
Cell no 083 632 5641  
Email: ado@idwala.co.za

**IMPALA PLATINUM LTD**

PO Box 1050  
Rustenburg 0300  
Tel no (014) 569-7340  
Fax no (014) 569-7056  
Senior Safety Officer: Carina Burger  
Email: Carina.Burger@implats.co.

**IMPALA PLATINUM REFINERY (PTY) LTD**

PO Box 222  
Springs 1560  
Tel no (011) 360 3156  
Fax no (011) 360 3062  
Senior Safety Officer: Steven Engelbrecht  
Email: Steven.engelbrecht@implats.co.za

**KOORNFontein MINES (PTY) LTD**

(Mining)  
Private Bag X402  
Blinkpan Mpumalanga 2250  
Tel no (013) 295-5364  
Health and Safety Manager: Hennie Coetzee  
Email: hennie.coetzee@optimumcoal.com

**MAFUBE COAL MINING (PTY) LTD**

(Mining)  
Mafube Colliery, Farm Springboklagte  
Private Bag X3385 Middelburg 1050  
Safety Supt: SJ Harper  
Tel no (013) 246 9407

**MALANDELA SECURITY SERVICES (PTY)**

**LTD FIRE SERVICES** Coastal Division  
Kwazulu Natal

**G4 Security Services (Pty) Ltd**

Coastal Division Kwazulu Natal  
G4 Security Services (Pty) Ltd  
(Hotel & casino holiday resort)  
Old Main Rd Bizana  
PO Box 23  
Port Edward 4295  
Tel no (039) 305-2931  
Fax no 086 592 4673  
Fire/Security Manager: Owen Irvin Barnabas  
Email: owenirvin.barnabas1@suninternational.com  
Tel no 039 305 2931  
Fax no 086 592 4673  
Personnel: Chief:1- Officers:3 - Fire fighters:9

**MARULA PLATINUM (PTY) LTD**

(Mining)  
Winnarshoek Stand No 118, Driekop 1120  
PO Box 1496 Steelpoort 1133  
Tel no (013) 214 6000  
Fax no (086) 609 7576  
Engineering Safety Officer: T Pretorius  
Tel: 013 214 6006  
Cell no 082 428 5170  
Email: talite.pretorius@implats.co.za

**MERCEDES BENZ SOUTH AFRICA (PTY) LTD**

(Motor assembly)  
Settlers Way East London  
PO Box 671 East London 5200  
Chief Fire Officer  
Tel no (043) 706-2018  
Cell 083 454 7706  
Station Officers Tel no (043) 706-2497  
Control Room Tel no (043) 706-9716  
Fax no (043) 706-9951

Chief Fire Officer: Wayne Blair Brown  
Email: wayne.blair\_brown@daimler.com  
Personnel: Chief Fire Officer:1 - Station Officers:4 - Firemen:16 - Control Room Operator:2

**MINE RESCUE SERVICES (PTY) LTD**

(Mining)  
PO Box 1635  
Carletonville 2500  
Tel no (018) 781-1141/2  
Fax no (018) 781-1085  
Cell no 072 380 2548  
After hours tel no: (018) 771 7617  
Emergency: 082 852 4053 / 082 334 0504  
Chief Executive Officer: M Fourie  
Email: mannas@minerescue.co.za / admin@minerescue.co.za

**MONDI INDUSTRIAL FIRE & EMERGENCY SERVICES**

(Paper Mill)

**Merebank Mill Durban (KZN)**

Travancore Drive, Merebank, 4052  
Tel (031) 451 2729 / (035) 901 2093  
Email: ife@telkomsa.net  
Fire Officer: N Padayachee  
Tel no (031) 451 2702  
Cell no 084 610 8817  
Email: Neville.padayachee@mondigroup.co.za

Business Manager: V Munsamy

Tel no (035) 789 0249

Cell no 076 403 4742

Email: Vanessa.munsamy@ifes.co.za

**Richards Bay Mill (KZN)**

7 Western Arterial, Alton,  
Richards Bay, 3900  
PO Box 1551, Richards Bay, 3900  
Tel no (035) 902-2730  
Fax no (035) 902-2817  
Chief Fire Officer: E.Britz  
Email: etienne.britz@mondigroup.co.za  
Fire Officer Operations & Fire Prevention:  
Carine Steyn  
Email: carine.steyn@mondigroup.co.za  
Tel no (035) 902 2892  
Fire Officer Maintenance & Fire Prevention  
Blessing Mlungwana  
Email: blessing.mlungwana@mondigroup.co.za  
Tel no (035) 902 2540  
Shift Fire Officers: 4 Shift Firemen: 8  
SAQCC Fire Technicians: 3

**NATIONAL PETROLEUM REFINERS OF SOUTH AFRICA (PTY) LTD (NATREF)**

(Crude oil refiners)  
Jan Haak Rd Sasolburg  
PO Box 234  
Sasolburg 1947  
Tel no (016) 940-2782  
Fax no (016) 940-2775  
Fire Chief: Rory Hodgkinson  
Cell no 082 334 4911  
Email: rory.hodgkinson@natref.com  
Divisional Officer Fire Engineering: Joseph Meyer  
Email: joseph.meyer@natref.com  
Dayshift Fire Officer: F. Malebo  
Email: france.malebo@natref.com  
Full time fire fighters:21 - Auxillary fire fighters 60: - Trainees:8

**NECSA**

PO Box 582  
Pretoria 0001  
Tel no (012) 305-3333  
Fax no (012) 305-6362  
Chief Fire Officer: GS Venter  
Tel no (012) 305-6655  
Cell 082 809 2367  
Email: fire@necsa.co.za  
Senior Station Officer: A Gerber  
Cell: 082 807 9155  
Tel no (012) 305-6633  
Email: anton.gerber@necsa.co.za  
Personnel: 12 firemen

**NKOMATI MINE**

(Nickel Mining)  
P O Box 562, Machadodorp, 1170 Slaaihoek  
Farm 540JT, Waterval Boven District  
Health & Hygiene Superintendent:  
LJ Grobler  
Tel (013) 712 8200  
Fax: 013 712 8473  
Cell no: 0824632827  
Email: Lourens.grobler@nkomati.co.za

**NORTHAM PLATINUM LIMITED**

(Platinum mining)  
Farm 384KQ Zondereinde 0380  
PO Box 441  
Thabazimbi 0380  
Tel no (014) 784 3000  
Fax no 086 572 8702  
Manager Financial Services: MS Fourie  
Tel (014) 784 3001  
Fax: 086 572 8702  
Email: ifourie@norplats.co.za  
Safety Co-ordinator: S Phalatsi  
Tel no (014) 784-3179  
Cell no 0711748575  
Email: samuel.phalatsi@norplats.co.za

**PETRA DIAMONDS**

(Diamond mining)  
**Finch Mine**  
PO Box 7  
Lime Acres 8410  
Tel no (053) 305 5122  
Fax no (053) 305 5028  
Safety Manager & ER24: PA Nkuna  
Cell no 072 326 6863  
Email: Andy.Douglas@petradiamonds.com

**PETROSA NATIONAL OIL**

(GTL Refinery)  
1 Protea Place Fredman Drive  
Sandton  
Tel no (011) 201-5800  
Duinzicht Avenue Mossel Bay  
Private Bag X14  
Mossel Bay 6500  
Switchboard Cape Town:  
Tel no (021) 929 3000  
Switchboard Mossel Bay:  
Tel no (044) 601-3161/ 8400  
Emergency no (044) 601-2222  
Fax no (021) 929 3144  
Cell no 082 855 6540  
Email: petrosa@petrosa.co.za  
Fire Chief: Nthabiseng Makwela (Acting)  
Tel no (044) 601-3403  
E-mail: Nthabiseng.Makwela@petrosa.co.za  
Acting Training Officer: Nthabiseng Makwela

Tel no (044) 601-3160  
Email: Nthabiseng.Makwela@petrosa.co.za  
Operations Safety Manager: SM Malebese  
Tel no (044) 601 3407 / 2911  
Cell no 082 513 5599  
Email: nombuso.gumede@petrosa.co.za  
Personnel: 11 officers, 8 full-time firemen,  
120 volunteer fire fighters

**PIONEER FOODS**

(Wheat millers)  
24 Nichol Str Chamdor Krugersdorp 1739  
PO Box 4315 Luipaardsvlei 1743  
Tel no (011) 271 7300  
Email: caroline.byleveld@pioneerfoods.co.za  
Loss Control Manager: Nonhlanhla Pesa  
Email: Nonhlanhla.Pesa@pioneerfoods.co.za  
Personnel: 7 firemen

**PPC LIME LIMITED**

(Manufacturer lime)  
Private Bag Lime Acres 8410  
Risk Manager: Susan Vollenhoven  
Tel no (053) 385 8328  
Email: susan.vollenhoven@ppc.co.za  
Training Officer: S Segalwe  
Tel no (053) 385 8227  
Email: ssegalwe@ppc.co.za  
Personnel: 15 firemen, 2 nurses

**PUREGAS (PTY) LTD**

(Supplier of purified and blended gaseous hydrocarbon propellant, foam blowing products)  
4 Liebenberg Street Alrode  
PO Box 123884 Alrode 1451  
Tel no (011) 903 9760  
Fax no (011) 903 9766  
Safety Manager: Thomas Xaba  
Email: Thomas@puregas.co.za

**RICHARDS BAY COAL TERMINAL LTD**

(Coal exporting)  
South Dunes Richards Bay  
PO Box 56 Richards Bay 3900  
Tel no (035) 904-4911  
Fax no 086 632 8336  
Safety specialist officer: Bheki Ngcobo  
Tel no (035) 904-4001  
Cell 074 636 3499  
Email: Bngcobo@rbct.co.za  
HSE Manager: Sihle Shezi  
Tel no (035) 904 4102  
Cell 083 793 9644  
Email: sshenzi@rbct.co.za  
Manager: Security & Emergency  
Preparedness: Karen Johnstone  
Tel: 035 904 4000  
Cell 083 632 9000  
Email: kjohnstone@rbct.co.za  
ETD Section Manager: Ted Reddy  
Tel no (035) 904-4383  
Cell 067 059 1663  
Fax no 086 632 8311  
Email: preddy@rbct.co.za  
Personnel: proto team of 50 firemen,  
1 doctor, 1 paramedic, 4 nurses

**ROSSING URANIUM LTD INTERNATIONAL (RIO TINTO GROUP)**

(Mining)  
28 Hidipo Hamutenya Avenue,  
Private Bag 5005 Swakopmund Namibia

Tel no 00264 64 5202272  
Cell: 00264 81 481 2610  
Fax no 00264 64 5202281  
Safety Specialist: Michael Louw  
Email: Michael.Louw@riotinto.com  
Website: www.riotinto.com

**ROYAL BAFOKENG PLATINUM**

(Platinum Mine)  
Private Bag X82085  
Rustenburg 0300  
Head of SHER: P Coetzer  
Email: philipc@bafokengplatinum.co.za  
Tel no (014) 573 1585  
Fax no (014) 573 1585  
Rescue Coordinator: G v Greunen  
Email: georgevgv@bafokengplatinum.co.za  
**Bafokeng Rasimone Platinum Mine**  
Safety Manager: W Coleman  
Email: wesselc@bafokengplatinum.co.za  
**Styldrift Mine**  
Safety Manager: J Ngwenya  
Email: johnNO1@bafokengplatinum.co.za

**SAFRIPOL (PTY) LTD**

(Manufacturer plastic)  
Eugene Houdry Str Northern Industry  
Sasolburg PO Box 700 Sasolburg 1947  
Tel no (016) 970- 4000/4001  
Fax no (016) 970-4107  
SHEQ Manager: Dannie Von Benecke

**SAMANCOR LTD**

(Manganese mine)  
PO Box 3, Steelpoort, 1153  
SHEQ Specialist - Ventilation: Phuti Mphago  
Tel no (013) 230-7000 / 7121  
Fax: 086 668 1227

**SAMANCOR EASTERN CHROME MINES**

(Chrome mine)  
PO Box 2290 Burgersfort 1150  
Sheq Administrator Tel no (011) 249 4408  
Email : environmentalqueries@samancorcr.com  
SHEQ Specialist - Ventilation: Vacant  
Tell no (013) 230-7121

**SAMUELS OIL**

Postnet Suite 974 Private Bag X9013  
Ermelo 2350  
Head Office tel no (031) 358 3200  
SHEQ Manager: Vacant

**(SANRAL) SOUTH AFRICAN NATIONAL ROADS AGENCY LTD**

(Roads maintenance)  
Pretoria  
P O Box 415 Pretoria 0001  
Tel: 012 844 8000 Safety Manager: H Lucas  
Email: lucash@nra.co.za  
Menlyn Office  
Private Bag X17 Lynnwood Ridge Pretoria 0040  
Safety Manager: H Lucas  
Tel: 012 426 6200  
Email: lucash@nra.co.za  
Eastern Cape  
PO Box 27230 Greenacres Port Elizabeth 6000  
Tel no 041 398 3200  
Fax no (041) 492 0201  
Safety Administrator: H Lucas  
Email: lucash@nra.co.za 076 895 9662

*Kwazulu Natal*  
P O Box 100410, Scottsville 3209  
Tel no (033) 392 8100  
Safety Manager: H Lucas  
Email: lucash@nra.co.za

**SAPPI KRAFT**

(Paper mill)  
**Stanger Mill**  
PO Box 725 Stanger 4450  
Tel no (032) 437 2387  
Fax no (032) 551-1622  
Risk Control Superintendent: B Van Der Merwe  
Email: Brandon.lofter@sappi.com  
Training Manager: Chris Gengan  
Email: chris.gengan@sappi.com  
**Tugela Mill**  
Old Main Road Mandini 4490  
Private Bag x 6034, Mandini, 4490  
Tel no (032) 456-1111  
Fax no (032) 456-1484  
Supt. SHEQ Officer: D Vermaak  
Email: daanie.vermaak@sappi.com  
Training Manager: Tinus Erasmus  
Tel no (03) 279 6202  
Email: tinus.erasmus@sappi.com  
**Ngodwana Mill**  
Sappi Ngodwana, N4 Highway between Nelspruit & Waterval Boven 1209  
Private Bag X1001 Ngodwana 1209  
Switchboard No (013) 734 6239  
Tel no (013) 734-6111  
Fax no (013) 734-6535  
Fire Manager: Duncan Ballantyne  
Tel: 013 734 6222  
Email: Duncan.Ballantyne@sappi.com  
Training Manager: L Faul  
Tel no (013) 734 6291  
Fax no (013) 734 6535  
Email: Lance.Faul@sappi.com

**SAPREF - SHELL AND BP PETROLEUM REFINERIES (PTY) LTD**

(Petrol and oil refiners)  
No. 1 Refinery Road Prospecton Durban, 4000  
PO Box 3179 Durban 4000  
Tel no (031) 480-1352 / (031) 480 1292 / (031) 480 1660 / (031) 480 1606 / 1999  
Fax no (031) 480-1126  
Fax2Email: 086-241-5251  
Cell no 083 825 4475  
Chief Fire Officer /Manager Emergency Services: Kevin Govender  
E-mail: govenderke@sapref.com  
EMS Administartor: Vacant  
Tel no (031) 480 1352  
HSSE Manager: Mbulelo Yokwe  
Tel no (031) 480 1911  
Personnel: 10 professionals and 60 part time fire fighters, 24 paramedics and first aiders

**SASOL INFRACHEM**

(Petro-Chemical) SCI & Midland Sites  
Klasie Havenga St Sasolburg 1947  
PO Box 1, Sasolburg, 1947  
Tel no (016) 960-3048/9  
Fax no (016) 960-2545  
Manager Emergency Management: Ewart Radebe  
Personnel: 51 firefighters, 45 medically trained staff  
Fire Stations: 2

**SASOL MINING (PTY) LTD**

(Mining)  
Private Bag X1015  
Secunda 2302  
Tel no (017) 6143268  
Senior Ventilation Manager:  
AM Labuschagne  
Cell no 0825550704  
Email: inus.labuschagne@sasol.com

**SASOL SECUNDA EMERGENCY MANAGEMENT SERVICES**

(Petrochemical)  
Private Bag X1000, Secunda 2302  
Tel no (017) 610-2478 /610-6211  
Fax no (017) 610-4805  
Emergency Toll free Sasol SA hazmat enquiries and incidents: 0800 11 28 90  
Landline Tel no (017) 610 4444  
Chief Fire Officer: Andre Labuschagne  
Tel no (017) 610-3827  
Fax no (017) 522-6866  
Cell no 076 862 3160  
Email: andre.labuschagne@sasol.com  
Manager: Operations: Zarto Williams  
Email: Zarto.williams@sasol.com  
Tel no (017) 610 4775  
Manager: Fire Engineering and preparedness: Boel Engelbrecht  
Email: boel.engelbrecht@sasol.com  
Tel (017) 610 2192  
Cell 082 332 9454  
Manager: Maintenance: Planning & Logistics:  
Paul Matenche  
Email: paul.matenche@sasol.com  
Manager - Training Academy: Boikanyo Motlogelwa  
Tel: 017 610 8212  
Cell no 060 997 5454  
Email: Boikanyo.motlogelwa@sasol.com  
Personnel: 120 Full time: Operational staff - 94, Training, Maintenance, Engineering & Admin Staff - 26  
Area of Designation:  
Primary industrial area - 8,5 sqkm.  
Total area of designation including mines: 250sqkm

**SASOL TECHNOLOGY (PROCESS ENGINEERING)**

Private Bag X1034 Secunda 2302  
Tel (017) 619 2177  
Fax (011) 522 7822  
Fire and Emergency Specialist - Consultant to the engineering house of Sasol: Gert Lubbe  
Cell no 072-637-6005  
Email: gert.lubbe@sasol.com

**SCAW METALS A DIVISION OF AMIC INDUSTRIES**

(Foundries, engineering & rolling mills)  
Blackreef Rd Dinwiddie Germiston  
PO Box 61721 Marshalltown 2107  
Tel (011) 842-9000  
Fax no (011) 842-9719 / 9703  
Group Safety and Industrial Environment Manager: Jurgen Theiss  
Tel (011) 842-9582  
Email: jtheiss@scaw.co.za  
Personnel: 20 firemen, 1 doctor, 4 sisters, 8

nurses

**SIBANYE GOLD SHARED SERVICES**

(Mining)  
Libanon Business Park  
1 Hospital Rd Westonaria 1780  
Private Bag X2054  
Carltonville 2500  
Tel no (011) 278 9790  
Fax no 086 520 0338  
SHEQ Manager: GA Claassen

**SUN CITY FIRE & EMS DEPARTMENT**

(Hotel and casino holiday resort)  
Sun City Complex South Village  
Farm Doornhoek N910jk Mankwe 0316  
PO Box 53 Sun City 0316  
Sun City Emergency and Security Control Room  
Tel no (014) 557 9111  
Tel no (014) 557 1111/2/3/4/5  
Emergency Services Coordinator: Natasha Brits

Tel no (014) 557 1116  
Fax no (014) 557 3723  
Email: natasha.brits@suninternational.com  
Chief Fire Officer: Eddy Molema  
Tel no (014) 557 1727  
Fax no (014) 557 3723  
Email: eddy.molema@suninternational.com  
Cell no 082 506 9825  
Health & Safety / Contractor Compliance / Induction - Safety Officer: George Dioke  
Tel no (014) 557-1717  
Cell no 082-908-2179  
Email: george.dioke@suninternational.com  
Area protecting: 28 829 sq kms (hotel industry),  
22 258 (nature reserve), small industry 1 225  
Population: ± 50 000  
Emergency calls:- Rescues/Recoveries:89 -  
Special service:364 - Grass/veld fires:30 -  
Vehicle accidents:78 - Building fires:26 -  
Dwelling fires:15 - Fatalities:25 - Standby for fireworks, LPG decanting, shows:430  
Ambulance calls: 2456  
Value of property destroyed by fire: R5 million  
Mileage of ambulances per annum: 54 000 kms  
Personnel: Officer: 1 Chief Fire Officer; 1 Shift Manager; 2 Leading Emergency Technicians; 14 Emergency Technicians; 1 Emergency Services Coordinator  
Budget: R2 200 000.00

**TAU LEKOA GOLD MINE**

(Mining)  
Goedgenoeg Farm, 2619 Orkney, Northwest  
Private Bag X800 Stilfontein 2550  
Tel no (018) 473-7063  
Admin: Anita Savvas  
Email: anitas@taulekkoa.co.za  
SHE Officer: Francois Mathee  
Tel no (018) 473-7057  
Email: francoism@taulekkoa.co.za

**THE SOUTH AFRICAN BREWERIES MALTINGS**

(Member of AB Indev)  
(Malting of barley for beer brewing purposes)  
Bredasdorp Rd Caledon  
PO Box 27 Caledon 7230

Tel no (028) 214-3100  
Fax no 086 646 7208  
Safety Manager: H Swart  
Tel no (028) 214 3232  
Cell no: 083527 8070  
Email: hennie.swart@za.sabmiller.com  
Personnel: 30 firemen

**TOTAL SOUTH AFRICA (PTY) LTD**

(Manufacturers and sells petroleum and oil)  
**Head Quarters Gauteng**  
3 Biermann Avenue, Rosebank  
Tel no (011) 778-2000 / 2203  
Fax no 086-680-5000  
HSEQ Manager: Merusha Govender  
Email: Merusha.Govender@total.com  
**Durban**  
PO Box 21023 Bluff 4036  
Tel no (031) 466 9440  
HSE Manager: Cassim Kader  
Email: Cassim.Kader@total.co.za

**TRANSNET ENGINEERING**

(A manufacturing and repair facility for locomotives, rolling stock, components, and container trailers.)  
Head Office: Kilner Park Pretoria  
PO Box 4951 Durban 4000  
311 Solomon Mahlangu Drive, Durban (Major repair facilities at Koedoespoort, Germiston, Langlaagte, Uitenhague, Salt River)  
Fire Co ordinator: Elizabeth Govender  
Tel no (031) 361-4087  
Fax (031) 361-4163  
Email: Elizabeth.govender@transnet.net  
Personnel: 6 man fire fighting team and first aid fire fighting teams in workshops

**TRANSNET FREIGHT RAIL HAZMAT FIRE AND EMERGENCY MANAGEMENT ENTERPRISE RISK MANAGEMENT**

**Corporate Office Johannesburg**  
PO Box 31084 Braamfontein 2017  
Functional Head: HL Waldeck  
Tel no (011) 584- 0531  
Email: Herman.Waldeck@transnet.net  
Hazmat Fire and Emergency Management Specialist: P Naidoo  
Tel no (011) 584- 0532  
Email: Pete.Naidoo@transnet.net  
Hazmat Fire and Emergency Management Consultant; Dangerous goods & Disaster management: Steven Nel  
Tel no (011) 584 -0552  
Email: Steven.Nel@transnet.net

**Western region**

Manager: J Jansen  
Email: Johan.Jansen@transnet.net  
Tel no (053) 838-3166  
Cell no 083 284 3616  
**Port Elizabeth**  
PO Box 324 Port Elizabeth 6000  
Tel no: (041) 507-4160  
Fax no (041) 507-4161  
Chief Fire Officer: A Ludik  
Cell no 083 286 1398  
E-mail: Andrew.Ludik@transnet.net  
**Western Cape Bellville**  
PO Box 811 Sanlamhof 7532  
Caledon West Street Bellville  
Tel no (021) 940-2961/2  
Fax no (021) 940-2983

Chief Fire Officer: Moegamat Arendse  
Cell no 083 277 2862  
Email: Moegamat.Arendse@transnet.net  
**Northern Region**  
**Northern Cape - Kimberley**  
PO Box 620 Kimberley 8300  
Tel no (053) 838-3166  
Fax no (053) 838 3059  
Cell no 083 284 3616  
Manager: Johan Jansen  
Email: Johan.Jansen@transnet.net  
**Free State**

PO Box 4413, Bloemfontein 9300  
Tel no 051 408 2000  
Fax no (051) 408-4487  
Senior Fire Officer: Ndooyisile Mkhiwane  
Email: Ndooyisile.Mkhiwane@transnet.net  
**Central Region**  
Manager: Hamish Otto  
Tel: 033 897 2155  
Cell 083 286 2803

**Gauteng Sentra Rand**

PO Box 8217 Putfontein 1513  
Chief Fire Officer: J Spogter  
Cell no 083 258 3289  
Email: jimmy.spogter@transnet.net  
Tel no (011) 960-2100  
Fax no (011) 960-2555

**Kwazulu Natal Durban**

PO Box 61642 Bishops Gate 4008  
Chief Fire Officer: Ashok Babulall  
Tel: 031 361 4047  
Cell no 083 286 2803  
Email: ashok.babulall@transnet.net  
PO Box 61642 Bishops Gate 4008

**Eastern region**

Manager: Simo Khanyi  
Cell no 083-459-8600  
Email: simo.khanyi@transnet.net  
**Northern Kwazulu Natal Empangeni**  
PO Box 1299 Empangeni 3880  
Chief Fire Officer : Philile Mahlase  
Cell no 083 564 5313  
Email: Philile.Mahlase@transnet.net  
Tel no (035) 906-7378  
Fax no (035) 906-7365  
**Northern Gauteng Pretoria**  
P O Box 637 Pretoria, 0001  
Senior Fire Officer: JM Dippenaar  
Email: Hansie.Dippenaar@transnet.net  
Tel no 315 8096  
Cell no 083 379 0284

**TRANSNET NATIONAL PORTS AUTHORITY OF SOUTH AFRICA**

**Port of Durban**  
Fire Department, Pier 1, 980 Bayhead Rd Durban 4000  
PO Box 1027 Durban 4000  
Tel no (031) 361-6560  
Emergency (031) 361- 6333  
Island View Office Tel no (031) 361-6463  
Fax (031) 361-6772  
Fire Control Fax no (031) 361-6439  
Chief Fire Officer: E.Zondi  
Tel: 031 361 6548  
Fax: 031 361 6439  
Cell no 083 215 8371  
Email eric.zondi@transnet.net  
Senior Fire Officer: Indrin Naidoo  
Tel: 031 361 6441

Cell no 083 410 4218  
Email Indrin.Naidoo@transnet.net  
Area protecting: Port of Durban  
Population: Approx 12 000  
Emergency calls: Fire:27 - Hazmat:12 - Rescure / injury:09 - False alarm:06 - Spillages:22  
Value of property destroyed by fire: R6,3 million  
Mileage of vehicles per annum: 227 880 kms  
Personnel:- Officers:9 - Full-time firemen:55  
Budget:R 21.6 million

**Port of Richards Bay**

PO Box 181 Richards Bay 3900  
Tel no (035) 905-3335  
Fax no (035) 905-3910  
Standby Cell no 083 708 0830  
Chief Fire Officer: NG Moodley  
Cell 083 708 0830  
Email: Neelan.Moodley@transnet.net  
Fire Officer: Simphiwe Sithole  
Email: Simphiwe.Sithole@transnet.net  
Tel no 035 905 3135  
Fire Officer: S Maistry  
Tel no 035 905 3135  
Email: Dees.Maistry@transnet.net  
Fire Officer: Nkosinathi Qwabe  
Tel no 035 905 3135  
Email: Nkosinathi.Qwabe@transnet.net  
Training Officer: L Xulu  
Tel no (035) 905 3194  
Email: Lungile.Xulu@transnet.net  
**Transnet Freight Rail, Port Elizabeth**  
PO Box 324 Port Elizabeth 6001  
Switchboard tel no (041)507 4160/4162  
Control Office no (041) 507 4160/4162  
Fax no (041) 507 4161  
Cell: 083 286 1398  
Chief Fire Officer: Andrew Ludik  
Email: Andrew.ludik@transnet.net  
Tel no (041) 507-4160  
Cell: 083-286-1398  
Fax no (041) 507-4161  
Training Manager: D Goliath  
Tel no (041) 507 1914  
Fax no (041) 507 1904  
Email: david.goliath@transnet.net

**Port of Saldanha**

Private Bag X1 National Ports Authority, Saldanha 7395  
Tel no (022) 703-4338  
Fax no (022) 703-4403  
Standby cell: 073 185 7205  
Chief Fire Officer: Vacant  
Cell 083 704 0120  
Tel no (022) 703 4330  
Fire Officer / Legal Compliance: C Titus  
Tel no (022) 703 5427  
Cell: 073 185 7205  
Email: christo.titus@transnet.net  
**Port of Cape Town**  
PO Box 4245 Cape Town 8000  
Switchboard Tel no 021 449 3901  
Tel no (021) 449-5848 / 5804  
Fax no (021) 449- 3973  
Chief Fire Officer: Johnny Loji  
Cell no 083 561 8803  
Email: Johnny.loji@transnet.net  
Fire Training Manager: Andile Mpoki  
Email: Andile.Mpoki@transnet.net

**VIRGINIA AIRPORT**

(Airport)  
220 Fairway Durban North  
PO Box 201444  
Durban North 4016  
Tel no (031) 563-7101  
Fax no (031) 563-7138  
Airport Manager: G Bryce  
Cell no 084 668 8569  
Email: glen@indiza.biz  
Chief Fire Officer: David Twine  
Cell 083-922-5941  
Email: david@indiza.biz  
Personnel: 3 fire fighters per shift (2 shifts)  
**Richards Bay Airport**  
(Airport)  
Fish Eagle Flight Richards Bay 3900  
Suite 75 P/Bag X1040  
Richards Bay 3900  
Tel no (035) 786 0119 / (035) 789 9630  
Fax no (035) 786 0296  
Airport Manager: Oscar Nzima  
Cell no 076 062 3058  
Email: oscar@indiza.biz  
Chief Fire Officer: Vusi Khanyile  
Cell 073-719-5769  
Email: vusi@indiza.biz  
Personnel: 5 fire fighters per shift (2 shifts),1 officer  
**Indiza Fire and Training Services**  
(Training)  
Stoneridge Office Park, 08 Greenstone Place, Greenstone Hill, Edenvale, 1609  
P O Box 55389  
Northlands 2116  
Tel no (011) 524 8400  
Fax no (011) 524 8498  
Director: Adrian Cilliers  
Cell no 082 467 1506  
Email: riaan@indiza.biz  
Durban Branch tel no: (035) 789 9630

**VOLKSWAGEN SOUTH AFRICA**

Service supplied by Algoabay Fire Services cc  
Tel no (041) 994 4333  
Chief Fire Officer: H Basson  
Tel: 041 994 4333  
Cell: 076 383 6378  
Email: basso08@vwsa.co.za

**WALTER SISULU UNIVERSITY**

(University Campus)  
Nelson Mandela Drive Mthatha 5100  
Private Bag X1  
Mthatha, 5100  
Chief Fire Officer: R Chopiso  
Tel no (047) 502-2517  
Fax no 086-733-8024  
Cell no 082-040-8864  
Email: rchopiso@wsu.ac.za  
Fire Fighter: L Sigaba Likhaya  
Tel no (047) 502-2517  
Cell no 073-788-5637  
Email: sigabalm@webmail.co.za

**WATERBERG FIRE & RESCUE**

Corner Oktaan & Nelson Mandela Drive,  
Industrial Site, Modimolle  
PO Box 700  
Vaalwater 0530  
Tel: 082 807 8152 / 0800 111 660

Fax: (014) 755-4080  
Control Centre: 082 807 8152  
Ambulance: 014 718 3800  
Fire Chief Officer: Dan Mokonyama (District)  
Email: dmokonyama@waterberg.gov.za  
Fire Chief Officer: Arie Klaasen (Local Municipality) Tel: 014 718 3380  
Email: bafanakhosa@gmail.com / johnkla@live.com  
Size of area: ± 2500 sq kms Population: ± 1000  
Volunteer fire fighters:10

#### **WATER AFFAIRS AND FORESTRY DEPARTMENT**

*National*  
Switchboard: 012 336 7500  
Chief Director General: Deborah Mochotlhi  
Tel no (012) 336-6990  
Fax no (012) 326-8850  
Email: centralp@dws.gov.za  
Chief Information Officer (CIO): Arthur Kekana  
Tel no (012) 336 8701  
Fax no (012) 336 7321  
Acting Head of Communications:  
Motlhaolwa Motsamai  
Tel no (012) 336 7957  
Email: MotlhaolwaM@dws.gov.za  
Departmental Spokesperson: Sputnik Ratau  
Tel no (012) 336 6813  
Cell: 082 874 2942  
Email: RatauS@dws.gov.za  
Spokesperson to the Minister: Mtobeli Mxotwa  
Tel no (012) 336 8729  
Cell no 061 243 6329  
Email: MtobeliM@dws.gov.za  
Office of the Deputy Minister  
Head of Office: Beza Ntshona  
Tel no (012) 336 8889  
Cell no 072 311 3628E  
Email: NtshonaB@dws.gov.za  
Media Liaison Officer: Luvo Dumse  
Tel no (012) 336 8843  
Cell no 073 050 7717  
Email: DumseL@dws.gov.za  
**Eastern Cape**  
*Department of Water and Sanitation*  
2 Hargreaves Ave, King Williams Town  
Private Bag X7485 King Williams Town 5600  
Tel no (043) 604-5400  
Fax no (043) 642 6032  
Chief Director: Portia Makhanya  
Email: makhanyap@dws.gov.za  
Training Officer: Vacant  
*Port Elizabeth*  
Lion Roars Office Park Building, 50 Heugh Road, Walmer, 6070  
PO Box 5501, Walmer, 6065  
Manager : Southern Operations (NWRI)  
National Water Resource Infrastructure:  
Mzukisi Maneli  
Tel no 041 501 0740  
Email: manelim@dws.gov.za  
Training Officer: Kholiswa Sohuma  
Tel no 043 604 5400  
Email: sohumak@dws.gov.za  
For Invitations: Email: Zenzilea@dws.gov.za / Mtid@dws.gov.za

For info: Email: gcilitshanaz@dws.gov.za  
**Free State**  
*Department of Water and Sanitation*  
2nd Floor, Sanlam Plaza, Cnr Charlotte Maxeke & East Burger Sts, Bloemfontein  
PO Box 528 Bloemfontein 9300  
Tel (051) 405-9000 Fax (051) 430-8146  
Chief Director: Dr TP Ntllil  
Email: ntllit@dws.gov.za  
Cell no 082-803-3204

**Gauteng**  
*Department of Water and Sanitation*  
15th Floor, Bothongo Plaza East Building, 285 Francis Baard St Pretoria  
Private Bag x 995, Pretoria, 0001  
Tel no (012) 392-1300/1301  
Fax no 086 274 3717  
Provincial Head: Sibusiso Mthembu  
Tel no (012) 392-1300  
Cell no 082 615 4730  
Email: mthembusi@dws.gov.za  
**KwaZulu-Natal**  
*Department of Agriculture, Forestry and Fisheries*  
185 Langalibalele St, Pietermaritzburg  
Private Bag X9029 Pietermaritzburg 3200  
Tel no (033) 392 7700  
Fax no (033) 345-1210 / 086 650 0747  
Chief Director: Ashley Starkey  
Tel no (033) 336 2700  
Fax no (033) 336 2849  
Cell no 082 809 5892  
Email: StarkeyA@dws.gov.za  
Chief Training Officer: P Ngcobo  
Tel no (033) 392 7777  
Cell no 082 890 6090  
Fax no 086 238 9992  
Email: PatrickNg@daff.gov.za

**Limpopo**  
*Department of Water and Sanitation*  
*Azmo Place*  
Azmo Place, 49 Joubert St, Polokwane, 0700  
Private Bag X9506, Polokwane, 0700  
Tel no (015) 290-1208  
Fax no (015) 290 2295  
Acting Chief Director: Lesiba Tloubatla  
Tel no (015) 290-1200  
Fax no 015 295 2295  
Cell no 082 928 3979  
Email: tloubatlal@dws.gov.za

**Mpumalanga**  
*Department of Water Sanitation*  
Prorom Bld, Cnr Brown & Paul Kruger Sts, Nelspruit  
Private Bag X11259 Nelspruit 1200  
Tel no (013)759-7300/7310/7586  
Fax no (013) 759-7525  
Chief Director: Fikile Guma  
Tel no (013) 759-7311  
Cell no 082 327 5886  
Email: gumaf@dws.gov.za  
Training Officer: Princess Nxumalo  
Tel no (013)759-7338  
Email: nxumalop@dws.gov.za  
Acting Operations Corporate Services: Adam Lessing  
Tel no (013) 759-7302  
Email: lessinga@dws.gov.za

**North West**  
*Department of Water and Sanitation*

99 Ground Floor, Mega City Shopping Centre, Corner Dr James Moroka Drive & Sekame Road, Mmabatho  
Private Bag X5 Mmabatho 2735  
Tel no (018) 387 9500  
Fax no (018) 392-2998  
Director: Dr Tseliso Ntllil  
Email: NtllilT@dws.gov.za  
Tel no (018) 387-9500  
Cell no 082 803 3204  
Training Officer: E Huma  
Tel no (018) 387 9590  
Email: humae@dws.gov.za  
**Northern Cape**  
*Water Affairs and Sanitation Department*  
28 Central Rd, Beaconsfield, Kimberley  
Private Bag X6101 Kimberley 8300  
Tel no (053) 830-8800 / 6 / 7600  
Fax no (053) 831 4534  
Chief Director: A Abrahams  
Email: abrahamsa@dws.gov.za  
Tel no (053) 830-8803  
Cell no 082 883 6741  
Training Officer: Suzette Gysman  
Tel no (053) 830 8843  
Email: gysmans@dws.gov.za

**Southern Cape**  
*Department of Agriculture, Forestry and Fisheries*  
27 Main Str, Demar Building, Knysna  
Private Bag X12 Knysna 6570  
Tel no (044) 302 6900 Fax no (044) 382-5461  
Chief Director: Sarel Ndou  
Email: NaomiT@daff.gov.za  
**Western Cape**  
*Department of Water and Sanitation*  
3 Blackenberg Rd Bellville  
Private Bag X16 Sanlamhof Bellville 7532  
Tel no (021) 941 6000  
Fax no (021) 950-6100  
Chief Director: R Khan  
Email: khanr@dws.gov.za  
Tel no (021) 941-6000  
Cell no 082-809-2218

#### **WELGEMEEND COLLIERY**

(Coal Mining)  
PO Box 4541 Middelburg1050  
Safety Superintendent: HJ Boonzaaier  
Tel no (013) 656 3732/3733  
Fax no (013) 656 3614  
Cell no 082 495 9530 / 082 081 8349  
Email: drienieb@mbuyelocoal.com

#### **WILMAR CONTINENTAL EDIBLE OILS AND FATS (PTY) LTD**

(Manufacturer edible oils, Margarine, Mayonnaise, Dips and Baking Fats)  
144 Main Reef Rd Randfontein  
PO Box 208 Randfontein 1760  
Tel no (011) 278-0300  
Fax no (011) 693 1422  
SHERQ Manager: Monique Snyders  
Email: snydersm@wilmarcontinental.com  
HR Manager: Cecilia Maselane  
Tel no (011) 278 0300  
Fax no (011) 011 692 2911  
Email: maselane@wilmarcontinental.com

## DEPARTMENT OF DEFENCE EMERGENCY MANAGEMENT SERVICES

#### **DEPARTMENT OF DEFENCE CHIEF LOGISTICS**

*SSO Fire and Rescue Services:*  
Colonel K Naicker  
Tel no (012) 402 2658  
Fax no (012) 402 2653  
Email: kaynaick@gmail.com  
*Department of Defence, Chief of Logistics, Directorate Engineering Support Services (DESS)*  
Private Bag X319  
Pretoria, 0001  
*Department of Defence (Logistic Support Formation)*  
SO1 Fire and Rescue Services: Major MJ Brown  
Tel no (012) 671-0339  
Fax no (012) 671-0247  
*Department of Defence, Logistic Support Formation*  
Private Bag x1023  
Lyttelton, 0143

#### **SA NAVY**

*Naval Base Simonstown*  
Warrant Officer Ngcobo  
Tel: (021) 787-4792  
Fax: (021) 787-4155  
Private Bag X1  
Simon's Town 7995  
*Army Support Base Naboomspruit*  
Fire Chief: Warrant Officer JC Bester  
Tel: (014) 743-9606/ 9533  
Comanding Officer: Colonel AK Morokane  
Tel: (014) 743-9500/02  
Fax: (014) 743-9510  
Private Bag X91  
Naboomspruit 0560  
*Army Support Base Mpumalanga*  
Warrant Officer JM Mohammed  
Tel: (013) 756-2084  
Fax: (013) 756-2200  
Private Bag X11227  
Nelspruit 1200  
*Army Support Base Johannesburg*  
Warrant Officer Major Gwai  
Tel: (011) 212-5874/ 5826/5510  
Fax: (011) 212-5777  
Private Bag X19  
Lenasia 1820  
*Army Support Base Limpopo*  
Warrant Officer Major Malebati  
Tel: (015) 299-3349  
Fax: (015) 299 3355  
Private Bag X9304  
Polokwane 0700  
*Army Support Base Wallmannsthal*  
Warrant Officer: Modise (Fire Brigade)  
Tel: (012) 529-1500  
Fax: (012) 529-0414  
Wallmannsthal MOSD  
Private Bag X4  
Pryramid, 0120  
*Army Support Base Kimberley*  
Sergeant Major Kramer  
Tel: (053) 830-3028 / 3029 / 3174  
Fax: (053) 830-3019  
Private Bag X5056  
Diskobolos 8325  
*School of Engineers*  
Warrant Officer Roman (EMS)  
Cell no 073 402 0116  
Tel: (056) 216-2163 / 2499  
Private Bag X20  
Kroonstad 9500  
*Army Support Base Kwa-Zulu Natal*  
Sergeant Major RSM Nzimela  
Tel: (036) 271-3040  
Cell no: 079 810 4270  
Fax: (036) 271-3140  
Private Bag X9914  
Ladysmith 3370  
*Army Support Base Bloemfontein*  
Fire Coordinator: Warrant Officer Sergeant Major JH Wese  
Tel: (051) 402-1095/1097  
Fax: (051) 402 1003  
Private Bag x20599  
Tempe,  
Bloemfontein 9315  
*Army Support Base Eastern Cape*  
Warrant Officer Class J. Gouws  
Email: gouwsj@gmail.com  
Tel: (041) 505-1531  
Fax: (041) 505-1530  
P.O. Box 13419  
Humewood 6015 Port Elizabeth  
*Army Support Base Oudtshoorn*  
Acting Staff Sergeant Officer (Fire Chief): Z Makalima  
Tel: (044) 203-4012 / 4062  
Fax: (044) 203-4012  
Private Bag X643  
Oudtshoorn 6620  
*Army Support Base Western Cape*  
Fire Chief: Staff Sergeant Officer: BA Bitterbes  
Tel: (021) 787-1619/1572  
Fax: (021) 787-1619  
Private Bag X1  
Kenwyn 7790  
*93 Ammunition Depot*  
Chief Fire Officer: Sergeant S Appolis  
Tel: (053) 456-5051/26/74  
Fax: (053) 456-5044/26  
Private Bag X1  
Jan Kempdorp, 8550

#### **AIR FORCE**

*Directorate Base Support Systems*  
Staff Officer Fire Training: N Lalla  
Tel: (012) 312-2531  
Fax: (012) 312-1182 / 2707  
Force Preparation Fire and Rescue: Warrant Officer 1 KM Kutu  
Tel: (012) 312-2969  
Fax: (012) 312-1182  
Project Manager: Warrant Officer 1 MK Pillay  
Tel: (012) 312-1053  
Fax: (012) 312-1182

*Directorate Education Training and Development*  
Staff Officer Fire Training: Warrant Officer 1 PM Matseba  
Tel: (012) 312-2811  
Email: sparksmatseba@gmail.com  
*Military Aviation Rescue and Fire Fighting School (MARFFS)*  
Captain DM Geca  
Tel: (012) 672-5022  
*Air Force Base Langebaanweg*  
Fire Chief: Warrant Officer 1 D Bessinger  
Tel: (022) 706-2317/2256/2206/2173  
Fax: (022) 706-2168  
Private Bag X01  
Langebaanweg 7375  
*Air Force Base Makhado*  
Fire Chief: Warrant Officer J Jansen  
Emergency: (015) 577-2104  
Tel: (015) 577-2104/3  
Fax: (015) 577-2711  
Private Bag X2010  
Makhado 0920  
*Air Force Base Durban*  
Fire Chief: Warrant Officer 2 K Pillay  
Tel: (031) 450-4943/4977  
Fax: (031) 450-4730  
Cell: 074 176 6378  
PO Box 1120  
Amanzimtoti 4125  
*Air Force Base Ysterplaat*  
Fire Chief: Warrant Officer 1 J. Wilson  
Tel: (021) 508-6382/6266  
Fax: (021) 508-6154/6405  
Private Bag X4  
Ysterplaat Air Force Base,  
Cape Town 7425  
*Air Force Base Overberg*  
Fire Chief: Warrant Officer 1 J.A. Jacobs  
Tel: (028) 425-4088/9  
Fax: (028) 425-4087  
Private Bag X14  
Bredasdorp 7280  
*Air Force Base Waterkloof/Swartkops*  
Air command unit  
Fire Chief: Major Erasmus  
Tel: (012) 672-4022 / 3925  
Fax: (012) 672-4162  
Private Bag X1001  
Lyttelton 0140  
*Air Force Base Hoedspruit*  
Fire Chief: Warrant Officer 1 KJ Moabi  
Tel: (015) 799-2174/2197  
Fax: (015) 799-2491  
Private Bag X504  
Hoedspruit 1380  
*Air Force Base Bloemfontein*  
Fire Chief: Warrant Officer 1 Parker  
Fire Manager: Warrant Officer 02 Lukas Freeman  
Tel: (051) 405-6121/22  
Fax: (051) 405-6349  
PO Box 20608  
Bloemfontein 9300

# DEPARTMENT OF HEALTH EMERGENCY MEDICAL SERVICES

## EASTERN CAPE

Private Bag 27667  
Port Elizabeth, 6057  
Tel no 041 408 8151  
Fax no 041 408 8176  
Director EMS: HJ Truter  
Tel: 041 395 9502  
Email: h.truter704@gmail.com  
Sub District Manager- Operations:  
Brandon Metune  
Tel: 041 395 9504  
Cell no 083 378 0570  
Email: ansdup45@gmail.com  
Principal EMS College: Pieter Huysamen  
(Acting)  
Tel no (041)453 0911  
Email: Pieter.Huysamen@ehealth.gov.za  
DN Hospital Complex Zwide  
Port Elizabeth 6000  
*Training Department*  
Tel no (041) 408 8524  
Fax no (041) 456 1685  
Head of Training: Monde Feni  
Email: Monde.Feni@impilo.ecprov.gov.za

## FREE STATE

P O Box 227  
Bloemfontein, 9300  
Old Mutuary Building, 21 James Bick Str,  
Welgehof, Bloemfontein 9300  
Tel no (051)412 0164  
Fax no 051 430 6632  
Director: Dr RJ Khoali  
Email: khoalirj@fshealth.gov.za

## GAUTENG

Tel no (011) 564-2001  
Fax no (011) 564-2021  
PO Box 8311  
Halfway House 1685  
Growth Point Business Park, Continuity SA  
Building, Unit 4, Cnr Old Pretoria Rd &  
Tonetti Str, Midrand  
CEO: Arnold Malotana  
Tel: 011 564 2002  
Cell no 082 807 6867  
Email: Arnold.Malotana@gauteng.gov.za  
Director: Kgati Malebana  
Tel: 011 564 2002  
Email: Kgati.Malebana@gauteng.gov.za  
Deputy Director Operations: Colin Errakiah  
Tel no (011) 564-2053  
Email: colin.errakiah@gauteng.gov.za  
District Managers: City of Johannesburg  
- Donald Baloyi  
Email: Donald.Baloyi@gauteng.gov.za  
Ekurhuleni - Anna Lelaka  
Email: Annikie.Lelaka@gauteng.gov.za  
Sedibeng - Andrew Mosiane  
Email: Andrew.Mosiane@gauteng.gov.za  
Tshwane - Sipho Sithole  
Email: Sipho.Sithole@gauteng.gov.za  
West Rand - Harry Mokoena  
Email: Harry.Mokoena@gauteng.gov.za

## KWAZULU-NATAL

Private Bag X9051  
Pietermaritzburg 3200  
121 Chief Albert Luthuli Str Pietermaritzburg  
Tel no (033) 395 2111  
Fax no (033) 846 7278  
Head of Department: Dr M Gumede (Acting)  
Tel no 033 395 3176 / 2799  
Email: Beatrice.kayonga@kznhealth.gov.za

## LIMPOPO

Private Bag X9553  
Polokwane 0700  
58 Schoeman Street 6th Floor 604  
Rentmeester Building Polokwane 0700  
Tel no (015) 293 6000  
Control Centre Tel no (015) 285 6700 / 6755  
Switchboard tel no (015) 285 6700  
Fax no (015) 295-2990  
Senior Operational Manager: Mr Setumo  
Tel no (015) 285 6755/64  
Fax no (015) 295-2990  
Cell no 082 534 8901

## MPUMALANGA

Private Bag X11285  
Nelspruit 1200  
Building 3 Government Complex  
Government Boulevard Riverside White River  
Rd 1200 Nelspruit  
Tel no (013) 766-3412  
Fax no 086 500 5305  
Director: Dr MC Sibanda  
Email: clives@mpuhealth.gov.za  
Operational Manager: Mr AJ Dreyer  
Email: jacobusd@mpuhealth.gov.za  
Cell no 082 440 0802

## NORTHERN CAPE

Private Bag X5049  
Kimberley 8300  
30 Memorial Rd, Delgravia, Kimberley 8301  
Director: EMS,PPTS & DM: M Ntintelo  
Tel no (053) 831 2884

Fax no (053) 831 7645  
Email: mntintelo@ncpg.gov.za  
Operational Manager: Mr R Dreyer  
Cell no 083 895 0154  
Email: rdreyer@ncpg.gov.za

## NORTH-WEST

Geo Science Building, Ngaka Modiri  
Molema Rd Montshiwa 2735  
Private Bag X 2058  
Mmabatho, 2735  
Tel no (018) 384-8124  
Fax no (018) 384-8157  
Cell no 082 335 6034  
Manager: Mr B Redlinghys  
Email: bredlinghys@nwpg.gov.za  
Assistant Manager: Mr SA Bokala  
Tel no (028) 447 5007  
Email: abokala@nwpg.gov.za

## WESTERN CAPE

Private Bag X 24  
Bellville 7535  
Metro Emergency Medical Services  
Mike Pienaar Boulevard Bellville  
Tel no (021) 508 4523  
Fax no (021) 945 4796  
Director: S De Vries  
Email: shaheem.devries@westerncape.gov.za  
Principal: K Moodley  
Email: kuben.moodley@westerncape.gov.za  
Provincial Manager: Operations: S Taylor  
Email: stewart.taylor@westerncape.gov.za  
Tel no (021) 508 4504  
Provincial Manager: HealthNet: A Ahmed  
Email: abubhaker.ahmed@westerncape.gov.za  
Tel no (021) 508 4502  
Provincial Manager: Rescue: N Van  
Rensburg  
Email: neville.vanrensburg@westerncape.gov.za  
Tel no (021) 938 6271

## NATIONAL DISASTER MANAGEMENT MEMBERS

### NDMCC

Head: NDMC/DCoG: Dr Mmaphaka Tau  
Tel no 012 848 4601 Cell no 082 052 9311  
Email: MmaphakaT@ndmc.gov.za  
Executive Assistant to the Head of NDMC:  
Megan Louw  
Tel no 012 848 4602  
Cell no 082 312 3090  
Email: MeganL@ndmc.gov.za  
Executive Manager: Legislation and Policy  
Management: Anè Bruwer  
Tel no 012 848 4607  
Cell 084 570 7655  
Fax no 012 334 0810  
Email: AneB@ndmc.gov.za  
Jurgens Dyssel

Tel no 012 848 4608  
Cell no 082 495 1820  
Pumeza Tyali  
Tel no 012 848 4610  
Fax no 086 773 4537  
Email: pumezaT@ndmc.gov.za  
Executive Manager: Disaster Risk Reduction  
Capacity Building and Intervention: Moddy  
Radikonyana  
Tel no 012 848 4619  
Cell 082 979 4294  
Email: ModdyR@ndmc.gov.za  
Director: Fire Services: Dr Moses Khangale  
Tel no 012 848 4612  
Cell 072 037 7055  
Email: mosesk@ndmc.gov.za

### EASTERN CAPE PROVINCE DEPARTMENT OF LOCAL GOVERNMENT *(Department of Cooperative Governance and Traditional Affairs - Directorate: Disaster Management and Emergency Rescue Services)*

PO Box 12500  
Centralhill 6056  
Livingstone Hospital, Port Elizabeth 6000  
Training Department: Tel no 041 453 0911  
Fax no 041 456 1685  
Director EMS: AK Munilal  
Tel: 041 453 0911  
Principal EMS College: Peter Huysaen  
Tel no 041 453 0911  
Email: peter.huysaen@ehealth.gov.za  
Sub District Manager-Operations: A Botha  
Tel no 041 395 9504

### FREE STATE PROVINCE DEPARTMENT OF LOCAL GOVERNMENT AND HOUSING

*Department of Cooperative Governance  
and Traditional Affairs*  
M Butler Tel no 051 407 2001  
Cell no 074 513 0453 / 083 443 8134  
Direct fax no 051 407 2019

### GAUTENG PROVINCE DEPARTMENT OF LOCAL GOVERNMENT *(Department of Cooperative Governance and Traditional Affairs - Chief Directorate: Disaster Management and Fire & Rescue Services)*

Head: Gauteng Provincial Disaster  
Management Centre: Dr. Bongani Elias  
Sithole  
11 Janadel Avenue, Riverview Block B,  
Midrand  
Tel no 010 345 0801; Cell: 082 490 9825  
Email: elias.sithole@gauteng.gov.za  
Website: www.pdmc.gov.za

### KWAZULU-NATAL PROVINCE DEPARTMENT OF LOCAL GOVERNMENT *(Department of Cooperative Governance & Traditional Affairs )*

1st floor Mkondeni PDMC office no 82, 66  
Shortts Retreat Street, Pietermaritzburg, 3200  
Tel no 033 897 5656  
Cell no 082 897 6696  
Fax no 033 897 5825  
Acting Director General: Mrs B Mgutshini  
Email: Barbara.mgutshini@kzncogta.gov.za  
SE Ngema  
Tel no 033 846 9014  
Cell no 076 153 3685  
Email: sibongiseni.ngema@gmail.com/  
sibongiseni.ngema@kzncogta.gov.za  
Chief Director KZN Provincial Disaster  
Management Centre: JM Ndlazi  
Tel no 033 846 9006  
Cell no 081 385 8362  
Email: jonty.ndlazi@kzncogta.gov.za /  
thembeni.mncube@kzncogta.gov.za

### LIMPOPO PROVINCE DEPARTMENT OF LOCAL GOVERNMENT *(Department of Co-operative Governance, Human Settlements and Traditional Affairs* *(Directorate: Disaster Management)*

Tel Switchboard no 015 284 5000  
Head of Department: N Mosehana  
Tel no 015 284 5578  
Email: mosehanan@coghsta.limpopo.gov.za

Disaster Operations Management:  
N Shitlhangu  
Tel no 015 284 5487  
Cell 082 374 6666  
Email:  
shitlhanguws@coghsta.limpopo.gov.za

### MPUMALANGA PROVINCE DEPARTMENT OF LOCAL GOVERNMENT *(Department of Co-operative Governance, Human Settlements and Traditional Affairs* *- Directorate: Disaster Management)*

Head of Department: TP Nyoni  
Tel no 013 766 6237  
Email: tponyoni@mpg.gov.za  
Disaster Management Operations:  
S Dhudhlu  
Tel no 013 757 2081  
Fax no 013 766 844  
Cell 082 447 6001  
Email: sdhlu@mpg.gov.za

### NORTHERN CAPE PROVINCE DEPARTMENT OF LOCAL GOVERNMENT *(Department of Co-operative Governance, Human Settlements and Traditional Affairs* *- Sub-Directorate: Disaster Management & Fire Service)*

Head of PDMC : Andile Mbolekwa (Acting)  
Tel no 053 807 9700  
Cell no 082 466 1672  
Fax no 053 831 2904  
Email: AMbolekwa@ncpg.gov.za  
Assistant Director: Communication &  
Information Management: Keneilwe  
Nthutang  
Tel no 053 807 9865  
Cell no 073 442 5472  
Fax no 053 831 2904  
Email: knthutang@ncpg.gov.za  
Assistant Director: Operations: Ms  
Keetsamang Mokgele  
Tel: 053 807 9700  
Cell no 082 466 1672  
Fax no 053 831 2904  
Email: kmokgele@ncpg.gov.za  
Senior Manager: Development and  
Planning: Andile Mbolekwa  
Tel no 053 807 2843  
Cell no 071 860 4006  
E-mail: AMbolekwa@ncpg.gov.za  
Senior Administration Officer:  
Communication & Information Management:  
A Sehunelo  
Tel no 053 807 9863  
Admin Officer: Operations: Ms Ronnel  
Hendricks  
Tel: 053 807 9867

### NORTH WEST PROVINCE DEPARTMENT OF LOCAL GOVERNMENT *(Department of Co-operative Governance, Human Settlements and Traditional Affairs* *Directorate: Disaster Management)*

Head of Department: J Rikhotso  
Tel no 018 388 4446  
Cell no 083 454 3350  
Email: mrikhotso@nwpg.gov.za  
Disaster Management Operations:  
A Mosiane  
Tel no 018 388 1056  
Cell no 082 935 3115  
Fax no 018 388 1831  
Email: amosiane@nwpg.gov.za

### WESTERN CAPE PROVINCE DEPARTMENT OF LOCAL GOVERNMENT

Chief Director: Disaster Management and  
Fire Rescue Service: Colin Deiner  
Cell no 082 550 6770  
Tel no 021 937 6301  
Email: Colin.deiner@westerncape.gov.za  
Directorate: Disaster Operations  
Director: Ms JV Pandaram  
Tel no 021 937 6307  
Fax no 021 931 9031  
Cell no 083 440 9698  
Email:  
jacqueline.pandaram@westerncape.gov.za  
Deputy Director: Preparedness and  
Response: Lavenia Nicholson  
Tel no 021 937 6317  
Cell no 083 277 4221  
Fax no 021 931 9031  
Email:  
lavenia.nicholson@westerncape.gov.za  
Deputy Director: Institutional Capacity:  
Sonja Chinnian  
Cell no 082 994 1975  
Tel no 021 937 6303  
Email: Sonja.Chinnian@westerncape.gov.za  
Deputy Director: Disaster Recovery: Vacant  
Director Disaster Risk Reduction: Schalk  
Willem Carstens  
Tel no 021 937 6309  
Cell no 083 273 1372  
Email:  
Schalk.Carstens2@westerncape.gov.za  
Deputy Director: Disaster Risk Reduction:  
Nabeel Rylands  
Tel no 021 937 6353  
Cell no 078 327 3316  
Email:  
Nabeel.Rylands@westerncape.gov.za  
Deputy Director: Disaster Mitigation:  
Francisco Daams  
Tel no 021 937 6330  
Cell no 072 329 2779  
Email:  
Francisco.Daams@westerncape.gov.za

## CHAPLAINCY

### EMERGENCY SERVICES CHAPLAINCY (SOUTHERN AFRICA)

PO Box 17526, Norkem Park, 1631  
Email: Info@escsa.org.za  
Fax 0865772767  
www.escsa.org.za  
President; Rev David Niebuhr  
Deputy President; Pastor Riaan Jansen Van  
Vuuren  
Managing Director; Chaplain Rodney Berry  
National Coordinators;  
Operations; Charles Dick  
Secretarial; Charmaine Dick  
Treasury: Geraldine Smith  
Training; June Jeffrey  
Prayer; David Mtshotwane  
Regional Centres  
*Gauteng*  
Ekurhuleni; Pastor Terry Terblanche  
Cell no 082 892 5693  
Greater Johannesburg; Kerry Wetton  
Cell no 083 272 2406  
Tshwane; Tiaan Maritz  
Cell no 084 6163466  
Gauteng South (Sedibeng) June Jeffrey  
Cell no 083 750 7982  
Gauteng West; Hermien Steyn  
Cell no 082 570 7930

*Kwazulu Natal:*  
Pietermaritzburg: R Trenam  
Cell no 082 780 1173  
Vryheid: Dalene Momborg  
Cell no 0828410742  
Port Shepstone: Rev John Grubb  
Cell no 0769310285  
*Mpumalanga*  
Mpumalanga Region: Chris Potgieter  
Cell no 082 053 6776

*Northern Cape*  
Kimberley: RJ van Vuuren  
Cell no 082 415 5817  
Upington: Past. Riaan Duvenhage  
Cell no 0723415477  
*North West*  
Potchefstroom: Sarel Janse Van Rensburg  
Cell no 082 481 5998  
Brits: Vacant

*Limpopo*  
Orhgsstad Past. Emil Rainers  
Cell no 0728871696  
*Eastern Cape*  
East London: Past Niel Jacobs  
Cell no 0724232040  
*Free State*  
Free State Region Rev Gavin Hoole  
Cell no 082 466 2311

## ASSOCIATIONS / INSTITUTES

### CAPE PENINSULA FIRE PROTECTION ON

General Manager : Pierre Gallagher  
Tel no: (021) 689 7438/9  
Fax no: (021) 685 5944  
E-mail: CPFPA.manager@sanparks.org  
*East Region*  
Manager: Ruan Matthee  
Tel no: (021) 847 2254  
Fax no: (021) 847 2226  
E-mail: eastmanager@cpfpa.org.za  
*North Region*  
Manager: Riaan Fourie  
Cell no: 021 979 0060  
Fax: 021 979 0093  
Email: northmanager@cpfpa.org.za

### DISASTER MANAGEMENT INSTITUTE OF SOUTHERN AFRICA

123 Rietfontein Road Primrose Germiston,  
P O Box 7130 Primrose Hill, 1417  
Tel: (011) 822-1634 Fax: 086 652 8066  
E-mail: karin@disaster.co.za /  
disaster@disaster.co.za  
Administrator: Karin Muller

### FIRE PROFESSIONS COUNCIL OF SOUTHERN AFRICA

Chairman: Nihai F Monnye  
Cell: 076 480 3731  
Whatsup: 074 021 7787

### FIRE PROTECTION ASSOCIATION OF SOUTHERN AFRICA

PO Box 15467 Impala Park 1472  
105 Springbok Road Bartlett Boksburg  
Tel: (011) ) 397-1618/9  
Fax: (011) 397-1160  
Managing Director: Renay Sewpersad  
Email: renay@fpasa.co.za  
Head of Technical: Lynley Carols  
LynleyC@fpasa.co.za  
Executive Assistance: Neo Dichabe  
Email: neo@fpasa.co.za

### FOREST FIRE ASSOCIATION

(Private forest fire fighting association)  
Operations Centre: Nelspruit Airport  
PO Box 4555 Nelspruit 1200  
Tel no (013) 1141030  
General Manager: J Heine

### INSTITUTION OF FIRE ENGINEERS (SA)

No 16, 11th Ave, Cnr 5th Street, Houghton  
Estate, Johannesburg  
PO Box 1033 Houghton 2041  
Tel (011) 788-4329 Fax: (011) 880 6286  
Administrator: Jennifer Maritz  
Email: adminstaff@ife.org.za  
Website: www.ife.org.za

### K9 SEARCH AND RESCUE ASSOCIATION

*Gauteng Emergencies:*  
Tel no: 078 137 1073

Chairman: Helen Perry  
Cell no 082 724 2557  
Training: Kyle Gamble  
Cell no 079 879 5200  
*Western Cape Emergencies:*  
Tel no (021) 937 0300  
Chairman: Lita Potgieter  
Cell no 082 920 8783  
Training: Mariann Wilson  
Cell no 082 268 7099  
Website: www.k9sara.co.za

### KZN FIRE PROTECTION ASSOCIATION

Umbrella Fire Protection Association of KZN  
Conservation of Farmland in KZN  
Tel no (033) 330-8421  
Email: simon@kznfpa.co.za  
Operations Manager: Simon Thomas  
Cell no 082 654 4943  
Admin Manager: Denise Bouwer  
Cell no 082 777 5887  
Email: denise@kznfpa.co.za  
Dispatchers: Michelle Herbst  
Cell no 082 335 2219  
Carmen Stone: Cell no 076 422 6751

### MOUNTAIN CLUB OF SOUTH AFRICA

MCSA Secretary: Jenny Paterson  
Mobile: 083 702 6241  
Email: secretary@mcsa.org.za

### NATIONAL DISASTER MANAGEMENT CENTRE

Department of Provincial and Local  
Government  
Private Bag X804 Pretoria 0001  
Directorate: Legislation, Policy and  
Compliance Management: Pumeza Tyali  
Tel no (012) 848 4610  
Cell no: 079 505 5127  
Fax 086 773 4537  
Email: pumezat@ndmc.gov.za

### OFF ROAD RESCUE UNIT

Emergency Tel: 010 140 1911  
Email: contact@orru.co.za  
Operations:  
Email: ops.gtn@offroadrescue.co.za  
Chairman: Iain Sherwood  
Email: chairman.gtn@offroadrescue.co.za

### SAFETY FIRST ASSOCIATION

3 Kwartel Street Vorna Valley  
PO Box 321 Halfway House 1685  
Tel: (011) 701-5054  
Fax: 086 684 2664  
E-mail: admin@safety1st.co.za  
www.safety1st.co.za

### SOUTH AFRICAN BUREAU OF STANDARDS (SABS)

Tel no 0861 277 227 /012 428 7911  
Fax no 012 344 1568

Email: info@sabs.co.za  
Website: www.sabs.co.za

### SOUTHERN AFRICAN EMERGENCY SERVICES INSTITUTE

PO Box 613 Krugersdorp 1740  
Tel (011) 660-5672  
Fax (011) 660-1887 / 086 544 0008  
Email: info@saesi.com  
President: D Padayachee

### SOUTH AFRICAN PRIVATE AMBULANCE AND EMERGENCY SERVICES ASSOCIATION (AMBUSAVE)

PO Box 4051 Brakpan 1453  
Tel (011) 915-4909  
Fax (0110 915-4905  
Chief Executive Officer: OE Montalbano  
Email: dricky@ambusave.com

### SOUTHERN CAPE FIRE PROTECTION ASSOCIATION

Private Bag x 12 Knysna 6570  
Tel no: (044) 302 6912  
Fax no: 086 616 1682  
Administrator: Elske le Roux  
Email: adminfpa@telkomsa.net  
Fire Advisor / General Manager: Paul Gerber  
Email: paulge@daff.gov.za  
Tel no: (044) 302 6920  
Fax no: (044) 382 5461  
*Riversdale Office:*  
Area Manager: Charl Wade  
Email: scfpa.riversdale@gmail.com  
Tel no: (028) 713 1987  
Riversdale Extension Officer: Philip Wilken  
Email: philip.scfpa@gmail.com  
Tel no: (028) 713 1987  
*Knysna Office:*  
3rd floor of the Demar Centre  
Tel no: (044) 302 6912  
Area Manager: Dirk Smit  
Email: managerfpa@gmail.com  
Tel no: (044) 302 6908  
Fax no: 086 616 1682  
Operations Manager: Japie Hendrikz  
Email: japie.scfpa@gmail.com  
Tel no: (044) 382 2062  
Fax no: 086 616 1682

### WESTERN CAPE FIREFIGHTERS ASSOCIATION

1st Floor, 71 Klipfontein Road  
Rondebosch 7700  
Tel no 021 6869303  
Fax no 021 6861547  
Robin Fitzgerald  
Cell no 078 6241841  
Email: wcfirefighters@mweb.co.za

## INDEX TO DEPARTMENTS / SERVICES

ABAQULUSI MUNICIPALITY .....	127	DR RUTH S MOMPATI DISTRICT MUNICIPALITY .....	137
AFRICAN RAINBOW MINERALS .....	144	EAST LONDON AIRPORT .....	144
AIRPORTS COMPANY LIMITED .....	144	DUNLOP INDUSTRIAL PRODUCTS .....	146
AIRPORTS TRAINING ACADEMY .....	145	EDUMBE PROTECTION SERVICES .....	127
ALFRED DUMA PUBLIC SAFETY .....	127	EKURHULENI METROPOLITAN MUNICIPALITY .....	124
ALGOABAY FIRE SERVICES .....	145	ELIAS MOTSOLEDI LOCAL MUNICIPALITY .....	131
AMAHLATHI FIRE DEPARTMENT .....	117	EMADLANGENI PROTECTION SERVICES .....	128
AMATHOLE FIRE DEPARTMENT .....	117	EMAKHAZENI MUNICIPALITY FIRE DEPARTMENT .....	133
ANGLO AMERICAN CORPORATION OF SA LTD .....	145	EMALAHLENI LOCAL MUNICIPALITY (E CAPE) .....	118
ANGLO AMERICAN THERMAL COAL .....	145	EMALAHLENI EMERGENCY SERVICES (MPUMALANGA) .....	133
ANGLO AMERICAN COAL MOZAMBIQUE .....	145	EMERGENCY MEDICAL SERVICES .....	154
ANGLO AMERICAN KUMBA IRONORE MINE .....	145	EMFULENI FIRE AND EMERGENCY SERVICES .....	125
ANGLO AMERICAN OPERATIONS LTD .....	145	EMTHANJENI MUNICIPALITY .....	135
ANGLO AMERICAN POLOKWANE .....	145	ENGEN PETROLEUM LTD .....	146
ANGLOGOLD ASHANTI LIMITED .....	145	ENGEN REFINERY .....	146
ANKER COAL .....	145	ENOCH MGJIMA FIRE AND EMERGENCY SERVICES .....	118
ASSMANG LIMITED BLACK ROCK .....	145	EPHRAIM MOGALE FIRE DEPARTMENT .....	131
ASSMANG IRON ORE .....	145	ESKOM .....	146
ASSOCIATIONS .....	156	ETHEKWINI FIRE AND RESCUE SERVICES .....	128
BA-PHALABORWA PROTECTION SERVICES .....	131	FEZILE DABI FIRE DEPARTMENT .....	120
BARPLATS MINE LTD .....	145	FINE CHEMICALS CORP .....	147
BEAUFORT WEST FIRE DEPARTMENT .....	140	FIRE PROFESSIONS COUNCIL OF SOUTHERN AFRICA .....	156
BELA BELA FIRE DEPARTMENT .....	131	FIRE PROTECTION ASSOCIATION OF SOUTHERN AFRICA .....	156
BERGRIVIER MUNICIPALITY FIRE DEPARTMENT .....	140	FOODCORP .....	147
BHP BILLITON HOTAZEL MANGANESE MINE .....	145	FOREST FIRE ASSOCIATION .....	147
BHP BILLITON ENERGY COAL SA .....	146	FOREST FIRE FIGHTING ASSOCIATION .....	156
BITOU LOCAL MUNICIPALITY PUBLIC SAFETY .....	140	FOSKOR .....	147
BLUE CRANE MUNICIPALITY FIRE DEPARTMENT .....	117	GAMA GARA MUNICIPALITY .....	135
BOJANALA PLATINUM DISTRICT MUNICIPALITY .....	137	GARDEN ROUTE DISTRICT MUNICIPALITY .....	141
BOMBELA OPERATING COMPANY .....	146	GA-SEGONAYANA FIRE DEPARTMENT .....	136
BP SOUTH AFRICA .....	146	GEORGE AIRPORT .....	144
BRAM FISCHER INTERNATIONAL AIRPORT .....	144	GEORGE LOCAL MUNICIPALITY .....	141
BREDEE VALLEY MUNICIPALITY FIRE AND RESCUE .....	140	GLENCORE .....	147
BUFFALO CITY METROPOLITAN MUNICIPALITY .....	117	GOLDFIELDS LTD .....	147
CAPE PENINSULA FIRE PROTECTION ASSOCIATION .....	156	GOODYEAR SOUTH AFRICA .....	147
CAPE TOWN CITY FIRE AND RESCUE SERVICES .....	141	GOVAN MBEKI MUNICIPALITY FIRE DEPARTMENT .....	133
CAPE TOWN INTERNATIONAL AIRPORT .....	144	GREAT KEI MUNICIPALITY .....	118
CAPE WINELANDS DISTRICT MUNICIPALITY .....	140	HARMONY GOLD MINE .....	147
CHAPLAINCY .....	155	HESSEQUA MUNICIPALITY FIRE DEPARTMENT .....	141
CHEVRON SA .....	146	IDWALA INDUSTRIAL HOLDINGS .....	147
CHIEF ALBERT LUTHULI FIRE DEPARTMENT .....	132	IMPALA PLATINUM LTD .....	148
CITY OF CAPE TOWN FIRE AND RESCUE SERVICES .....	141	IMPALA PLATINUM REFINERY .....	148
CITY OF JOHANNESBURG METROPOLITAN MUNICIPALITY .....	125	INKOSI LANGA LOCAL MUNICIPALITY .....	128
CITY OF TSHWANE EMERGENCY SERVICES .....	126	INSTITUTION OF FIRE ENGINEERS .....	156
DAWD KRUIPER FIRE AND RESCUE SERVICE .....	135	INSTITUTES & ASSOCIATIONS .....	156
DE BEERS CONSOLIDATED MINES .....	146	INXUBA FIRE DEPARTMENT .....	118
DENEL INDUSTRIAL PROPERTIES .....	146	JB MARKS FIRE BRIGADE .....	137
DEPARTMENT OF DEFENCE .....	153	JOE GOABI DISTRICT MUNICIPALITY FIRE DEPARTMENT .....	118
DEPARTMENT OF HEALTH - EMS .....	154	JOHANNESBURG MUNICIPALITY EMERGENCY SERVICES .....	125
DEPARTMENT OF WATER & FORESTRY AFFAIRS .....	152	K9 SEARCH AND RESCUE ASSOCIATION .....	156
DIHLABENG PUBLIC SAFETY DEPARTMENT .....	120	KAI GARIB FIRE DEPARTMENT .....	136
DISASTER MANAGEMENT COMMITTEE .....	155	KGETLENG FIRE DEPARTMENT .....	137
DISASTER MANAGEMENT INSTITUTE OF SOUTH AFRICA .....	156	KIMBERLEY AIRPORT .....	144
DISASTER MANAGEMENT CENTRE CITY OF CAPE TOWN .....	155	KING SABATA DALINDYEBO .....	118
DISASTER MANAGEMENT EASTERN CAPE .....	155	KING SHAKA INTERNATIONAL AIRPORT .....	144
DISASTER MANAGEMENT FREE STATE .....	155	KNYSNA LOCAL FIRE DEPARTMENT .....	142
DISASTER MANAGEMENT GAUTENG .....	155	KOKSTAD FIRE AND RESCUE SERVICES .....	128
DISASTERMANAGEMENT KWAZULU NATAL .....	155	KOORNFONTEIN MINES .....	148
DISASTER MANAGEMENT LIMPOPO .....	155	KOPANONG LOCAL MUNICIPALITY FIRE DEPARTMENT .....	120
DISASTER MANAGEMENT MPUMALANGA .....	155	KOUGA FIRE DEPARTMENT .....	118
DISASTER MANAGEMENT NORTH WEST .....	155	KOUKAMMA MUNICIPALITY .....	119
DISASTER MANAGEMENT NORTHERN CAPE .....	155	KWADUKUZA FIRE AND EMERGENCY SERVICES .....	128
DISASTER MANAGEMENT WESTERN CAPE .....	155	KWAZULUNATAL FIRE PROTECTION ASSOCIATION .....	155
DITSABOTLA FIRE DEPARTMENT .....	137	LANGEBERG FIRE DEPARTMENT .....	142
DRAKENSTEIN FIRE AND RESCUE .....	141	LEKWA FIRE AND RESCUE SERVICE .....	134
DR BEYERS NAUDE FIRE DEPARTMENT .....	117	LEKWA TEEMANE FIRE DEPARTMENT .....	138
DR PIXLEY KA ISAKA FIRE SERVICES .....	133	LESEDI MUNICIPALITY FIRE AND RESCUE SERVICES .....	126



# FIRE DEPARTMENT LOCATIONS

LETSEMENG FIRE DEPARTMENT	.121	SA AIRFORCE	.153
MADIBENG FIRE DEPARTMENT	.138	SA NAVY	.153
MAFUBE COAL MINING	.148	SAFETY FIRST ASSOCIATION	.156
MAKANA FIRE AND RESCUE SERVICES	.119	SAFRIPOL	.149
MALANDELA SECURITY SERVICES	.148	SAKHISIZWE MUNICIPALITY FIRE DEPARTMENT	.120
MALUTI A PHOFUNG	.121	SALDANHA BAY FIRE DEPARTMENT	.143
MAMUSA MUNICIPALITY	.138	SAMANCOR LTD	.149
MANGAUNG MUNICIPALITY FIRE DEPARTMENT	.121	SAMANCOR EASTERN CHROME MINES	.149
MANTSOPA MUNICIPALITY DISASTER MANAGEMENT	.121	SANRAL	.149
MAQUASSIE FIRE DEPARTMENT	.138	SAPPI KRAFT	.149
MARULA PLATINUM	.148	SAPREF	.149
MASILONYANA MUNICIPALITY FIRE DEPARTMENT	.121	SASOL INFRACHEM	.149
MATATIELE PUBLIC SAFETY	.119	SASOL MINING	.150
MATJHABENG EMERGENCY SERVICES	.122	SASOL SECUNDA SERVICES	.150
MATLOSANA LOCAL MUNICIPALITY	.138	SASOL TECHNOLOGY PROCESS ENGINEERING	.150
MATZIKAMA MUNICIPALITY	.142	SCAW METALS	.150
MBOMBELA FIRE AND RESCUE SERVICES	.134	SETSOTO FIRE SERVICES	.123
MERCEDES BENZ SA	.148	SIBANYE GOLD SHARED SERVICES	.150
METSIMAHOLO FIRE DEPARTMENT	.122	SIYATHEMBA FIRE DEPARTMENT	.136
MINE RESCUE SERVICES	.148	SOL PLAATJIE EMERGENCY SERVICES	.136
MKHONDO FIRE DEPARTMENT	.134	SOUTH AFRICAN BREWERIES	.150
MOGALAKWENA FIRE DEPARTMENT	.131	SOUTHERN AFRICAN EMERGENCY SERVICES INSTITUTE	.156
MOHOKARE FIRE DEPARTMENT	.122	SOUTHERN AFRICAN PRIVATE AMBULANCE ASSOCIATION	.156
MONDI FIRE & EMERGENCY SERVICES	.148	STEVE TSHWETE FIRE AND RESCUE SERVICES	.135
MOOKGOPHONG FIRE DEPARTMENT	.131	STELLENBOSCH FIRE AND RESCUE DEPARTMENT	.143
MOPANI DISTRICT MUNICIPALITY	.131	SUN CITY FIRE AND EMERGENCY SERVICES	.150
MOQHAKA MUNICIPALITY EMERGENCY SERVICES	.123	SUNDAYS RIVER VALLEY MUNICIPALITY FIRE DEPT	.120
MOSSSEL BAY LOCAL MUNICIPALITY FIRE AND RESCUE	.142	SWARTLAND FIRE SERVICE	.143
MOUNTAIN CLUB OF SA	.156	SWELLEDAM LOCAL MUNICIPALITY	.143
MPOFANA MUNICIPALITY	.129	TAU LEKOA MINE	.150
MSUKALIGWA PUBLIC SAFETY DEPARTMENT	.134	THABA CHWEU FIRE DEPARTMENT	.135
MSUNDUZI FIRE AND RESCUE SERVICES	.129	THABAZIMBI MUNICIPALITY PROTECTION SERVICE	.132
MTUBATUBA FIRE DEPARTMENT	.129	THEEWATERSKLOOF MUNICIPALITY	.145
MUSINA EMERGENCY SERVICES	.132	THEMBELIHLE MUNICIPALITY FIRE DEPARTMENT	.136
NALA EMERGENCY SERVICES	.123	TOKOLOGO MUNICIPALITY FIRE SERVICE	.124
NAMAKWA DISTRICT MUNICIPALITY FIRE DEPARTMENT	.136	TOTAL SOUTH AFRICA	.150
NATIONAL DISASTER MANAGEMENT CENTRE	.156	TRANSNET ENGINEERING	.150
NATREF	.148	TRANSNET FREIGHT RAIL HAZMAT FIRE	.150
NDLAMBE FIRE DEPARTMENT	.119	TRANSNET NATIONAL PORTS AUTHORITY	.151
NDMC MEMBERS	.154	TSANTSABANE MUNICIPALITY FIRE DEPARTMENT	.136
NECSA	.148	TSHWANE EMERGENCY SERVICES	.126
NELSON MANDELA BAY FIRE AND EMERGENCY SERVICES	.119	TSWANG LOCAL MUNICIPALITY	.139
NEWCASTLE FIRE AND DISASTER MANAGEMENT	.129	TSWELOPELE MUNICIPALITY EMERGENCY SERVICE	.124
NGAKA MODIRI MOLEMA DISTRICT MUNICIPALITY	.139	TZANEEN MUNICIPALITY	.132
NGWATHE PROTECTION SERVICES	.123	UBUHLEBEZWE FIRE DEPARTMENT	.130
NKETOANA FIRE DEPARTMENT	.123	UMDONI PROTECTION SERVICE	.130
NKOMATI MINE	.148	UMHLATHUZE FIRE DEPARTMENT	.130
OFF ROAD RESCUE UNIT	.156	UMLALAZI PROTECTION SERVICES	.130
OKHAHLAMBA FIRE DEPARTMENT	.129	UMNGENI FIRE DEPARTMENT	.130
OR TAMBO DISTRICT MUNICIPALITY FIRE AND EMERGENCY	.119	UMSOBOMVU MUNICIPALITY FIRE DEPARTMENT	.137
OR TAMBO INTERNATIONAL AIRPORT	.144	UMUZIWABANTU MUNICIPALITY	.130
OUTDSHOORN FIRE STATION	.142	UMVOTI MUNICIPALITY	.130
OVERBERG FIRE BRIGADE	.143	UPINGTON INTERNATIONAL AIRPORT	.144
OVERSTRAND LOCAL MUNICIPALITY	.143	UMZINYATHI FIRE DEPARTMENT	.131
PETRA DIAMONDS	.148	UPHONGOLA PROTECTION SERVICE	.131
PETROSA FIRE AND EMERGENCY SERVICES	.148	VENTERSDORP FIRE DEPARTMENT	.139
PHUMELELA FIRE DEPARTMENT	.123	VIRGINIA AIRPORT	.150
PILANSBERG INTERNATIONAL AIRPORT	.144	VHEMBE DISTRICT MUNICIPALITY	.132
PIONEER FOODS	.149	VOLKSWAGEN SOUTH AFRICA	.151
POLOKWANE FIRE AND EMERGENCY SERVICES	.132	WALTER SISULU UNIVERSITY	.151
PORT ELIZABETH AIRPORT	.144	WATER AFFAIRS AND FORESTRY DEPARTMENT	.152
PPC LIME LIMITED	.149	WATERBERG DISTRICT MUNICIPALITY	.132
PUREGAS	.149	WATERBERG FIRE AND RESCUE	.151
RAMOTSHERE LOCAL MUNICIPALITY	.139	WELGEMEEND COLLIERY	.152
RAY NKONYENI MUNICIPALITY FIRE DEPARTMENT	.129	WEST COAST DISTRICT MUNICIPALITY	.144
RAYMOND MHLABA LOCAL MUNICIPALITY	.120	WEST RAND DISTRICT FIRE DEPARTMENT	.127
RICHARDS BAY COAL TERMINAL	.149	WESTERN CAPE FIRE FIGHTING ASSOCIATION	.156
ROSSING URANIUM	.149	WILMAR CONTINENTAL MILLS	.152
ROYAL BAFOKENG PLATINUM	.149	WITZENBERG PROTECTION SERVICE	.143
RUSTENBURG FIRE DEPARTMENT	.139		

CITY	MUNICIPALITY	CITY	MUNICIPALITY
ABERDEEN	.CAMDEBOO	FICKSBURG	.SETSOTO
ADELAIDE	.RAYMOND MHLABA	FOCHVILLE	.MERAFONG
AKASIA	.TSHWANE	FRANKFORT	.FEZILE DABI
ALANRIDGE	.MATJHABENG	GANSBAAI	.OVERSTRAND
ALBERTON	.EKURHULENI	GARDEN ROUTE	.EDEN/GEORGE
ALIWAL NORTH	.MALETSWAI	GEORGE	.EDEN
ASHTON	.LANGEBERG	GERMISTON	.EKURHULENI
BARBERTON	.UMJINDI	GIYANI	.MOPANI
BARKLY EAST	.JOE GOABI	GLENCOE	.ENDUMENI
BEDFORD	.RAYMOND MHLABA	GRAAFF REINET	.DR BEYERS NAUDE
BELFAST	.EMAKHAZENI	GRABOUW	.OVERBERG
BENONI	.EKURHULENI	GRAHAMSTOWN	.MAKANA
BERGVILLE	.OKHAHLAMBA	GRASKOP	.THABA CHWEU
BETHAL	.GOVAN MBEKI	GREYTOWN	.UMVOTI
BETHLEHEM	.DIHLABENG	GROBLERSDAL	.ELIAS MOTSOLEDI
BETHULIE	.KOPANONG	HARDING	.UMUZIWABANTU
BLAAUBERG	.CITY OF CAPE TOWN	HARRISMITH	.MALUTI A PHOFUNG
BLOEMFONTEIN	.MANGAUNG	HEIDELBERG	.LESEDI
BLOEMHOF	.LEKWA TEEMANE	HEILBRON	.NGWATHE
BOKSBURG	.EKURHULENI	HENNENMAN	.MATJHABENG
BOSHOF	.TOKOLOGO	HERMANUS	.OVERSTRAND
BOTHAVILLE	.NALA	HIBBERDENE	.RAY NKONYENI
BRAKPAN	.EKURHULENI	HIGHVELD RIDGE	.BARNE MOLOKWANE
BRANDFORT	.MASILONYANA	HIGHLANDS	.EMAKHAZENI
BREYTEN	.MSUKALIGWA	HOBHOUSE	.MANTSOPA
BRITS	.MADIBENG	HOOPSTAD	.TSWELOPELE
BRONKHORSTSPRUIT	.KUNGWINI	HOPETOWN	.THEMBELIHLE
BULTFONTEIN	.TSWELOPELE	HUMANSDORP	.KOUGA
BURGERSDORP	.GARIEP	HOWICK	.UMGENI
CALEDON	.THEE WATERSKLOOF	IMPENJATI/SOUTHBROOM	.HIBISCUS COAST
CARLETONVILLE	.WEST RAND DISTRICT	IXOPO	.UBUHLEBEZWE
CAROLINA	.CHIEF ALBERT LUTHULI	JACOBSDAL	.LETSEMENG
CATHCART	.AMAHLATHI	JAGERSFONTEIN	.KOPANONG
CENTURION	.TSHWANE	JEFFREYS BAY	.KOUGA
CERES	.WITZENBERG	JOUBERTINA	.KOUKAMMA
CHRISTIANA	.LEKWA TEEMANE	KAKAMAS	.KAI GARIB
CLOCOLAN	.SETSOTO	KATHU	.GAMA GARA
COLESBERG	.UMSOBOMVU	KEMPTON PARK	.EKURHULENI
COLIGNY	.DITSABOTLA	KENTON ON SEA	.NDLAMBE
CORNELIA	.MAFUBE	KIMBERLEY	.SOL PLAATJIE
CRADOCK	.INXUBA	KING WILLIAMS	.BUFFALO
DE AAR	.EMTHANJENI	KINROSS	.GOVAN MBEKI
DEALESVILLE	.TOKOLOGO	KIRKWOOD	.SUNDAY'S RIVER VALLEY
DELAREYVILLE	.TSWANG	KLERKSDORP	.MATLOSANA
DELMAS	.EMAKHAZENI	KOFFIEFONTEIN	.LETSEMENG
DENEYSVILLE	.METSIMAHOLO	KOMGA	.GREAT KEI
DEVON	.LESEDI	KOPPIES	.NGWATHE
DEWETSDORP	.NALEDI	KOSTER	.KGETLENG
DOLPHIN COAST	.KWADUKUZA	KRIEL	.EMALAHLENI
DORDRECHT	.EMALAHLENI	KROONSTAD	.MOQHAKA
DUNDEE	.UMZINYATHI	KRUGERSDORP MOGALE	.WEST RAND DISTRICT
DURBAN	.ETHEKWINI	KURUMAN	.GASEGONYANA
EAST LONDON	.BUFFALO	LADYBRAND	.MANTSOPA
EDENBURG	.KOPANONG	LADYFRERE	.EMALAHLENI
EDENVALE	.EKURHULENI	LADYSMITH	.ALFRED DUMA
EDENVILLE	.NGWATHE	LANGEBERG	.HASSEQUA
ELLIOT	.SAKHISIZWE	LEANDRA	.GOVAN MBEKI
EMPANGENI	.UMHLATHUZE	LEEUDORINGSTAD	.MAQUASSIE
ERMELO	.MSUKALIGWA	LEKOA VAAL	.SEDIBENG
ESHOWE	.UMLALAZI	LICHTENBURG	.DITSABOTLA
ESTCOURT	.UMTSHEZI	LOUIS TRICHARDT	.VHEMBE
EVANDER	.GOVAN MBEKI	LUCKOFF	.LETSEMENG
FAURESMITH	.KOPANONG	LYDENBURG	.THABA CHWEU

CITY	MUNICIPALITY
MAFIKENG	.NGAKA MODIRI
MAKHADO	.VHEMBE
MALMESBURY	.SWARTLAND
MARBLE HALL	.EPHRAIM MOGALE
MARGATE	.HIBISCUS COAST
MARQUARD	.SETSOTO
MARYDALE	.SIYATHEMBA
MEMEL	.PHUMELELA
MESSINA	.MUSINA
MIDDELBURG	.INXUBA
MIDDLEBURG (MPUMALANGA)	.STEVE TSHWETE
MMABATHA	.MAFIKENG
MOOI RIVER	.MPOFANA
MONTAGU	.BREEDERIVER
MOORREESBURG	.WEST COAST
MTHATHA	.KING SABATA DALINDYEBO
MTUNZINI	.UMLALAZI
NABOOMSPRUIT	.MOOKGOPHONG
NELSPRUIT	.MBOMBELA
NIGEL	.EKURHULENI
ODENDAALSRUS	.MATJHABENG
ORANJEVILLE	.METSIMAHOLO
ORKNEY	.KLERKSDORP
OTTOSDAL	.TSWAING
PAARL	.DRAKENSTEIN
PARYS	.NGWATHE
PAUL ROUX	.DIHLABENG
PAULPIETERSBURG	.EDUMBE
PENNINGTON	.UMDONI
PETRUS STEYN	.NKETOANA
PETRUSBURG	.LETSEMENG
PHALABORWA	.BA-PHALABORWA
PHILIPPOLIS	.KOPANONG
PIET RETIEF	.MKHONDO
PIETERMARITZBURG	.MSUNDUZI
PIETERSBURG	.POLOKWANE
PIKETBERG	.BERGRIVIER
PLETTENBERG	.BITOU
PONGOLA	.UPONGOLA
PORT ALFRED	.NDLAMBE
PORT SHEPSTONE	.HIBISCUS COAST
PORT ELIZABETH	.NELSON MANDELA
PORTERVILLE	.BERGRIVIER
POSTMASBURG	.TSANTSABANE
POTCHEFSTROOM	.TLOKWE
POTGIETERSSRUS	.MOGALAKWENA
PRETORIA	.TSHWANE
PRIESKA	.SIYATHEMBA
QUEENSTOWN	.ENOCH MGIJIMA
QWAQWA	.MALUTI AR PHOFUNG
RANDFONTEIN	.WEST RAND DISTRICT
REDDERSBURG	.KOPANONG
REITZ	.NKETOANA
RICHARDS BAY	.UMHLATHUZE
RIEBECK KASTEEL	.SWARTLAND
RIVERSDAL	.HASSEQUA
ROUXVILLE	.MOHOKARE
RUSTENBURG	.BOJANALA PLATINUM
SABIE	.THABA CHWEU
SASOLBURG	.METSIMAHOLO
SCHWEIZER RENEKE	.MAMUSA
SCOTTBURGH	.UMDONI
SECUNDA	.GOVAN MBEKI

CITY	MUNICIPALITY
SCOTTBURGH	.UMDONI
SEDFIELD	.KNYSNA
SENEKAL	.SETSOTO
SMITHFIELD	.MOHOKARE
SOMERSET EAST	.BLUE CRANE ROUTE
SOUTHBROOM	.HIBISCUS COAST
SOUTPAN	.MASILONYANA
SPRINGBOK	.NAMAKWA
SPRINGFONTEIN	.KOPANONG
SPRINGS	.EKURHULENI
STANDERTON	.LEKWA
STANGER	.KWADUKUZA
STELLENBOSCH	.CAPE WINELANDS
STEYNSRUS	.MOQHAKA
ST FRANCIS BAY	.KOUGA
STILFONTEIN	.KLERKSDORP
STUTTERHEIM	.AMAHLATHI
SWARTRUGGENS	.KGETLENG
SWELLENDAM	.OVERBERG
THABA NCHU	.MANGAUNG
THEUNISSEN	.MASILONYANA
TOUWSRIVER	.BREDEVALLEI
TROMPSBURG	.KOPANONG
TWEELING	.MAFUBE
TWEESPRUIT	.MANTSOPA
TZANEEN	.MOPANI
UPINGTON	.DAWID KRUIPER
UITENHAGE	.NELSON MANDELA
UTRECHT	.EMADLANGENI
VANDERBIJLPARK	.EMFULENI
VAN STADENSURUS	.NALEDI
VENTERSBURG	.MATJHABENG
VENTERSSTAD	.GARIEP
VEREENIGING	.EMFULENI
VILJOENSKROON	.MOQHAKA
VILLIERS	.MAFUBE
VIRGINIA	.MATJHABENG
VOLKSRUST	.DR PIXLEY KA ISAKA
VREDE	.PHUMELELA
VREDEFORT	.NGWATHE
VREDENBURG	.DR RUTH S MOMPATI
VREDENDAL	.MATZIKAMA
VRYHEID	.ABAUQULUSI
WAKKERSTROOM	.SEME
WARDEN	.PHUMELELA
WARMBATHS	.BELA BELA
WEENEN	.INKOSI LANGA MABELELE
WELKOM	.MATJHABENG
WEPENER	.NALEDI
WESSELSBRON	.NALA
WESTONARIA	.WEST RAND DISTRICT
WHITE RIVER	.MBOMBELA
WILLOWMORE	.DR BEYERS NAUDE
WINBURG	.MASILONYANA
WITBANK	.EMALAHLENI
WITSIESHOEK	.MALUTI PHOFUNG
WOLMARANSSTAD	.MAQUASSI HILLS
WOLSELY	.WITZENBERG
WORCESTER	.BREDEVALLEI
ZASTRON	.MOHOKARE
ZEEERUST	.RAMOTSHERE

# Sava



## Flat-Form Lifting Bags

### Perfected lifting bags

Sava flat bags are perfected standard lifting bags. Due to the construction the entire bags surface lifts evenly providing a constant lifting force independent of the lifting height.

### Levelled bag surface

The levelling bag surface provides a larger contact surface and an improved safety during use, especially when two or even three bags are placed on top of each other.

### Excellent construction

Made from an excellent wear resistant rubber compound and are Kevlar Kord reinforced.

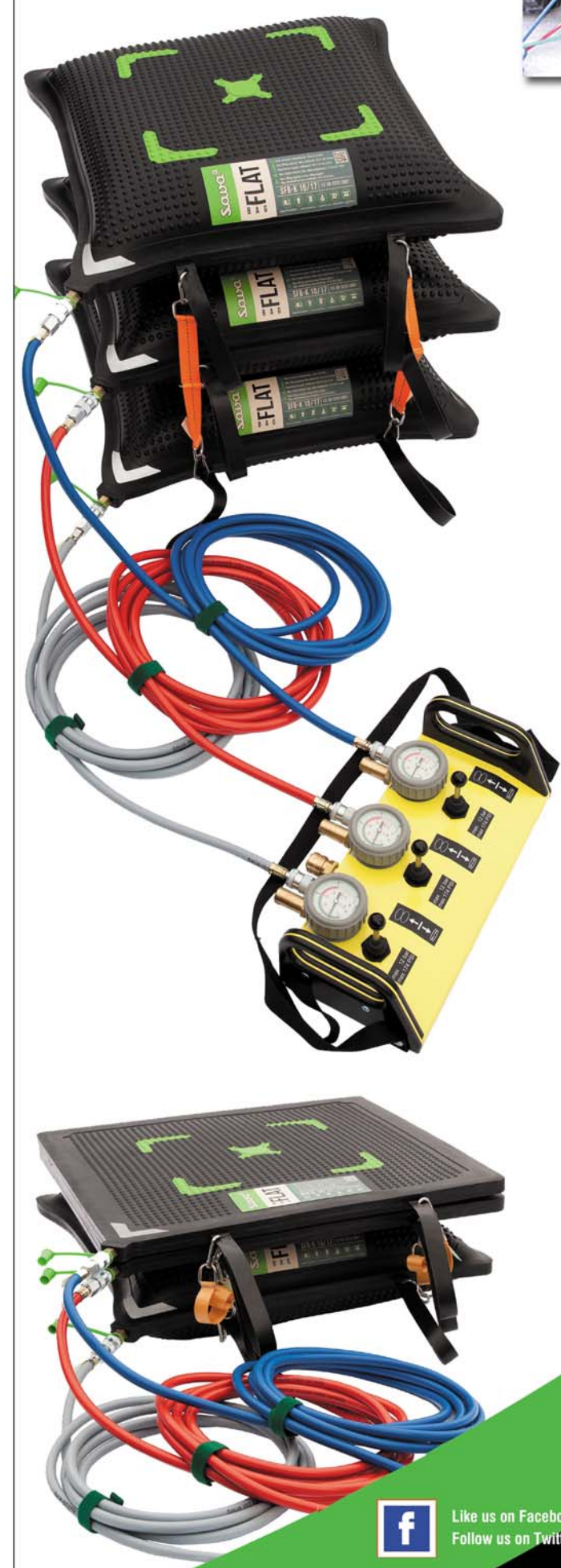

info@vanguardafrica.co.za  
www.vanguardfire.co.za

Durban: +27 (0)31 564 3200  
Port Elizabeth: +27 (0)41 451 2461



Like us on Facebook: facebook.com/Vanguardfs  
Follow us on Twitter: twitter.com/@vanguardfs



For further information contact:  
Dharmesh Lakmidas  
Cell: +27 (0) 72 098 0791  
Tel: +27 (0) 11 218 8686  
Email: Dharmesh.lakmidas@dupont.com  
[www.safespec.nomex.ae](http://www.safespec.nomex.ae)



## WHY DOES THIS FABRIC PROTECT YOU EVEN AFTER 100 WASHES BECAUSE IT'S DUPONT™ PROTERA™, THE FABRIC WITH BUILT IN ELECTRIC ARC PROTECTION.

YOU CAN FEEL THE COMFORT IN THE FABRIC. But it's not just comfortable. It's more durable. DuPont™ PROTERA™ garments stand up better to repeated washing than FR cotton nylon blend garments of similar weight. And like DuPont™ NOMEX® brand fiber, it offers inherent electric arc protection that can't be washed out or worn away.